

90cm 5 zone induction cooktop with SenseFry, MaxiZone, Bridge zone, PowerBoost, and Hob2Hood capability

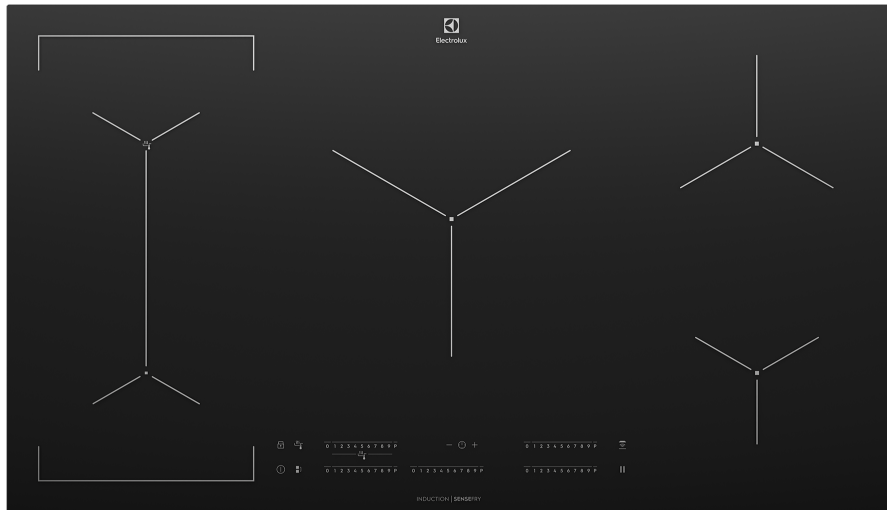

Product Details

FEATURES

SenseFry

MaxiZone

Bridge function

PowerBoost

Touch and slide controls
Touch the control bar at the
necessary heat setting

Hob2Hood technology

STOP + GO function

Timer and minute minder

Auto warm up function

Auto pot detection

Safety child lock

BENEFITS

EVEN FRYING. AUTOMATICALLY.

SenseFry measures heat levels and makes automatic adjustments under the pan to maintain the ideal temperature for even cooking results. Now its easy for you to whip-up evenly browned pancakes and juicy steaks at home.

COMBINE ZONES FOR MORE FLAVOUR

The Bridge function allows you to combine two separate cooking zones to create a single large surface. With the temperature and time settings automatically aligned, its ideal for making the most of planchas or roasting pots.

SEAR. STIR-FRY. BOIL.

The PowerBoost function gives you an intense heat boost when needed, before automatically dropping to the highest power level. Perfect for pan searing fish, stir-frying crunchy vegetables, or bringing water to the boil quickly.

HANDS-FREE HOOD

Hob2Hood automatically switches on your extractor hood when you start cooking and adjusts the fan speed based on how you are using your hob. This means you can boil, sear or stir-fry without having to touch your hood with greasy fingers.

INTUITIVE TOUCH CONTROLS

Sensitive touch controls take you from simmering to boiling and back again, almost instantly. This controllability allows you to apply precise changes that can take your dishes from tasty to truly delicious. Pan-sear steak with intense heat, and then instantly drop the temperature down to protect that beautifully juicy, medium-rare texture.

Enjoy the space and freedom to cook what you want
Use large pots and pans like a professional chef. The extra large MaxiZone on this hob gives you the freedom to effortlessly prepare all kinds of dishes that need a large pan with consistent heat, like that delicious paella youve been wanting to cook.

Specifications

PRODUCT PROFILE

Domestic warranty details (yrs)	2
Cooktop type	induction
Materials/Colour	black ceramic glass

DIMENSIONS

Total product height (mm)	51
Total product width (mm)	910
Total product depth (mm)	520
Cut out width (mm)	880
Cut out depth (mm)	490

CONTROLS

Controls of Cooktops	Touch and Slide controls
Position of controls	front
Functions of Cooktops	stop and go,automatic warm up,timer,Keep warm function,cooking timer with acoustic signal,automatic switch off,Hob2Hood,MaxiZone,Bridging,PowerBoost
Indicators/display	fault indicator,3 level residual heat indicator

ELEMENTS/BURNERS

LEFT FRONT ZONE

Left front zone	induction
Left front Watts	2300
Left front boost watts	3200

CONTROLS

Features of Cooktop	safety cut off,overheating protection,electronic timer,minute minder,function lock,hot surface indicator,auto pot sensors,child safety device lock,MaxiZone,Hob2Hood,Bridge zone,SenseFry
---------------------	---

Timer of Cooktop	programmable 99min,auto off,countdown,Minute minder
------------------	---

LEFT REAR ZONE

Left rear zone	induction
----------------	-----------

Left rear watts	2300
-----------------	------

CENTRE FRONT ZONE

Centre front zone	MaxiZone
-------------------	----------

Centre front Watts	3500
--------------------	------

RIGHT FRONT ZONE

Right front zone	induction
------------------	-----------

Right front Watts	1400
-------------------	------

RIGHT REAR ZONE

Right rear zone	induction
-----------------	-----------

Right rear watts	1800
------------------	------

ELECTRICAL SPECIFICATIONS

Connected load KW	7.4
-------------------	-----

Type of connection	hardwired
--------------------	-----------

SHIPPING

Shipping Volume (m3)	0.071
----------------------	-------

Shipping Weight (Kg)	18.8
----------------------	------

SHIPPING

Pack Dimensions Height (mm)	118
--------------------------------	-----

Pack Dimension Width (mm)	1000
------------------------------	------

Pack Dimension Depth (mm)	600
------------------------------	-----

Dimensions

Model:
EHI955BE

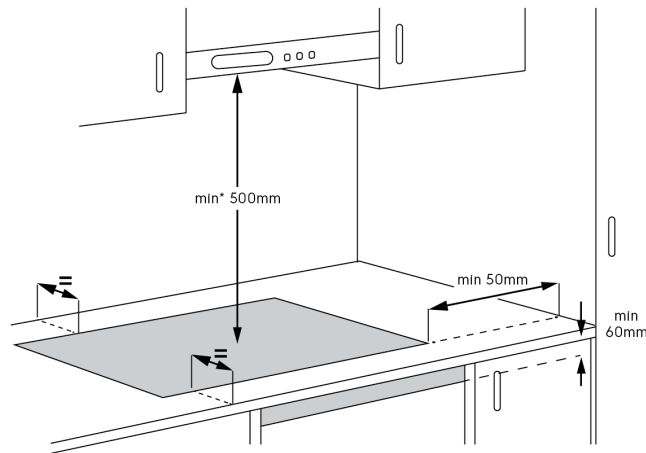
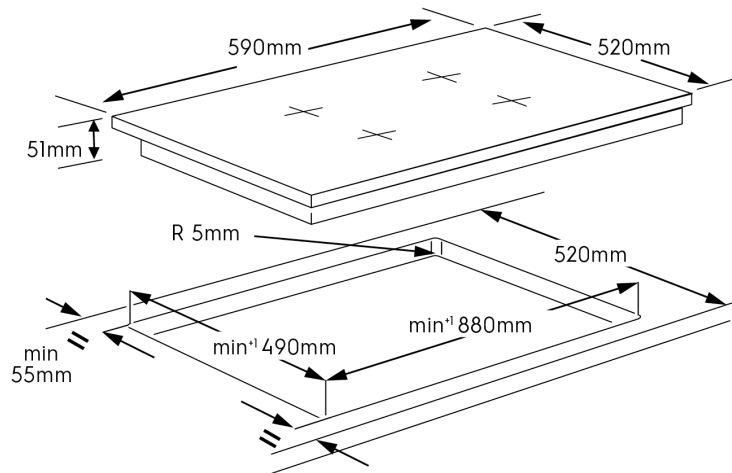

© 2021 Electrolux S.E.A PTE. LTD. E_DIM_EHI955BE_Sep21

Terms and Conditions

IMPORTANT

This is a guide of product dimensions only. For complete installation instructions, refer to the manual provided with product.

PRODUCT INFORMATION

The descriptors and illustrations in this publication apply to the specific products and models described as at the date of issue. Under our policy of continuous product development, product specifications may change without notice. Prospective purchasers should therefore check with their retailer to ensure this publication correctly describes the products that are being offered for sale. All information supplied is to be used for general reference purposes only and is on the understanding that Electrolux Home Products Pty Ltd (Australia) and Electrolux (NZ) Ltd (New Zealand) will not be liable for any loss, liability or damage of whatever kind arising as a result of reliance on such information. Colours of products illustrated are as close as printing limitations allow. Electrolux will at all times comply with its obligations pursuant to law including Trade Practices (Australian Consumer Law) Act and Regulations.

WARRANTY

This warranty only applies to Appliances purchased and used in Australia or New Zealand and used in normal domestic applications and is in addition to (and does not exclude, restrict, or modify in any way) any non-excludable statutory warranties in Australia or New Zealand. All warranties are subject to the conditions set out in the warranty card accompanying the product when purchased.

ELECTROLUX HOME PRODUCTS AUSTRALIA

telephone: 1300 363 640

fax: 1800 350 067

email: customercare@electrolux.com.au

web: www.electrolux.com.au

ELECTROLUX HOME PRODUCTS NEW ZEALAND

telephone: 09 573 2230

fax: 09 573 2221

email: customercare@electrolux.co.nz

web: www.electrolux.co.nz