



*Thinking of you*  
**Electrolux**

user manual



Iron Aid  
Condenser Dryer

EDI 96150 W

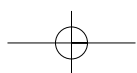
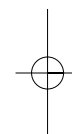
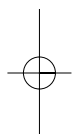



**We were thinking of you**  
when we made this product



### **Welcome to the world of Electrolux**

Thank you for choosing a first class product from Electrolux, which hopefully will provide you with lots of pleasure in the future. The Electrolux ambition is to offer a wide variety of quality products that make your life more comfortable.

You will find some examples on the cover in this manual. Please take a few minutes to study this manual so that you can take advantage of the benefits of your new machine. We promise that it will provide a superior User Experience delivering Ease-of-Mind. Good luck!

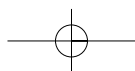
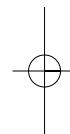
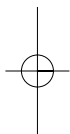

4 electrolux **contents**

## Contents

Safety .....	5
Disposal.....	7
Environmental tips .....	8
Appliance description .....	9
Control panel.....	10-11
Prior to using for the first time ....	12-13
Sorting and preparing laundry.....	12
Starting up for the first time .....	13
Iron Aid™ - Steam-System .....	14-15
Overview of Iron Aid™ programmes .	16
Starting an Iron Aid™ programme ....	21
Overview of drying programmes .....	23
Starting a drying programme .....	27
Cleaning and maintenance .....	28-29
What to do if.....	36
Technical data .....	38

Consumption values.....	38
Installation safety instructions .....	39
Removing transport safety equipment .....	40
Electrical connection.....	40
Special accessories.....	41
Service .....	42
Electrolux Warranty.....	43

The following symbols are used in this user manual:



Important information concerning your personal safety and information on how to avoid damaging the appliance.



General information and tips



Environmental information.

**Important: Only operate the Iron Aid programmes with distilled water!  
Mains water causes damage to the appliance.**



## Safety

### Prior to using for the first time

- Note the "Installation and connection instructions".
- **Important:** The appliance must be moved in vertical position for transport.
- Before first starting up, check the machine for any damage incurred during transport. Never connect up a damaged machine. If parts are damaged, contact your supplier.

### Correct use in accordance with the requirements

- The appliance is intended for drying and iron aid treatment of standard laundry in domestic applications.
- The machine is not intended for use by people (including children) with limited physical, sensory or mental capabilities, lack of experience or lack of knowledge unless supervised or instructed by someone responsible for their safety when using the machine.
- Conversions or modifications to the machine are not permitted.
- Do not use the drying cycle to dry unwashed laundry.
- Laundry which is stained or soaked in oil must not be dried or smoothed in this machine. Risk of fire!
- Before being dried or smoothed, laundry which has come into contact with substances such as oil, acetone, alcohol, petrol, kerosene, stain removers, turpentine, wax or wax removers must be rinsed thoroughly by hand using warm water mixed with a cleaning agent.
- Do not place items of laundry in the machine if they contain foam rubber (Latex foam) or materials similar to rubber. Such items include shower caps, water-repellent textiles, textiles with rubber inserts and pieces of clothing or cushions with foam rubber stuffing.
- Fabric softeners or similar products should not be used in a tumble dryer to eliminate the effects of static electricity, unless this practice is specifically recommended by the manufacturer of the fabric softener or product.
- Do not place heavily worn laundry items in the appliance. Risk of fire!
- Do not place laundry items with loose fillings (e.g. cushions) in the appliance. Risk of fire!
- Parts with rigid components (e.g. door mats) may cover the air slots. Risk of fire! Do not place such items in the appliance.
- Do not overfill the appliance. Risk of fire! Observe max. loading volume of 6 kg.
- To minimize the risk of fire in a tumble dryer, the following should be observed:
  - Items that have been spotted or soaked with vegetable or cooking oil constitute a fire hazard and should not be placed in a tumble dryer.
- Oil-affected items can ignite spontaneously, especially when exposed to heat sources such as in a tumble dryer. The items become warm, causing an oxidation reaction in the oil. Oxidation creates heat. If the heat cannot escape, the items can become hot enough to catch fire. Piling, stacking or storing oil-affected items can prevent heat from escaping and so create a fire hazard.
- If it is unavoidable that fabrics that contain vegetable or cooking oil or have been contaminated by hair care products be placed in a tumble dryer they should first be washed in hot water with extra detergent - this will reduce, but not eliminate, the hazard.

The 'cool down' cycle of tumble dryers should be used to reduce the temperature of the items. They should not be

## 6 electrolux safety

removed from the tumble dryer or piled or stacked while hot.

- Items that have been previously cleaned in, washed in, soaked in or spotted with petrol/gasoline, drycleaning solvents or other flammable or explosive substances should not be placed in a tumble dryer.
- Highly flammable substances commonly used in domestic environments include acetone, denatured alcohol, petrol /gasoline, kerosene, spot removers (some brands), turpentine, waxes and wax removers.
- Items containing foam rubber (also known as latex foam) or similarly textured rubber like materials should not be dried in a tumble dryer on a heat setting.
- Foam rubber materials can, when heated, produce fire by spontaneous combustion.
- Undergarments that contain metal reinforcements should not be placed in a tumble dryer. Damage to the tumble dryer can result if metal reinforcements come loose during drying. When available a drying rack could be used for such items.
- Plastic articles such as shower caps or babies' waterproof napkin covers should not be placed in a tumble dryer.
- Rubber-backed articles, clothes fitted with foam rubber pads, pillows, galoshes and rubber-coated tennis shoes should not be placed in a tumble dryer.
- Explosive objects (e.g. cigarette lighters, spray cans, etc.) must not enter the machine with the laundry. Risk of fire and /or explosion!
- When using dry-cleaning sets: Only use those products which are declared as suitable for the dryer by the manufacturer.
- Clean the micro-fine filter and fine strainer after each drying cycle or Iron Aid programme.
- Do not use the machine without a lint filter or with a damaged lint filter. Risk of fire!
- Only fill the water reservoir with distilled water. Do not use tap water or any additives! The condensed water from this appliance's condensed water container can also be used, if it is filtered first (e.g. with a coffee filter).

- Clean the heat exchanger regularly.
- With stacked washer and Iron Aid appliance: Do not place objects on the appliance. These may fall off during operation.
- The lampcover for the interior light must be screwed down tightly.

### Child safety

- Keep packaging away from children. There is a risk of suffocation!
- Children often do not recognise the hazards associated with electrical appliances. Children should be supervised to ensure that they do not play with the appliance.
- Make sure that children and small animals cannot climb into the appliance's drum. Could endanger life! Keep the appliance door shut whenever it is not being used.
- When discarding the appliance, cut the electrical supply cable and destroy the plug with the remaining cable. Disable to door catch in order to prevent young children from becoming trapped inside the machine while playing.

### General safety

- Under no circumstances should you attempt to repair the machine yourself. Repairs carried out by inexperienced persons may cause injury or serious malfunctioning. Contact your **local Electrolux Customer Service on 131349**. Always insist on genuine spare parts.
- Never start up the appliance if the mains cable is damaged or if the operating screen, operating plate or base area are damaged so that the inside of the machine is open and accessible.
- Should the appliance power supply cable need to be replaced, this must be carried out by our Service Centre.
- Switch off the machine before all cleaning, care or maintenance work. Also disconnect the mains plug from the socket or – with permanent connections – switch off the circuit breaker in the fuse box and/or fully unscrew the screwed-in fuse.
- Disconnect the machine from the power supply during long pauses in operations.
- When removing from the socket, never pull



the mains plug by the cable, instead take a hold of the plug.

- The height adjustable screw feet must never be removed.
- Manifold plugs, couplings and extension cables must not be used. Risk of fire from overheating!
- Do not spray down the appliance with jets of water. Risk of electric shock!
- Do not lean on the open door. The appliance may tip over.
- Once the drying cycle or Iron Aid programme has been interrupted, the laundry and drum may be hot. Risk of burns! Take care when removing the laundry.
- Take care when interrupting the Iron Aid programme: Do not open the machine door during the steam phase. Hot steam

may result in burns. The display has a steam symbol to indicate the steam phase.

- Never stop the appliance before the end of the drying cycle unless all items are quickly removed and spread out so that the heat is dissipated.
- The final part of a drying cycle occurs without heat (cool down cycle) to ensure that the items are left at a temperature that ensures that the items will not be damaged.
-  Caution – Hot surface: Do not touch the back of the appliance while it is operating.

## Disposal



### Packaging material

The packaging materials are environmentally friendly and can be recycled. The plastic components are identified by markings, e.g. >PE<, >PS<, etc. Please dispose of the packaging materials in the appropriate container at your local waste disposal facilities.



### Old appliance

This product  should not be treated as general household waste. Instead it shall be handed over to the applicable collection point for the recycling of electrical and electronic equipment.

By ensuring this product is disposed of





**Warning!** When your appliance has finished its working life, remove the plug from the mains socket. Cut off the cable and plug and dispose of them.

Destroy the door lock. This prevents children from trapping themselves inside and endangering their lives.

correctly, you will help prevent potential negative consequences for the environment and human health, which could otherwise be caused by inappropriate waste handling of this product. For more detailed information about recycling of this product, please contact your local city office, your household waste disposal service or the shop where you purchased the product.

## 8 electrolux **environmental tips**

### Environmental tips

- In the drying cycle the laundry becomes fluffy and soft. Fabric softeners are not therefore needed when washing.
- Filtered condensed water can be used for Iron Aid programmes.
- The appliance works most economically in the drying programmes if you:
  - spin the laundry well before drying.  
Example: Consumption values – depending on spin speed – for 6kg of laundry, dried using the programme  COTTON  CUPBOARD.

Revolutions per minute	Pre-draining		Drying cycle Energy in kWh
	Residual dampness in litres	as a %	
800	4.2	70	4.0
1000	3.6	60	3.7
1200	3.2	53	3.3
1400	3.0	50	3.1
1800	2.5	42	2.6

- always keep the ventilation holes in the dryer plinth unobstructed;
- use the loads specified in the programme overview;
- ensure you have good ventilation in the room;
- clean micro filter and fine filter after every drying or Iron Aid programme:



## Appliance description

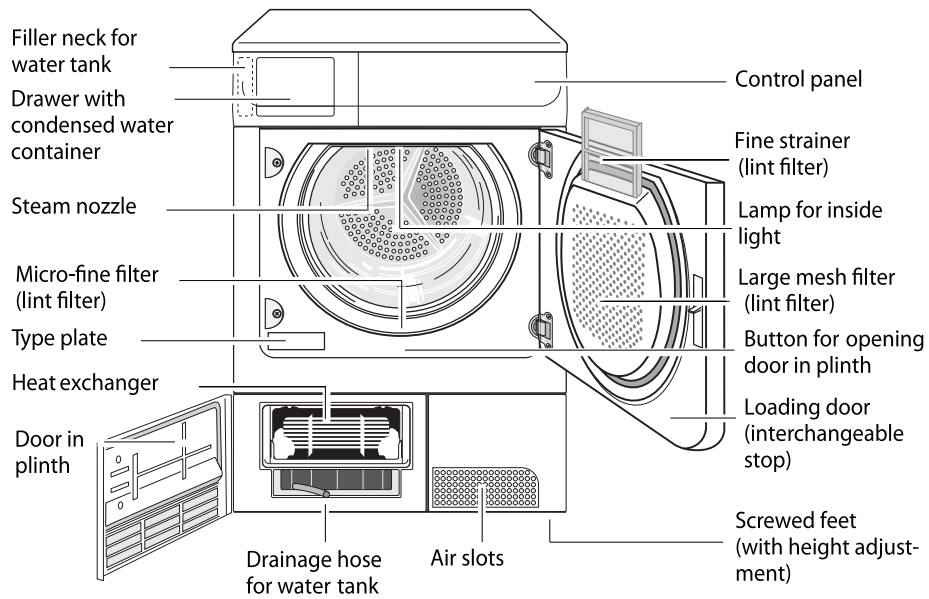

10 electrolux control panel

Control panel

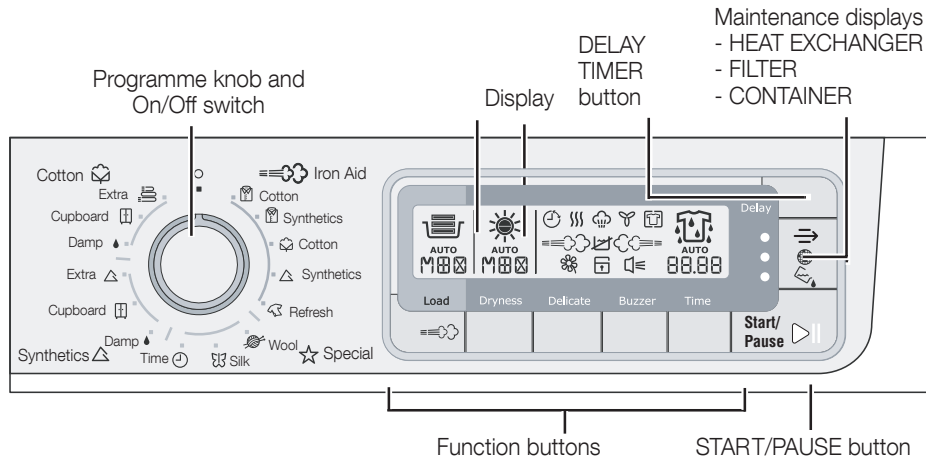

What is shown in the display

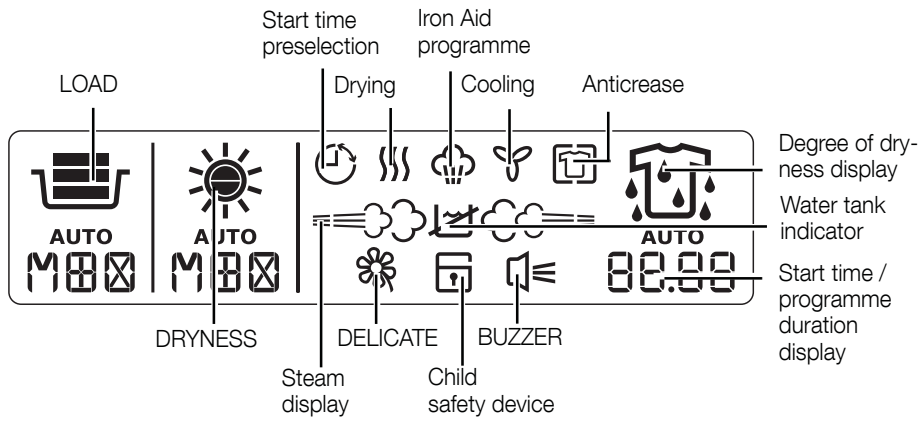

## Function overview: Iron Aid™ Steam System

This appliance can be used both as a dryer and to condition clothes (Iron Aid) to treat garments using steam.

When it is operating as a dryer, there are 9 available programmes.

When it is operating as a steam appliance, there are 4 available programmes for smoothing and removing odours from wet and dry laundry and the REFRESH

programme for smoothing and removing odours from dry outerwear. Garments are softened and smoothed and require a lot less ironing.

If laundry is wet, a drying programme is automatically activated before the Iron Aid programme starts.

**Exception:** The REFRESH programme must only be used for dry laundry.

Laundry type	Programmes	Laundry type	Iron Aid washed garments	Smooths worn clothing	Odour removal worn clothing
DRYING	Cotton EXTRA	wet			
	Cotton CUPBOARD	wet			
	Cotton DAMP	wet			
	Synthetics EXTRA	wet			
	Synthetics CUPBOARD	wet			
	Synthetics DAMP	wet			
	WOOL	wet			
	SILK	wet			
	TIME	wet			
IRON AID	COTTON	wet/dry	X	X	X
	SYNTHETICS	wet/dry	X	X	X
	COTTON	wet/dry	X	X	X
	SYNTHETICS	wet/dry	X	X	X
	REFRESH	dry		X	X

**12 electrolux prior to using for the first time**

## Prior to using for the first time

In order to remove any residues which may have been produced during production, wipe the dryer drum with a damp cloth or carry out a brief drying cycle (30 MIN) with damp cloths in the machine.

1. Turn the programme knob to  TIME.
2. Press the TIME button repeatedly until 0.30 appears in the display.
3. Press the START/PAUSE button.





## Sorting and preparing laundry

Sorting laundry – general

- Sorting by fabric type:
  - Cotton/linen for programmes in the  COTTON programme group.

– Mixed fibres and synthetics for programmes in the  SYNTHETICS programme group.



- Sorting by care label. The care labels mean:

			
<b>Drying in the tumble dryer possible in principle</b>	<b>Dry at normal temperature</b>	<b>Dry at reduced temperature (press SPECIAL CARE button!)</b>	<b>Drying in the tumble dryer not possible</b>



**Important: Do not place in the appliance any wet laundry which is not specified on the care label as being suitable for tumble-drying.**

This appliance can be used for all wet laundry items which are labelled as suitable for tumble-drying.

- Do not dry new, coloured textiles together with light-coloured laundry items. Textile colours may bleed.
- Do not dry cotton jersey and knitwear with the  EXTRA programme. Items may shrink!
- Wool and wool-like textiles can be dried using the  WOOL programme. Before the drying cycle spin the woollen textiles as well as

possible (max. 1200 rpm). Only dry woollen textiles together which are similar or the same with respect to material, colour and weight. Please dry heavy laundry items made of wool separately.

### Special notes about Iron Aid



- The following textiles cannot be treated using an Iron Aid programme: woollen knitwear, leather, textiles with large metal, wooden or plastic parts, textiles with rusting metal parts, oilskins or wax cotton garments.



- To smooth or freshen laundry with an Iron Aid programme, sort laundry by size, weight, material and colour. Only smooth textiles together that are similar in terms of size, weight, material and colour.



- Do not dry new, coloured textiles together with light-coloured laundry items. Colours may fade (check colour fastness of fabric when damp in an inconspicuous area).



- Do not use dry cleaning sets such as dryel in combination with Iron Aid programmes.

## starting up for the first time electrolux 13

### Preparing laundry - general

- To avoid laundry becoming tangled: close zips, button up duvet covers and tie loose ties or ribbons (e.g. of aprons).
- Empty pockets. Remove metal items (paper clips, safety pins, etc).
- Turn items with double-layered fabrics inside out (e.g. with cotton-lined anoraks, the cotton layer should be outermost). These fabrics will then dry better.

### Special notes about Iron Aid

- Before treating garments with an Iron Aid programme, remove stains by washing or using localised stain removal.

### Starting up for the first time

#### Switching machine on / switching light on

Turn the programme knob to any programme. The machine has been switched on. When the loading door is opened, the drum is illuminated.

#### Opening loading door / loading laundry

1. Open loading door:  
Push against the loading door (push point)
2. Load your laundry (do not force it in/ overload the machine).



**Caution! Be careful not to trap laundry in between the loading door and rubber seal.**

3. Close loading door securely. Lock must audibly lock.

## 14 electrolux iron aid™ - steam-system

### Iron Aid™ Steam System

#### Fill water tank

You must fill up the water tank before using an Iron Aid programme for the first time. Use the distilled water provided if there is not yet any condensed water from previous drying programmes (see chapter on 'Cleaning and Maintenance, Emptying condensed water container').

If, after an Iron Aid programme is selected, the water tank indicator on the display lights up, you will need to fill up the  water tank with distilled water. Otherwise, you will not be able to start any Iron Aid programme.



**Important Only fill the water tank with distilled or fully desalinated water. Do not use tap water or additives! You can also use the condensed water from the condensed water container, as long as you filter it first (use the canister supplied with the filter fitted: see figure opposite).**

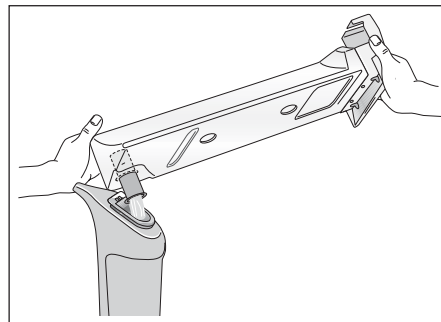

1. Pull drawer containing condensed water container out a little (1), then pull out the water tank's filler neck (2).

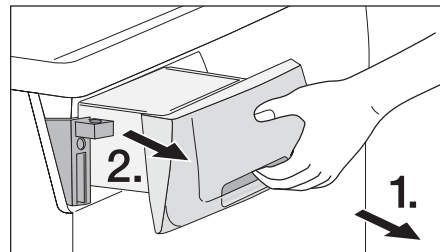

**iron aid™ - steam-system** electrolux 15

2. Fill with distilled water from the canister provided, up to the MAX mark inside the container.
3. Push filler neck and drawer with condensed water container back in.

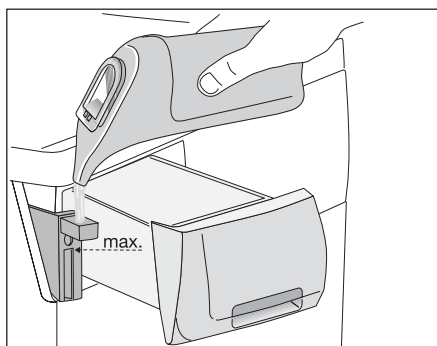





**When dry, all textiles not specifically prohibited in the chapter 'Sorting and preparing laundry' may be treated with the Iron Aid Steam System. Wet textiles may only be treated if they are labelled as suitable for dry programmes.**



## 16 electrolux overview of iron aid™ programmes

## Overview of Iron Aid™ programmes

Programmes	Max. load * (Weight when dry)	Additional functions		Application/properties	
		LOAD	BUZZER		
 COTTON	1,0kg	•	•	For 1- 5 cotton shirts. Min. 80% natural fibres (cotton, linen etc).	<b>wet, dry</b>
 SYNTHETICS	1.0kg	•	•	For 1- 5 synthetic shirts. Max. 20% natural fibres (cotton, linen etc).	<b>wet, dry</b>
 COTTON	3,0kg	•	•	For smoothing cotton garments. Min.80% natural fibres (cotton, linen etc).	<b>wet, dry</b>
 SYNTHETICS	1.5kg	•	•	For smoothing easy-care garments. Max. 20% natural fibres (cotton, linen etc).	<b>wet, dry</b>
 REFRESH		•	•	For one suit or up to two suit jackets or pairs of trousers or similar garments. Also suitable for removing odours. For dry garments only	<b>dry</b>







All information on applications is for guidance only. Smoothing results may vary depending on the selected programme and especially the fittings and material properties of the textile. The results can be improved if necessary by using different programmes and steam volumes. For example, some textiles containing more than 20% synthetics but with the right fittings may behave more like cotton textiles in an Iron Aid programme. You may therefore get better smoothing results by selecting a cotton Iron Aid programme.



Given the wide range of different textile grades and properties that can be manufactured today using different mechanical and chemical processes, we recommend running the first few Iron Aid programmes at low steam levels and with a small number of garments that are as similar as possible. Later, you can carefully start to vary the conditions of Iron Aid programmes to learn from experience how to get the best results from the volume of laundry loaded, the quality of the textiles and the most suitable steam levels and Iron Aid programmes. Please also note the accompanying 'Textile Guide'.

## overview of iron aid™ programmes electrolux 17

Programme	LOAD	Loading volume	DURATION dry* [min.]	DURATION wet* [min.]
 COTTON	MIN MED MAX	1 - 2 items 3 - 4 items 5 items	19 +/-3	+40 +/- 10
 SYNTHETICS	MIN MED MAX	1 - 2 items 3 - 4 items 5 items	21 +/-3	+30 +/- 10
 COTTON	MIN MED MAX	0.5 - 1 kg 1 - 2 kg 2 - 3 kg	20 +/-3	+40 +/- 10
 SYNTHETICS	MIN MED MAX	0,2 - 0,5 kg 0.5 - 1 kg 1 - 1.5 kg	21 +/-3	+30 +/- 10
 REFRESH	MIN MED MAX	1 pair of trousers 1 jacket 1 suit	19 +/-3	



**All information provided on selecting the steam level and corresponding load are suggestions only. In some cases, using a higher steam level or smaller load may give better results. The  REFRESH programme is a gentle Iron Aid programme for nonwashable textiles. Any distortion to the shape of a garment which might occur in few cases, can be remedied by ironing.**

\* exact programme times appear in the display once the machine has performed wet/dry recognition (approx. 2 min.)

## 18 electrolux overview of iron aid™ programmes

### Selecting the programme

Use the programme selector to set the programme you require. The estimated programme duration (in minutes) appears in the multidisplay.

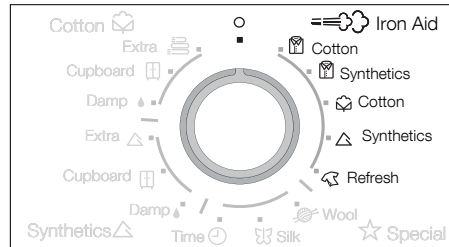

### Select steam level (LOAD)

**To achieve the best results, different steam levels are required for different volumes of laundry. The LOAD button is used to set the required steam level: MIN, MED or MAX.**

All Iron Aid programmes, apart from the REFRESH programme, automatically recognise the remaining dampness in clothes. When laundry is wet, a drying cycle is activated first if required.

The table shows the steam levels appropriate for the selected load, under LOAD.

1. Press the LOAD button repeatedly until the desired steam level (MIN, MED or MAX) is shown in the display.

If the LOAD button is not pressed after an Iron Aid programme is selected, the medium steam level (MED) is selected automatically.

If you select the REFRESH programme, MIN is selected automatically.

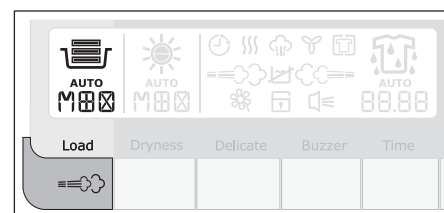
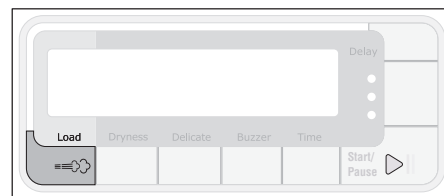

## overview of iron aid™ programmes electrolux 19



**Important: If in doubt, always select a lower steam level first until you have more experience with load volumes, fabric types and the corresponding optimum steam level.**

**If too high a steam level is selected, garments may lose their shape. If too low a steam level is selected, creases may remain.**

### Selecting additional functions

The additional functions available for the Iron Aid programmes are BUZZER, TIME, DELAY and the CHILD LOCK.



### BUZZER

The appliance is supplied with the BUZZER function activated. When the drying cycle has finished, an intermittent acoustic signal will sound. Each time a button is pressed or a programme is changed using the programme knob, an audible signal is also set to sound.

The button is used to switch the function on or off. When the function is active, the  BUZZER symbol appears in the display.

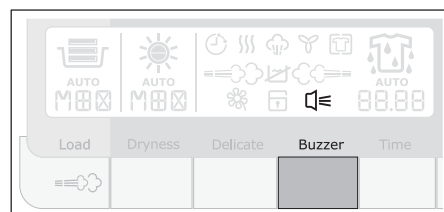

## 20 electrolux overview of iron aid™ programmes

### Delay timer



With the DELAY button, you can delay the start of a programme by between 30 minutes (30') and a maximum of 20 hours (20h).

1. Select the programme and additional functions.
2. Press the DELAY button as many times as necessary until the required start delay appears on the display, e.g. 12h if the programme is to be started in 12 hours.



If the display is showing 20h and you press the button again, the time delay will be cancelled. The display will show 0' and then the duration of the selected programme.

3. To activate the delay timer, press the START/PAUSE button. The amount of time remaining until the programme is set to start is continuously displayed (e.g. 15h, 14h, 13h, ... 30' etc).

### Child safety device

The child lock can be set to prevent a programme being accidentally started or a programme in operation being accidentally changed.

The child safety device locks all buttons and the programme knob. The child safety device can be activated or deactivated by holding down the BUZZER and TIME buttons simultaneously for 5 seconds.

- Before programme is started:  
Appliance cannot be used
- After programme is started:  
Programme in operation cannot be changed

The  symbol appears in the display to indicate that the child safety device is activated.

The child safety device is not deactivated once the programme comes to an end.

If you want to set a new programme, you must first deactivate the child safety device.

## Starting an Iron Aid™ programme

Press the START/PAUSE button. The programme is started.

First, the drying phase indicator appears in the display.

The display will also show the programme duration for the selected Iron Aid programme, not including the additional drying phase.

With wet laundry, after a few minutes the appliance will show the correct programme duration for the Iron Aid programme including the preceding drying programme.

As soon as the right level of dryness is reached, the Iron Aid programme will start automatically. The steam indicator shows the progress of the Iron Aid programme in the display. The individual steam phases are shown by  animated clouds of steam.



**Important:** During the steam phases that form part of the Iron Aid programme and also the anti-crease phase (represented by animated clouds of steam in the display), the loading door cannot be opened.  
**Risk of burns!**

If the  water tank indicator lights up when you select an Iron Aid programme, the programme cannot be started. You will need to fill the water tank first (see section on 'Cleaning and maintenance, filling water tank'.)

## starting an iron aid™ programme electrolux 21



It is normal for the appliance to make noises during an Iron Aid or drying programme if garments with hard parts, such as metal buttons, are put in the drum.

### Changing a programme

To change a programme which has been selected by mistake once the programme has started, first turn the programme selector to O OFF and then reset the programme.



The programme can no longer be changed directly once the programme has started. If you nevertheless attempt to change the programme with the programme knob or an additional function button (except the BUZZER button), the START/PAUSE button and **ERR** will flash in the display. The drying programme is not however affected by this.

Putting in extra items or taking items out before end of programme

1. Open door.





**Warning! Laundry and drum can become hot. Risk of burns!**

2. Load or remove laundry items.
3. Close door securely.
4. Press the START/PAUSE button to continue the drying cycle.

## 22 electrolux starting an iron aid™ programme

### Iron Aid™ programme complete / removing laundry

After the Iron Aid phase has ended, 0.00 is illuminated and the message  ANTICREASE appears in the display. If the  BUZZER has been activated, an audible signal sounds at regular intervals.



The Iron Aid programme is automatically followed by an anti-crease phase, including brief steam phases, which lasts around 90 minutes.

The drum rotates during the anti-crease phase. This keeps the laundry loose and free of creases. It can be removed at any point during the anti-crease phase, except during steam phases (look for steam animation in the display!). Laundry should be removed as quickly as possible.

1. Open the loading door to remove the laundry.
2. Before removing the laundry, remove fluff from the micro-fine filter. It is best to use a damp hand for this purpose. (See "Cleaning and maintenance" section.)
3. Remove laundry one garment at a time.





























To retain the effects of the Iron Aid treatment, clothes must be removed one garment at a time during the anti-crease phase and hung immediately on a clothes hanger to dry (for at least 5-15 mins, depending on fabric and selected steam level). **Do up the buttons and tug the garment into shape, paying particular attention to cuffs and seams.**

4. Turn the programme knob to  OFF. **Important!** After each drying cycle
  - Clean the micro-fine filter and fine filter
  - Drain the condensed water container (See section "Cleaning and maintenance".)
5. Close door.



## Overview of drying programmes

Programmes		Max. load (Weight when dry)	Additional functions			Application/properties	Care symbols
			BUZZER	DELICATE	DRYNESS		
COTTON	 EXTRA 6 kg	•	•	•	Thorough drying of thick or multilayered fabrics, e.g. terry towelling items, bathrobes.	 	
	 CUPBOARD* 6 kg	•	•	•	Thorough drying of fabrics of even thicknesses, e.g. terry towelling items, knitwear, towels.	 	
	 DAMP 6 kg	•	•	•	For normal thickness cotton or linen laundry, e.g. bedding, table linen.	 	
SYNTHETICS	 EXTRA 3 kg	•	•	•	Thorough drying of thick or multilayered fabrics, e.g. pullovers, bedding, table linen.	  <sup>1)</sup> 	
	 CUPBOARD 3 kg	•	•	•	For thin fabrics which are not ironed, e.g. easy care shirts, table linen, baby clothes, socks, lingerie with bones or wires.	  <sup>1)</sup> 	
	 DAMP 3 kg	•	•	•	For thin textiles which are still to be ironed, e.g. knitted items, shirts.	  <sup>1)</sup> 	
	 TIME 1 kg	•	•	AUTO	For further drying of individual items of laundry or for small volumes of less than 1kg. You can select a programme duration from 10 mins to 3 hrs in 10-minute steps.	  <sup>1)</sup> 	
SPECIAL	 SILK 1 kg	•	AUTO	•	Special programme for drying silk using warm air and gentle movement.		
	 WOOL 6 kg	•	AUTO	•	Special programme, for drying woollen fabrics with minimum physical stress. "Sorting and preparing washing".) Recommendation: Remove fabrics immediately after drying, as no anti-crease programme follows.		

1) Press the DELICATE button.

\*) Cotton cupboard with max dryness is the reference program for energy rating label, according to AS/NZS 2442.2

## 24 electrolux overview of drying programmes

### Selecting the programme

Use the programme selector to set the programme you require.  
The probable programme run time is displayed (in minutes) on the multidisplay.

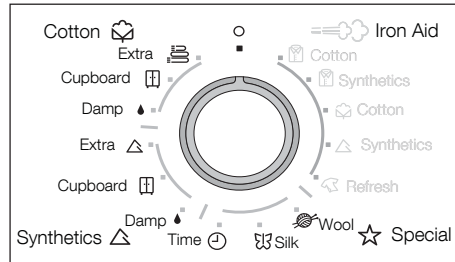

### Selecting additional functions



You can choose from the additional functions DRYNESS, DELICATE, BUZZER and TIME (if a ⌚ TIME programme has been selected). The symbols of the functions available for the selected programme are shown in the display.



### DRYNESS

If laundry comes out of the machine too damp after a standard drying programme, you can increase the drying result by using the DRYNESS function. Laundry becomes drier as you move from MIN to MAX.

1. Press the DRYNESS button repeatedly until the desired dryness level (MIN, MED or MAX) is shown in the display. If another programme has been selected, AUTO flashes in the display.

If wool or silk comes out of the machine too damp at the end of a  WOOL or  SILK programme, you can dry it again by restarting the appropriate programme, this time with the DRYNESS function selected and dryness level MIN, MED or MAX. In the case of a drying cycle with relatively dry laundry, the length of the programme cycle displayed at the beginning is corrected after a while.

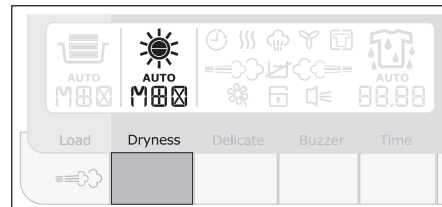

## overview of drying programmes electrolux 25



**Caution:** Make sure that by selecting the DRYNESS function, you do not over-dry your wool or silk.

### DELICATE

For especially gentle drying of sensitive fabrics with the care label and for temperature-sensitive textiles (e.g. acrylic, viscose). Programme is executed with reduced heat. DELICATE is only suitable for use with loads of up to 3kg.

1. Press the DELICATE button. The DELICATE symbol appears in the display.

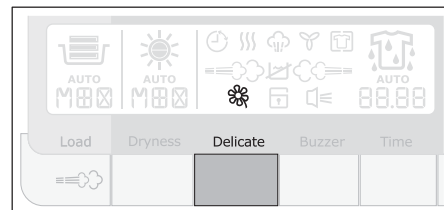

### BUZZER

The appliance is supplied with the BUZZER function activated. When the drying cycle has finished, an intermittent acoustic signal will sound. Each time a button is pressed or a programme is changed using the programme knob, an audible signal is also set to sound.

The button is used to switch the function on or off. When the function is active, the BUZZER symbol appears in the display.

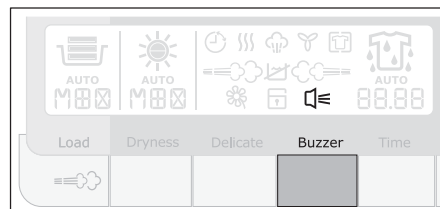

## 26 electrolux overview of drying programmes

### TIME ⌚

To select the programme duration after setting the ⌚ TIME programme. You can select a programme duration from 10 mins to 3 hrs in 10-minute steps.

1. Turn the programme knob to the ⌚ TIME programme. The display will show 0.10 (corresponding to the 🌀 COOLING programme).
2. Press the TIME button repeatedly until the desired programme duration is shown in the display, e.g. 00.20 for a programme of 20 minutes.

If the programme duration is not selected, the duration is automatically set to 10 mins.

To set the timer delay and the child safety device, please refer to the chapter on 'Iron Aid, setting the timer delay' / 'Setting the child safety device'.

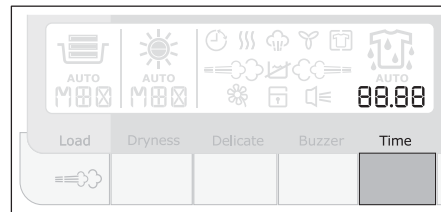

## Starting a drying programme

Press the START/PAUSE button. The programme is started.

The programme progress display shows drying progress. The symbols for ☰ DRYING and ☹ COOLING appear in the display one after the other. The number of droplets in the dryness indicator gradually goes down as the drying process progresses.

## Changing a programme

To change a programme which has been selected by mistake once the programme has started, first turn the programme selector to O OFF and then reset the programme.



The programme can no longer be changed directly once the programme has started. If you nevertheless attempt to change the programme with the programme knob or an additional function button (except the BUZZER button), the START/PAUSE button and Err will flash in the display. The drying programme is not however affected by this.

Putting in extra items or taking items out before end of programme

1. Open door.



**Warning! Laundry and drum can become hot. Risk of burns!**

2. Load or remove laundry items.

3. Close the door securely. Lock must audibly lock.
4. Press the START/PAUSE button to continue the drying cycle.

## Drying cycle complete / removing laundry

Once the drying programme has finished, CREASE GUARD lights up in the display. If the BUZZER is activated, an audible signal sounds at regular intervals.



**The drying cycle is automatically followed by a anti-crease phase which lasts around 30 minutes.**

The drum rotates at intervals during this phase. This keeps the laundry loose and free of creases. It can be removed at any time during the anti-crease phase. (The laundry should be taken out towards the end of the anti-crease phase at the latest to prevent creases from forming.)

1. Open door.
2. Before removing the laundry, remove fluff from the micro-fine filter. It is best to use a damp hand for this purpose. (See "Cleaning and maintenance" section.)
3. Remove laundry.
5. Turn the programme knob to O OFF. Important! After each drying cycle
  - Clean the micro-fine filter and fine filter
  - Drain the condensed water container (See section "Cleaning and maintenance".)
6. Close door.

## 28 electrolux **cleaning and maintenance**

### Cleaning and maintenance

#### Cleaning lint filters

To ensure that the appliance works perfectly, the lint filters in the door and in front of the drum must be cleaned after every Iron Aid or drying cycle.



**Important Never operate the dryer without the lint filter or with a damaged or blocked lint filter.**

1. Open the door.
2. Use a damp hand to clean the lint filter, which is built into the lower part of the loading aperture.

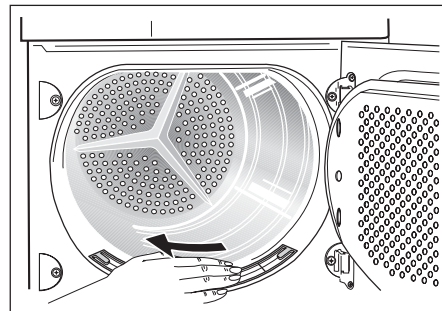

3. Remove the lint filter from the door by pulling the grip upwards.
4. Remove fluff from lint filter, preferably using a damp hand for this purpose.
5. Replace the filter.

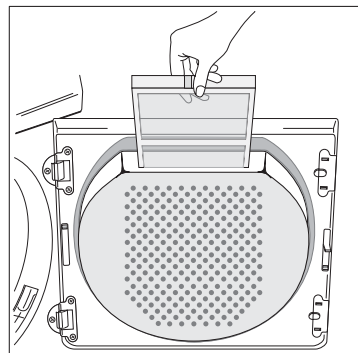

### Cleaning the filter area



The filter area does not have to be cleaned after every drying cycle, but should be checked regularly and cleaned of fluff, if necessary.

You will need to undertake the following to clean the filter area:

1. Remove lint filter (see chapter on 'Cleaning lint filters').
2. Remove fluff from the entire filter area. It is best to use a vacuum cleaner for this purpose.
3. Replace the filter.

### Clean the door seal.

Wipe the door seal using a damp cloth immediately after the Iron Aid or drying cycle.



### 30 electrolux **cleaning and maintenance**

#### Emptying the condensed water container

Empty condensed water container after every drying cycle.

If the condensed water container is full, an active programme will break off automatically and the TANK display will light up. In order to continue the programme, the condensed water container must first be emptied.



**Warning! The condensate is not suitable for drinking or for preparing foodstuffs.**

1. Pull drawer containing condensed water container all the way out (1) and pull up the condensed water container's drainage pipe as far as it will go (2).

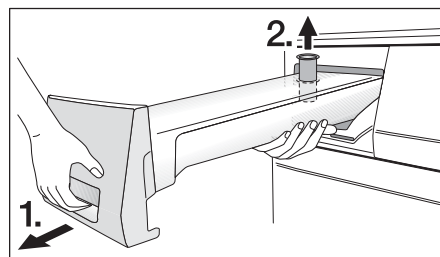

2. Pour out the condensate into a basin or similar container.
  3. Push drainage pipe in and refit condensed water container.
- If the programme has been interrupted as a result of the condensed water container being full:  
Press the START/PAUSE button to continue the drying cycle.

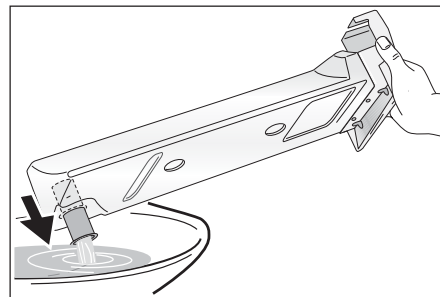

The condensed water container has a volume of approx. 4 litres. This is sufficient for around 6 kg of laundry which has previously been spun at 1000 revolutions/minute.

4. The condensed water be used as distilled water, e.g. for steam irons. However, first filter the condensed water to remove any residues and small pieces of fluff.

Using the attached canister to filter: Pour the water out of the container straight through the filter at the top of the canister.

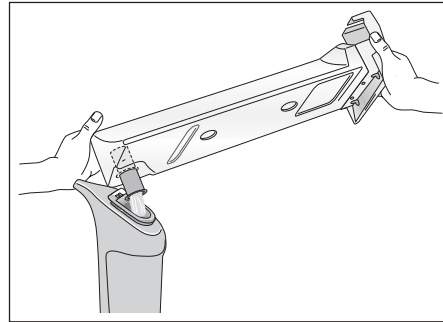

### Fill water tank

You must fill up the water tank before using an Iron Aid programme for the first time. Use the distilled water provided if there is not yet any condensed water from previous drying programmes (see chapter on 'Cleaning and Maintenance, Emptying condensed water container'). If, after an Iron Aid programme is selected, the water tank indicator on the display lights up, you will need to fill up the  water tank with distilled water. Otherwise, you will not be able to start an Iron Aid programme.



**Important** Only fill the water tank with distilled or fully desalinated water. Do not use tap water or additives! You can also use the condensed water from the appliance's container, as long as you filter it first.

1. Pull drawer containing condensed water container out a little (1), then pull out the water tank's filler neck (2).

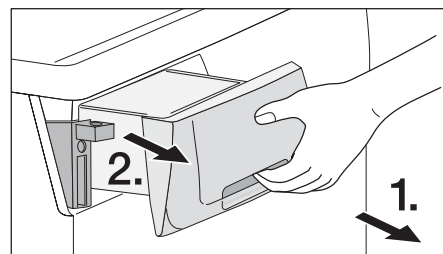

### 32 electrolux **cleaning and maintenance**

2. Fill with distilled water from the canister provided, up to the MAX mark inside the container.
3. Push filler neck and drawer with condensed water container back in.



The water tank has a volume of approx. 1.3 litres. This is sufficient for around 4 – 10 Iron Aid programmes with garment steaming, depending on the selected volume of steam, programme and the corresponding steam phases during the crease guard phase.

You can easily check the level of water in the tank at any time by looking at the fill indicator in the viewing window. The maximum fill level is indicated by the MAX mark.

An overflow guard prevents the container from being overfilled.

The water tank indicator on the display lights up as soon as the fill volume in the tank falls below 500 ml when you start a programme (this corresponds to the maximum volume of water required for the Iron Aid programme that uses the most steam, including the crease guard phase). This prevents an Iron Aid programme from being interrupted because of an empty water tank.

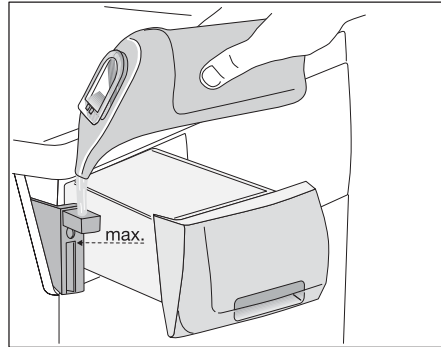

### Emptying the water tank for long periods of disuse

If Iron Aid programmes are not run for more than three weeks, the tank should be emptied and refilled with fresh distilled water if required.

1. Open door in plinth in front of heat exchanger (see chapter on 'Cleaning the heat exchanger') and place a collecting container in front of the appliance.
2. Pull out the drainage hose underneath the heat exchanger (1).
3. Remove the plug from the end of the hose (2) and allow the water to drain into the collecting container.
4. Then seal the hose again and push it back into its original position.
5. Close door in plinth.

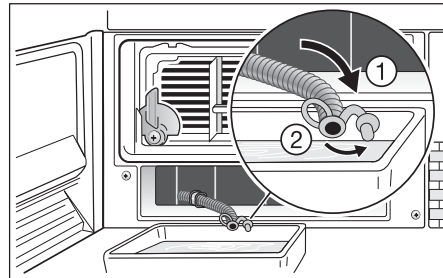

### 34 electrolux **cleaning and maintenance**

#### Cleaning heat exchanger

If the HEAT EXCHANGER display is illuminated, the heat exchanger needs to be cleaned.



**Caution!** Operating when the heat exchanger is clogged with lint can damage the appliance. This also increases energy consumption.

1. Open loading door
2. Open base door. To do this, press the release button located beneath the loading aperture and open the base door to the left.
3. Remove lint from the inside of the door and the heat exchange chamber. Wipe the door seal with a damp cloth.

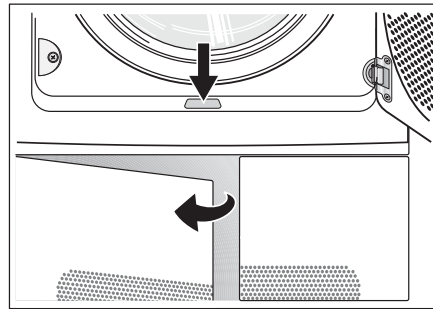

4. Turn both lock washers inwards.

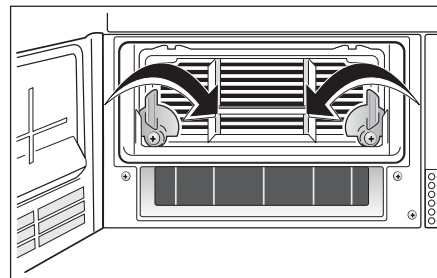

5. Use the handle to pull the heat exchanger out of the base and carry it horizontally to prevent any remaining water from spilling.
6. To empty the heat exchanger, hold vertically over a washing-up bowl.

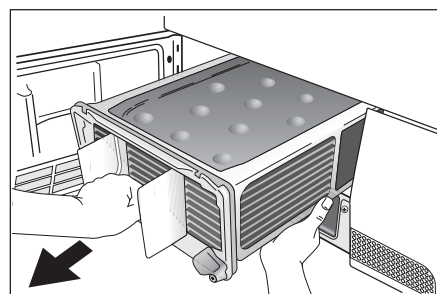



**Caution!** Do not use sharp objects to clean the heat exchanger. You could damage it and cause leaks.

7. To clean the heat exchanger, it is best to use a brush to dislodge build-up, then rinse thoroughly under a shower head.
8. Replace heat exchanger and lock into place (turn both lock washers outwards until they snap into place).
9. Close base door.



The appliance will not operate if the HEAT EXCHANGER indicator is still lit.



**Caution!** Never operate the appliance without the heat exchanger.

## Cleaning the drum



**Important!** Do not use scourers or steel wool to clean the drum.



Lime in the water or laundry care products may form a barely visible lining on the inside of the drum. The degree to which the laundry has been dried is then no longer detected reliably. The laundry is damper than expected when removed from the appliance.

Use a standard domestic cleaner (e.g. vinegar-based cleaner) to wipe down the inside of the drum and drum ribs.

## Clean control panel and housing



**Important!** Do not use furniture cleaners or aggressive cleaning agents to clean the appliance.

Use a damp cloth to wipe down the control panel and housing.



## Changing the light bulb for interior lighting



**Important:** The bulb for the interior lighting must be changed by our Customer Care Department.

**36** electrolux **what to do if...****What to do if...****Remedying small malfunctions**

If, during operation, the error code (E plus number or letter) appears on the multi-display: Switch the appliance off and on again. Reset programme. Press the START/PAUSE button.

If the error appears again, please contact the Customer Care Department, stating the error code.

Problem	Possible cause	Remedy
Washing machine does not work.	Mains plug is not plugged in or fuse is not working correctly.	Plug in at mains socket. Check fuse in fuse box (domestic installation).
	Door is open.	Close door.
	Press the START/PAUSE button.	Press the START/PAUSE button.
Drum light is not working.	Programme selector in O OFF position.	Turn the programme selector to any programme.
	Defective light bulb.	Replace light bulb (see next section).
Iron Aid programme does not start.	Water tank is empty.	Fill water tank.
After an Iron Aid programme, garments are not sufficiently smooth.	Wrong programme selected (e.g.  SYNTHETICS instead of  COTTON).	Note the composition of the fabric.
	Too low a LOAD steam level set.	Set a higher LOAD steam level.
	Too many garments in machine, or garments that are too different.	Load the machine with fewer garments, or only similar ones.
	Clothes are not removed until the anti-crease phase is finished.	Remove clothes quickly one at a time from the machine as soon as possible after the start of the anticrease phase.
	Garments not hung on clothes hangers and/or not tugged into shape.	Hang garments on clothes hangers, do up buttons and tug garments into shape.
Multi-layered garments tend to lose their shape.	Reshape multi-layered garments by ironing after they come out of the machine..	
After an Iron Aid programme, there are no creases left in the garments.	The Iron Aid programme has the effect of smoothing garments.	Iron creases in again after the Iron Aid programme.

Problem	Possible cause	Remedy
Drying results unsatisfactory.	Wrong programme selected.	Select a different programme the next time you dry (see section "Overview of programmes").
	Lint filter blocked.	Clean lint filter.
	Heat exchanger blocked with fluff.	Clean heat exchanger.
	Incorrect amount of washing.	Observe recommended loads.
	Ventilation slots in base area covered up.	Uncover ventilation slots in base area.
	Residue on inside surface of drum or drum paddles.	Clean inside surface of drum and drum paddles.  Adjust using the DRYNESS additional function (see chapter on 'Drying, selecting additional functions').
When you press a button Err appears in the multidisplay.	Laundry guard. Additional functions cannot be selected after a programme has started.	Turn the programme knob to O OFF. Reset programme.
Drying cycle ends shortly after programme starts. ANTICRE-ASE display illuminated.	Too little laundry has been loaded for the selected programme, or laundry that is too dry.	Select time programme or higher drying level (e.g.  EXTRA instead of  CUPBOARD).
Programme inactive, TANK display illuminated.	Condensed water container is full.	Empty condensed water container, then start programme with the [START/PAUSE] button.
PROGRAMME TIME display changes erratically or stays unchanged for a long time.	Programme time is corrected automatically depending on type and volume of laundry and level of dampness	Automatic process, there is no fault with the appliance.
Drying cycle lasts an unusually long time. Note: After up to 5 hours the drying cycle ends automatically (see 'End of drying cycle').	Fluff filter blocked.	Clean fluff filter.
	Heat exchanger blocked with fluff.	Clean heat exchanger.
	DELICATE button pressed and load volume too big.	DELICATE is only suitable for use with loads of up to 3kg!
	Load volume too big.	Reduce load volume.
Discoloration	Laundry insufficiently predrained.	Laundry must be adequately predrained.
	Colour fastness of textiles.	Check colour fastness of textiles. Only treat textiles together if they are a similar colour.



**38** electrolux **technical data**

## Technical data



This appliance conforms with the following EU Directives:

- 73/23/EEC dated 19.02.1973 Low Voltage Directive
- 89/336/EEC dated 03.05.1989 EMC Directive inclusive of Amending Directive 92/31/EEC
- 93/68/EEC dated 22.07.1993 CE Marking Directive

Height x width x depth	85 x 60 x 60 cm
Depth with loading door open	109 cm
Height can be adjusted by	1.5 cm
Weight when empty	approx. 46 kg
Load (depends on programme) <sup>1)</sup>	max. 6 kg
Energy consumption in accordance with AS/NZS 2442.2 (6kg cotton load, using ☼ COTTON ☐ CUPBOARD program with max dry option selected) : 264 kWh per year when energy rating program used once per week	3,7 kWh
Area of use	Domestic
permissible ambient temperature	+ 5°C to + 35°C

<sup>1)</sup> Different loading volume data may be needed in some countries as a result of different measuring methods.

## Technical data

The consumption values have been established under standard conditions.

They may deviate when the machine is operated in domestic circumstances

Programme	Load in kg	Energy consumption in kWh
☼ COTTON ☐ CUPBOARD <sup>1)</sup>	6	3,7
☼ COTTON ▾ DAMP <sup>1)*)</sup>	6	3,0
△SYNTHETICS ☐ CUPBOARD <sup>2)</sup>	3	1,4

<sup>1)</sup> pre-drained at 1000 rpm

<sup>2)</sup> pre-drained at 1200 rpm

\*) corresponds to the programme COTTON HAND IRON



## Installation safety instructions

- **Important!** The appliance must be moved in vertical position for transport.
- Before first starting up, all parts of the transport safety equipment must be removed. The machine may otherwise be damaged.
- The appliance must not be built-in.
- Before starting up for the first time, ensure that the nominal voltage and type of current specified on the appliance's rating plate match the nominal voltage and type of current at the installation site. The electrical fuse required can also be found on the rating plate.
- Always connect the machine to an earthed socket in accordance with current wiring regulation. The manufacturer declines any responsibility for damage or injury through failure to comply with the above safety precaution.
- With permanent connections: A permanent connection may only be established by an authorised specialist electrician.
- Do not install appliance in rooms at risk of frost.
- Do not position the appliance behind
  - a door that can be locked,
  - a sliding door
  - a door with a hinge situated opposite the appliance's hinge.
- The door of the appliance must not be able to be blocked by house doors or other appliance doors.
- Do not install on a carpet with a high pile. Air circulation at the ventilation holes will be hindered.
- Ensure that the appliance is not standing on the mains cable. Install the machine horizontally.

#### 40 electrolux removing transport safety equipment

### Removing transport safety equipment



**Caution!** Before use all parts of the transport packaging must be removed.

1. Open loading door
2. Pull off adhesive strips from inside machine on top of drum.

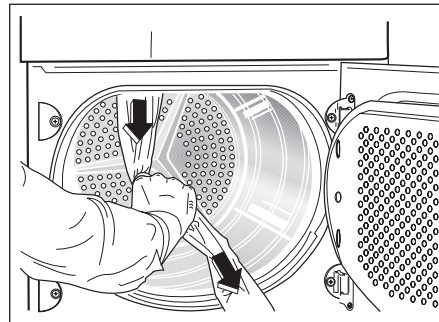

3. Remove foil hose and polystyrene padding from the machine.

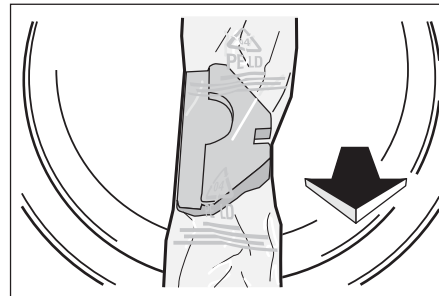

### Electrical connection

Details on mains voltage, type of current and the fuses required should be taken from the type plate. The type plate is fitted near the loading aperture (see "Machine description" section).

**CAUTION:** If the appliance is supplied from a cord extension set or electrical portable outlet device, the cord extension set or electrical portable outlet device must be positioned so that it is not subject to splashing or ingress of moisture.

**Important:**

The plug must be accessible after the appliance has been installed.

## Levelling the appliance

The four feet of the appliance are preadjusted.

Large degrees of unevenness can be compensated for by individually adjusting the height adjustable screw feet.

To do this lift the appliance and turn the adjustable feet in or out.

**Important** Do not use pieces of wood, cardboard or such like to level out unevenness in the floor, but adjust the height adjustable screw feet instead.

## Special accessories

The following special accessories are available from your Electrolux service centre or your specialist dealer:

### **Intermediate installation kits for stacked washer and iron aid appliance:**

These intermediate installation kits can be used to arrange the iron aid appliance and an automatic Electrolux washing machine (60cm wide, front loading) as a space-saving washer/iron aid stack. The automatic washing machine is at the bottom and the iron aid appliance is at the top.

Two versions can be supplied:

- without stacker plate
- with extractable stacker plate

Read the manual supplied with the installation kit carefully.

## Door reversal instructions

To make it easier to load or unload the laundry the door can be reversed. Reversing the door is not possible if after this operation the appliance result installed behind a door with hinge on the opposite side to that of the appliance.



**Warning!** The door may only be reversed by qualified personnel. If necessary, please contact your local Electrolux service centre.

## 42 electrolux service

### Service

In the event of technical faults, please first check whether you can remedy the problem yourself with the help of the operating instructions (section "What to do if...").

If you were not able to remedy the problem yourself, please contact the Customer Care Department or one of our service partners.

In order to be able to assist you quickly, we require the following information:

- Model description
- Product number (PNC)
- Serial number (S No.)  
(for numbers see rating plate)
- Type of fault
- Any error messages displayed by the appliance

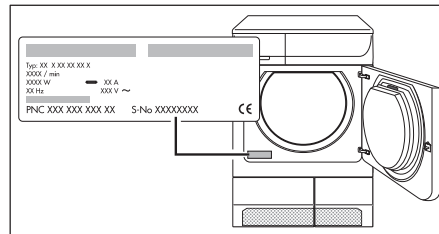

So that you have the necessary reference numbers from your appliance at hand, we recommend that you write them in here:

Model description: .....  
PNC: .....  
S No: .....

## Electrolux Warranty

FOR SALES IN AUSTRALIA AND NEW ZEALAND  
APPLIANCE: [Condenser Dryer]

This document sets out the terms and conditions of product warranties for Electrolux branded appliances. It is an important document. Please keep it with your proof of purchase documents in a safe place for future reference should you require service for your Electrolux appliance

**General Terms and Conditions**

1. In this warranty
  - (a) 'Electrolux' means Electrolux Home Products Pty Ltd ABN 51 004 762 341 in respect of Appliances purchased in Australia and Electrolux (NZ) Limited in respect of Appliances purchased in New Zealand;
  - (b) 'Appliance' means any Electrolux product purchased by you accompanied by this document;
  - (c) 'Warranty Period' means
    - (i) where you use the Appliance for personal, domestic or household purposes in Australia the period of 24 months and in New Zealand the period of 24 months;
    - (ii) where you use the Appliance for commercial purposes, in Australia the period of 3 months and in New Zealand the period of 3 months, (if the period stated is 0 months you are not covered by this product warranty) following the date of original purchase of the Appliance;
  - (d) 'you' means the purchaser of the Appliance not having purchased the appliance for re-sale, and 'your' has a corresponding meaning.
2. This warranty only applies to Appliances purchased and used in Australia or New Zealand and is in addition to (and does not exclude, restrict, or modify in any way) any non-excludable statutory warranties in Australia or New Zealand.
3. Electrolux warrants that, when dispatched from an Electrolux warehouse, the Appliance is free from defects in materials and workmanship for the Warranty Period.
4. During the Warranty Period Electrolux or its Authorised Service Centre will, at no extra charge if your appliance is readily accessible without special equipment, and subject to these terms and conditions, repair or replace any parts which it considers to be defective. You agree that any replaced Appliances or parts become the property of Electrolux. This warranty does not apply to light globes, batteries, filters or similar perishable parts.
5. Parts and Appliances not supplied by Electrolux are not covered by this warranty.
6. Where you are within an Electrolux service area, this warranty covers the cost of transport of the Appliance to and from Authorised Service Centres of Electrolux and travelling costs for representatives of the Authorised Service Centre to and from your home or business. If you are outside an Electrolux service area, you will bear these costs. For information about whether you are within an Electrolux service area, please phone 13 13 49 in Australia, or 0800 10 66 10 in New Zealand.
7. Proof of purchase is required before you can make a claim under this warranty.

8. You may not make a claim under this warranty unless the defect claimed is due to faulty or defective parts or workmanship. Electrolux is not liable in the following situations (which are not exhaustive):
  - (a) The Appliance is damaged by:
    - (i) accident
    - (ii) misuse or abuse, including failure to properly maintain or service
    - (iii) normal wear and tear
    - (iv) power surges, electrical storm damage or incorrect power supply
    - (v) incomplete or improper installation
    - (vi) incorrect, improper or inappropriate operation
    - (vii) insect or vermin infestation.
  - (b) The Appliance is modified without authority from Electrolux in writing.
  - (c) The Appliance's serial number or warranty seal has been removed or defaced.
  - (d) The Appliance was serviced or repaired by anyone other than Electrolux or its Authorised Service Centres.
9. This warranty, the contract to which it relates and the relationship between you and Electrolux are governed by the law applicable in the Australian State where the Appliance was purchased or the law applicable in New Zealand if the Appliance was purchased in New Zealand. Where the Appliance was purchased in New Zealand for business purposes the Consumer Guarantee Act does not apply.

### Limitation of Liability

10. To the extent permitted by law.
  - (a) Electrolux excludes all warranties other than as contained in this document;
  - (b) Electrolux shall not be liable for any loss or damage whether direct or indirect or consequential arising from your purchase, use or non-use of the Appliance.
11. Provisions of the Trade Practices Act and State consumer legislation in Australia, and the Consumer Guarantees Act, the Sale of Goods Act and the Fair Trading Act in New Zealand, imply warranties or conditions, or impose obligations, upon Electrolux which cannot be excluded, restricted or modified. To the extent permitted by law, the liability of Electrolux (if any) arising out of or in relation to the Appliance or any services supplied by Electrolux shall be limited (where it is fair and reasonable to do so):
  - (a) in the case of Appliances, at its option, to the replacement or repair of the Appliances or the supply of equivalent products or the payment of the cost of replacing the Appliances or having the Appliances repaired or of acquiring equivalent Appliances. Upon being replaced, parts and Appliances become the property of Electrolux; or
  - (b) in the case of services, at its option, to the supply of the services again or the payment of the cost of having the services re-supplied;
 and in the case of Appliances or services supplied in New Zealand, loss or damage whether direct or indirect or consequential that is reasonably foreseeable.

### Privacy

You acknowledge that in the event that you make a warranty claim it will be necessary for Electrolux and its Authorised Service Centres to exchange information in relation to you to enable Electrolux to meet its obligations under this warranty.

### Important Notice

Before Calling a Service Technician please check carefully the operating instructions, service booklet and the warranty terms and conditions.

<p><b>FOR SERVICE</b> OR TO FIND THE ADDRESS OF YOUR NEAREST STATE SERVICE CENTRE IN AUSTRALIA <b>Please call 13 13 49</b> <small>For the cost of a local call (Australia only)</small></p>	<p><b>SERVICE AUSTRALIA</b>  <b>ELECTROLUX HOME PRODUCTS</b></p>	<p><b>FOR SPARE PARTS</b> OR TO FIND THE ADDRESS OF YOUR NEAREST STATE SPARE PARTS CENTRE IN AUSTRALIA <b>Please call 13 13 50</b> <small>For the cost of a local call (Australia only)</small></p>
<p><b>FOR SERVICE</b> OR TO FIND THE ADDRESS OF YOUR NEAREST AUTHORISED SERVICE CENTRE IN NEW ZEALAND <b>Free call 0800 10 66 10</b> <small>(New Zealand only)</small></p>	<p><b>NEW ZEALAND SPARE PARTS CENTRES</b></p> <p><b>AUCKLAND</b> Prime Distributors Ltd. 8 Highbrook Drive, East Tamaki ..... (09) 273 3580  <b>WELLINGTON</b> Prime Distributors Ltd. 68 Victoria Street, Petone ..... (04) 586 2150  <b>CHRISTCHURCH</b> Prime Distributors Ltd. Unit 1, 127 Montreal Street ..... (03) 377 1009                      R. Redpath Ltd. 55 Ferry Road ..... (03) 379 0446  <b>DUNEDIN</b> South City Champion, 590 Hillside Road ..... (03) 455 5443</p> <p> <b>ELECTROLUX HOME PRODUCTS</b></p>	





[www.electrolux.com](http://www.electrolux.com)



125 986 590-00-18122006