

Built-in fan / steam oven

Electrolux. Thinking of you.

Share more of our thinking at www.electrolux.com

Contents

Safety information	2	Cleaning and servicing	32
Description of appliance	3	What to do if ...	36
Before Using for the first time	5	Installation Instructions	36
Operating the oven	6	Disposal	42
Usage, Tables and Tips	16	Service	42



Subject to change without notice

Safety information

Important safety instructions! Read carefully and keep for future use!

Electrical safety

- This appliance must only be connected by a **qualified installation engineer**.
- In the event of a fault or damage to the appliance: Take the fuses out or switch off.
- **Repairs** to the appliance must **only be carried out by qualified service engineers**. Considerable danger may result from improper repairs. If repairs become necessary, please contact our Customer Care Department or your dealer.

Children's safety

- Never leave children unsupervised while the appliance is operating.
- This appliance is fitted with a child safety device.

Safety during use

- This appliance should be used only for normal domestic cooking, roasting and baking of food.
- Be careful if connecting electrical appliances to sockets near to this appliance. Electrical leads must **not** be caught under the hot oven door.
- **Warning: Risk of burns!** The interior surfaces of the oven become very hot during use.
- **Warning: Do not under any circumstances open the oven door during steam cooking.** The escaping steam can cause moisture damage to units. Avoid any direct contact with the escaping steam.
- If you use ingredients containing alcohol in the oven, a slightly flammable mixture of

alcohol and air may ensue. In this case, be careful when opening the door. Do not handle any sources of heat, sparks or naked flames when doing so.

- People (including children), who, because of their physical, sensory or mental capabilities or their inexperience or ignorance, are not able to use the appliance safely, should not use this appliance without supervision by or instruction from a responsible person.



Information on acrylamides

According to the latest scientific knowledge, intensive browning of food, especially in products containing starch, can constitute a health risk due to acrylamides. Therefore we recommend cooking at the lowest possible temperatures and not browning foods too much.

How to avoid damage to the appliance

- Do not line the oven with aluminium foil and do not place a baking tray or saucepan etc. on the floor, as otherwise the oven enamel will be damaged by the heat build-up.
- Fruit juices dripping from the baking tray will leave stains, which you will not be able to remove. For very moist cakes, use a deep tray.
- Do not put any strain on the oven door when open.
- Never pour water directly into the oven when it is hot. This could cause damage to and discoloration of the enamel.
- Rough handling, especially around the edges of the front panel, can cause the glass to break.

- Do not store any flammable materials inside the oven. These could ignite when the oven is switched on.
- Do not store any moist foods inside the oven. This could cause damage to the enamel.
- Do not leave dishes uncovered in the oven after switching off the cooling fan. Moisture may form inside the oven or on the glass door and also get onto the units.

i Information on the oven enamel
Changes to the colour of the oven's enamel surface as a result of use do not affect the appliance's suitability for normal and correct use. They therefore do not constitute a defect in terms of warranty law.

Description of appliance

General Overview

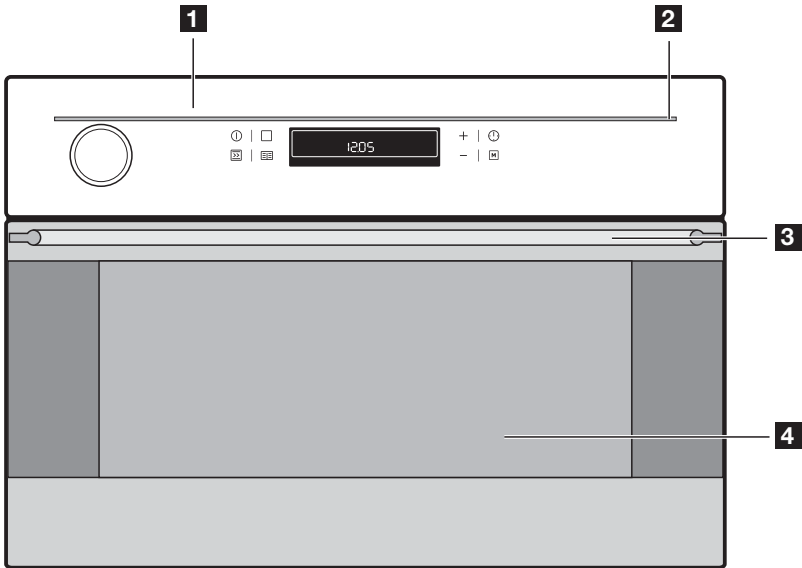

- 1** Control panel
- 2** Light bar
- 3** Door handle
- 4** Oven door

i The oven switches off after 2 minutes, if no function is selected and is changed at the oven nothing, the light remains

however on. In order to switch off the light bar, oven switch on with ① and switch off again.

Control Panel

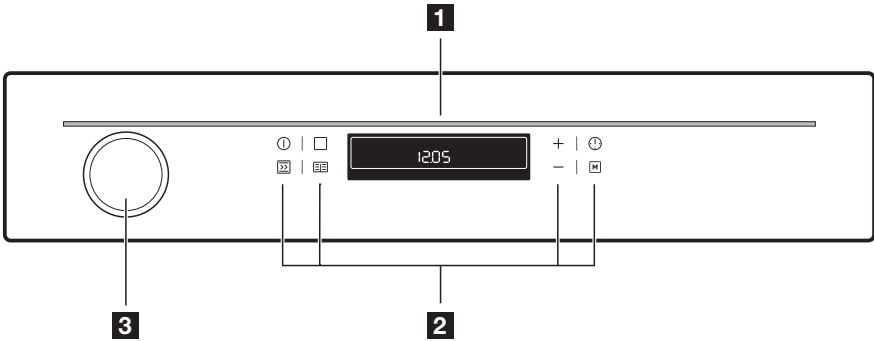

- 1** Oven display
- 2** Function buttons Oven
- 3** Water Drawer

Oven layout

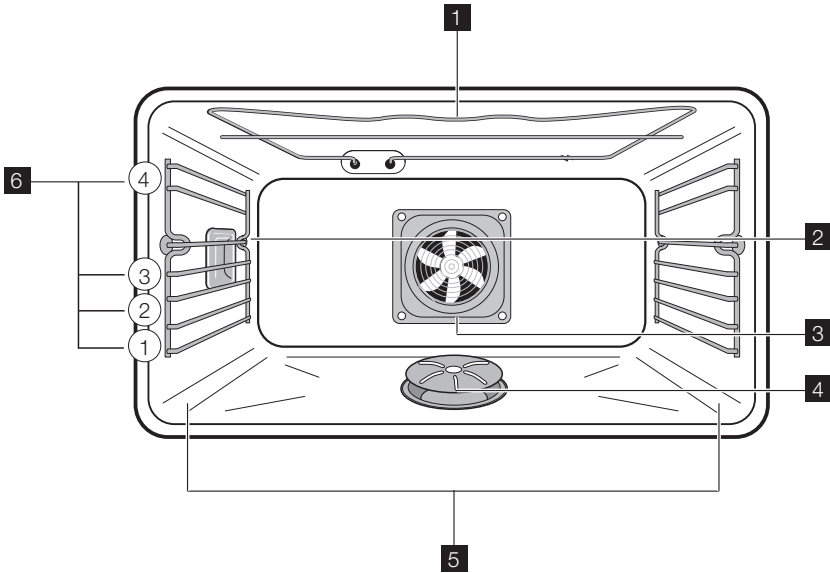

- | | |
|--------------------------------|------------------------------------|
| 1 Grill heating element | 4 Steam generator / rosette |
| 2 Oven light | 5 Side rails, removable |
| 3 Fan heating elements | 6 Oven levels |

Oven Accessories

Grill

For cookware, cake tins, roasts and grilling food.

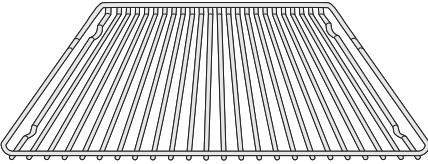

Quick Sponge 180

Extremely absorbent, ring-shaped sponge, adapted exactly to suit its function.

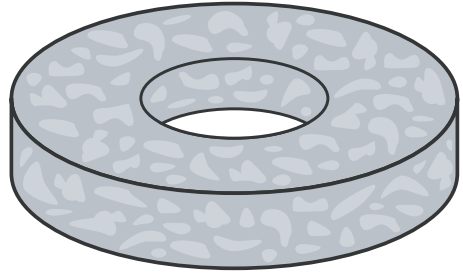

Baking tray

For cakes and biscuits.

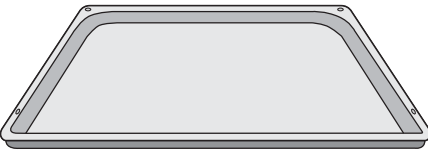



Before Using for the first time

Setting and changing the time

i The oven only operates when the time has been set.

When the appliance has been connected to the electrical supply or when there has been a power cut, the symbol for Time  automatically flashes.



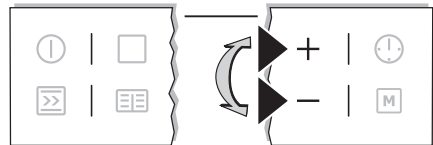

1. To change a time of day that has already been set, press the Clock Functions  button repeatedly until the symbol for Time  flashes.
2. Using the **+** or **-** button, set the current time.

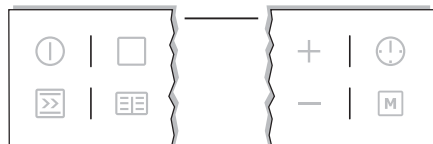

After about 5 seconds, the flashing stops and the clock displays the time of day set.



The appliance is now ready to use.

- i** The time can only be modified, if the child safety device is deactivated, none of the clock functions Countdown , Cook time  or End time  nor any oven functions are set.

Cleaning for the first time

Before you use the oven for the first time, you should clean it thoroughly.

Important! Do not use any sharp or abrasive cleaning tools or materials! These could damage the surface.

- i** For metal fronts, use normal commercially available cleaning agents.

1. Open the oven door.
The lighting in the oven is switched on.
2. Remove all accessories and side rails and clean with a warm solution of water and washing-up liquid.
3. Also wipe the oven out with a warm solution of water and washing-up liquid and then dry it.
4. Wipe the front of the appliance with a damp cloth.

Getting to know the appliance



The appliance can be operated in test mode for testing or performing all operating steps. The oven does not heat up.

Switching on test mode

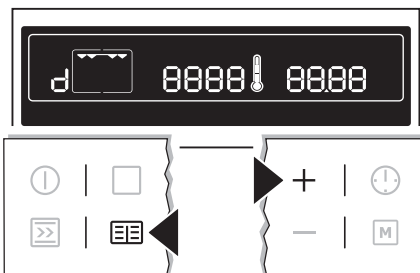
1. Switch the appliance off with the On/Off button .
2. Press and hold baking/roasting programme buttons  and  at the same time until an acoustic signal sounds and "d" lights up in the display.



Switching off test mode

1. Switch the appliance off with the On/Off button .
2. Press and hold baking/roasting programme buttons  and  at the same time until an acoustic signal sounds and "d" goes out in the display.

Operating the oven

The electronic oven controls

The display field

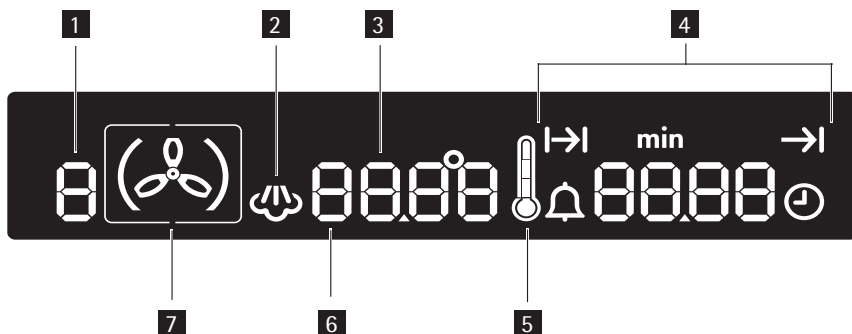

- 3 Temperature/Time
- 4 Clock functions/Operating time
- 5 Thermometer symbol

- 6 Baking/Roasting Programmes
- 7 Cooking Functions

Control panel

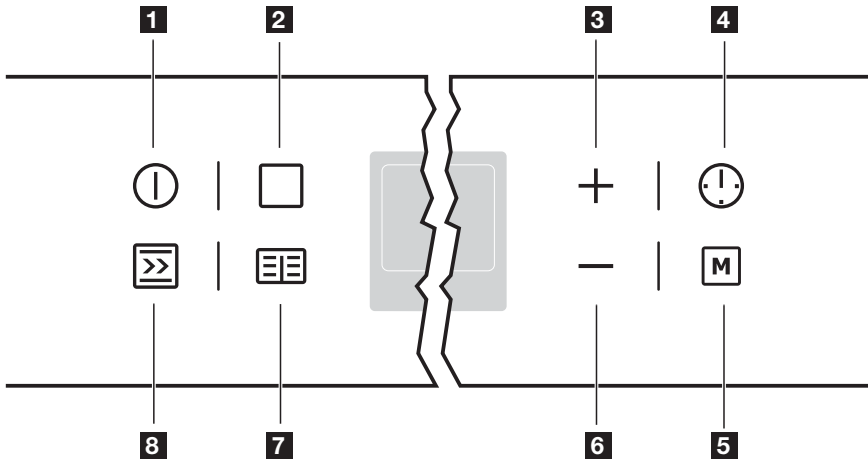

- 1 On/Off button
- 2 Oven function selection
- 3 button +
- 4 Clock functions

- 5 Memory function
- 6 button -
- 7 Baking/Roasting Programmes
- 8 Fast warm up

General instructions

- First of all switch the appliance off with the On/Off button ①.
- When the selected function lights up, the oven begins to heat up or the time set begins to count down.
- When the selected temperature is reached, a signal sounds.
- The oven light is switched on as soon as an oven function is started or the oven door is opened.
The oven light goes off after 10 minutes when the door is open and the appliance switched off.
- Switch the appliance off with the On/Off button.

Selecting the oven function

1. Switch the appliance on with the On/Off button ①.

2. Press  repeatedly until the required oven function appears.

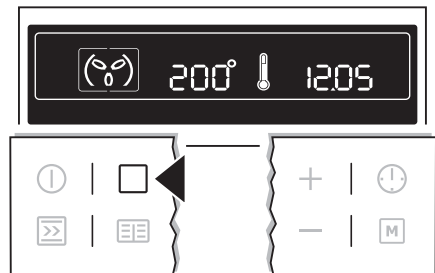

- A suggested temperature appears in the temperature display.
- If the suggested temperature is not changed within approx. 5 seconds, the oven begins to heat up.

Changing the oven temperature

Use the **+** or **-** button to increase or lower the temperature.

The setting changes in 5°C increments.

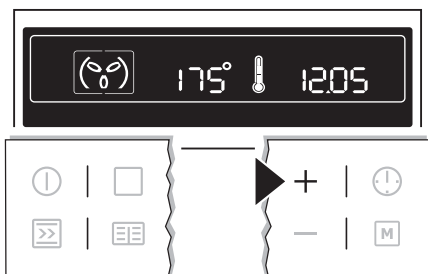

Thermometer symbol

- The slowly rising thermometer symbol indicates how far the oven has already heated up.
- The three segments of the thermometer symbol flashing one after the other show that Fast Warm Up mode is on.

Changing the oven function

To change the oven function press the oven function button repeatedly until the required oven function appears.

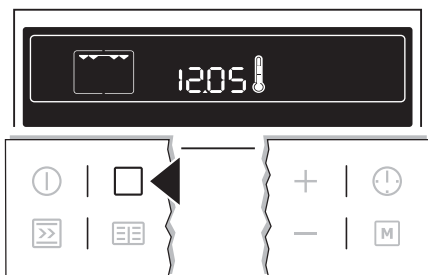

Switching off the oven

Switch the appliance off with the On/Off button.

Cooking Functions

Oven function	Use
Steam cooking	For vegetables, potatoes, rice, pasta or other side-dishes.
Interval steam cooking	For baking, roasting and warming up chilled and frozen meals.
Fan oven with circular heating element	For cooking and baking on up to two shelves at the same time.

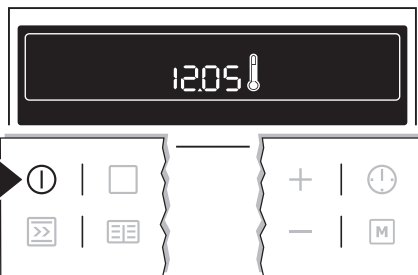

Cooling fan

The fan switches on automatically to keep the appliance surfaces cool. When the oven is switched off, the fan continues to run to cool the appliance down and then switches itself off.





Speedcook

After an oven function has been selected, using the additional function Speedcook the empty oven can be pre-heated in a relatively short time.

Important! Do not put the food to be cooked into the oven, until Speedcook is completed and the oven is operating using the desired function.

1. Set and start the desired oven function (e.g. Convection with ring heating element). If necessary, change the suggested temperature.
2. Press the Speedcook button. The symbol lights up.

When the bars flash one after another it shows that Speedcook is operating. When the temperature set is reached, the bars of the heat indicator are lit. An acoustic signal sounds. The symbol goes out. The oven now continues heating according to the pre-set oven function and temperature. You can now place the food in the oven.

Oven function		Use
	Hot air grilling	For roasting larger pieces of meat or poultry on one shelf. The function is also suitable for cooking "au gratin" and browning .
	Grill	For grilling flat foods and for toasting .
	Defrosting/ drying	For defrosting and drying herbs, fruit or vegetables.
	Low temperature cooking	For preparing particularly tender, succulent roasts.
	Moist fan cooking	For energy-saving baking and cooking of mainly dry bakery items as well as baking in tins on one level.

Inserting the Oven Shelf and the Baking Tray

i Shelf runner safety and anti-tip device

As a shelf runner safety device, all insertable components have a small curved indentation at the bottom on the right and left-hand edge.

Always insert insertable components so that this indentation is at the back of the oven interior. This indentation is also important for preventing the insertable components from tipping.

Inserting the baking tray

Push the baking tray between the guide bars of the selected oven level.

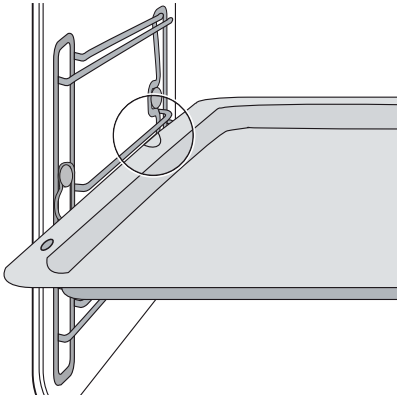

Inserting the oven shelf:

Insert the oven shelf so that the feet point downwards.
Push the oven shelf between the guide bars of the selected oven level.

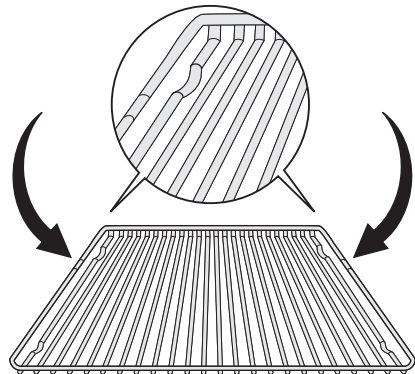

i The high rim around the oven shelf is an additional device to prevent cookware from slipping.

Steam cooking functions

Important! The steam cooking functions must always be set in conjunction with the Cooking Time $\rightarrow|$ or End Time clock functions $\rightarrow|$ (see Cooking time $\rightarrow|$ / End Time $\rightarrow|$ cooking function section).

Important! Only water can be used as the liquid!

A buzzing sound is heard when the water has been used up. The buzzing tone switches off again shortly after the water has been topped up.

i Due to the automatic steam dispersal period of about 5 minutes at the end of the cooking time and the pre-heating time of approx. 2 minutes, settings under 10 minutes have little effect.



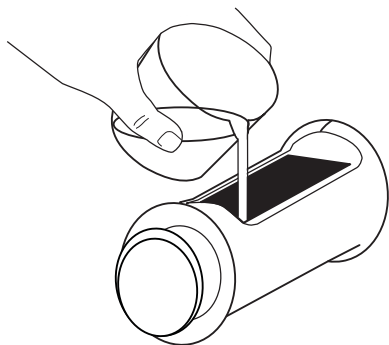

Steam will also escape when the door is opened.

Steam cooking

1. Do not fill the water (approx. 700 ml) directly into the steam generator, but **into the water drawer** in the control panel



The water supply lasts for approx. 30 minutes.

2. Switch the oven on with the On/Off  button.
3. Using the oven functions  button, select steam cooking  and using the $+$ or $-$ button, set the desired temperature (Range 50°C - 96°C°).
4. Using the clock function  button, select Cooking Time \rightarrow or End Time \rightarrow and using the $+$ or $-$ button, set the desired cooking time or switch-off time. After approx. 2 minutes, the first steam appears. A single audible signal indicates when the cooking temperature of approx. 96°C is reached.

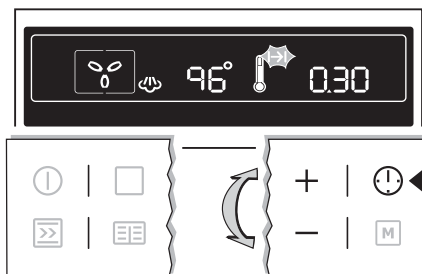

A triple beep indicates the end of cooking time.





5. Stop the signal and switch the oven off by pressing the On/ Off  button

After the oven has cooled down, soak up any remaining water from the steam generator using a sponge and wipe if necessary with a few drops of vinegar.

Leave the door open to let the oven dry completely.

Interval cooking

The continual change from hot air to steam takes place automatically.

1. Do not fill the water (approx. 250 ml) directly into the steam generator, but **into the water drawer** in the control panel
2. Switch the oven on with the On/Off  button.
3. Using the oven function button , select the interval steam cooking function  and using the $+$ or $-$ button set the desired temperature.
4. Using the clock function  button, select Cooking Time \rightarrow or End Time \rightarrow and using the $+$ or $-$ button, set the desired cooking time or switch-off time.

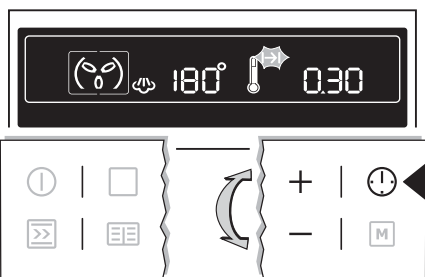



Then proceed as for steam cooking .

Additional functions

Baking/roasting programmes

-  Use the pre-set recipes for this function.

Selecting the programme

1. Switch the oven on with the On/Off  button. Press the baking/roasting programme button  repeatedly until the required programme appears on the display (P1 - P12).

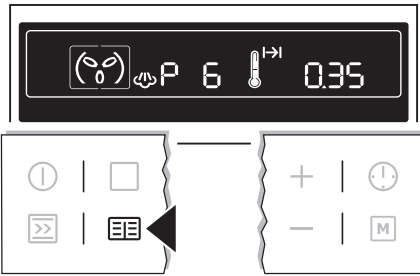

- The symbol for the associated oven function appears on the function display.
 - The cooking time appears on the time display and the cooking time I→I symbol lights up.
 - Press the Clock function (🕒) button, then press the + or - button, to change the cooking time.
 - After approx. 5 seconds, the oven switches itself on.
2. When the time has elapsed, a signal sounds for 2 minutes. The cooking time symbol I→I flashes. The oven switches itself off.
 3. The signal can be stopped by pressing any button.

Delaying the start

The start of cooking time can be delayed (see end of cooking time clock function →🕒).

Ending cooking time early

Switch the oven off with the On/Off (🔌) button.

Memory function

You can use the memory function to save **one** setting that is used over and over again.

1. Set oven function, temperature and if necessary the cooking time I→I and/or end time →🕒 clock function.

2. Hold down the memory function button **M** for about 2 seconds until a signal sounds. The setting is saved.

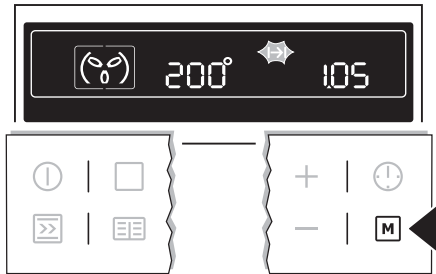

- i** To save another setting press the memory function button again **M** for about 2 seconds. The previously saved setting is replaced by the new one.

Starting the memory function

1. Switch the oven on with the On/Off (🔌) button.
2. Call up the saved setting with the memory function button **M**.

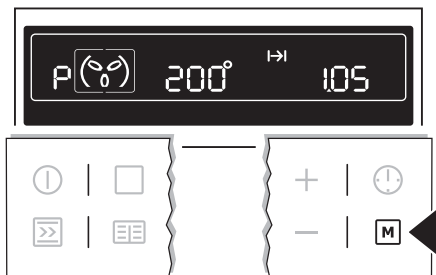

Clock functions

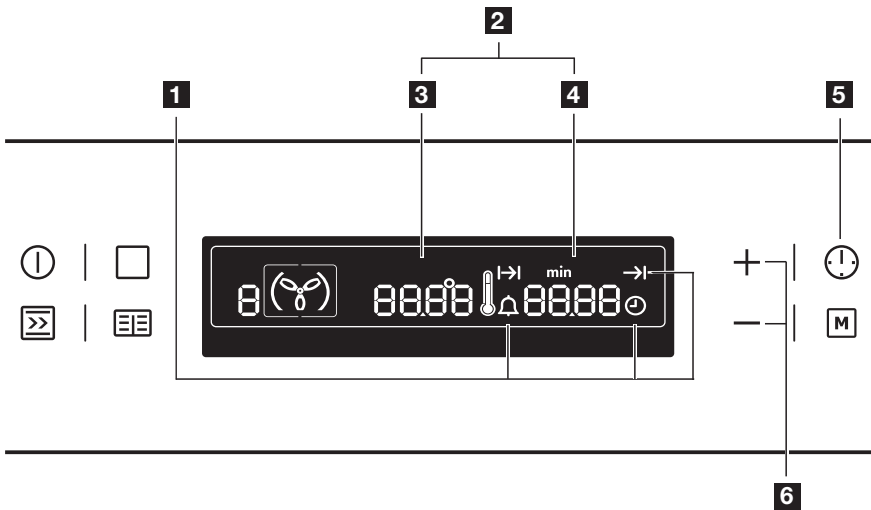

- 1 Clock functions
- 2 Clock displays
- 3 Time
- 4 Cooking/end/operating time
- 5 Clock functions
- 6 Selector buttons

Count down

To set a count down. When it has counted down, a signal sounds. This function has no effect on the oven.

Cooking time I->

To set how long the oven is to operate.

End Time ->I

For setting when the oven is to switch itself off again.

Time

To set, change or find out the time (see section Before using for the first time).



General instructions

- After a clock function has been selected, the corresponding symbol flashes for about 5 seconds. During this time press + or - to set or change the required times.
- When the desired time has been set, the symbol continues to flash for approx. 5 seconds. After this the symbol lights up.

The set count down time  begins to count down.

- The time set for cooking time I-> and end time ->I begins to count down after you have started the selected function.

Count down

1. Press the clock function button  repeatedly until the count down symbol  flashes.

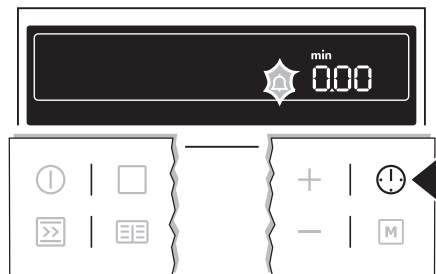

- Press $+$ or $-$ to set the required count down time (max. 99.00 minutes).

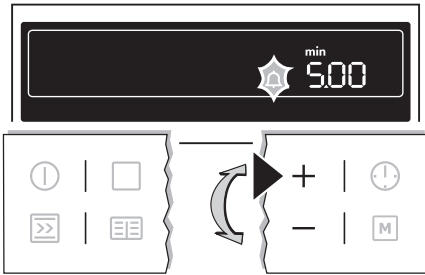

After approx. 5 seconds the display shows the time remaining. The Count down symbol ⏰ lights up.

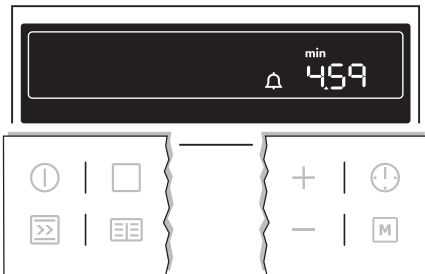

When the time has elapsed, a signal sounds for 2 minutes. "0.00" lights up and the count down symbol ⏰ flashes. To turn the signal off: Press any button.

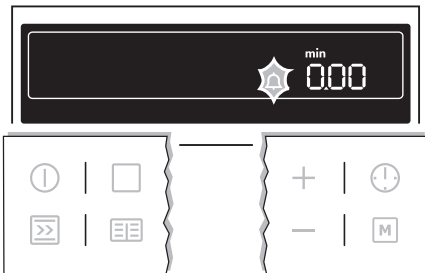

Select cooking time $\text{I}\rightarrow$

- oven mode and select temperature with $+$ or $-$.
- Press the clock function button ⌚ repeatedly until the cooking time symbol $\text{I}\rightarrow$ flashes.

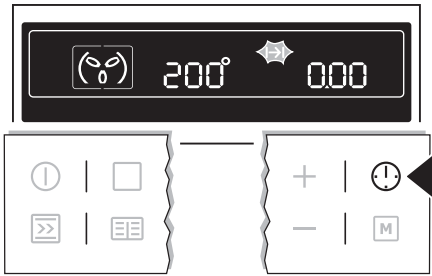

- Press $+$ or $-$ to set the desired cooking time.

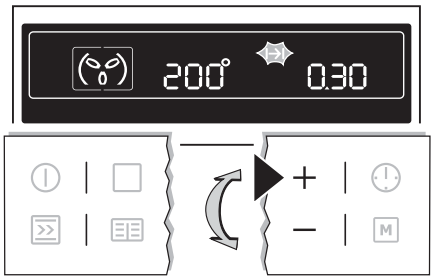

The oven switches itself on. The Cooking time symbol $\text{I}\rightarrow$ lights up.

- i** Press the clock function button ⌚ repeatedly to retrieve the current time.

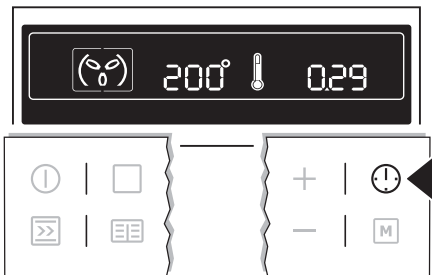

When the time has elapsed, a signal sounds for 2 minutes. The oven switches itself off. "0.00" lights up and the cooking time symbol $\text{I}\rightarrow$ flashes.

To turn the signal off: Press any button.

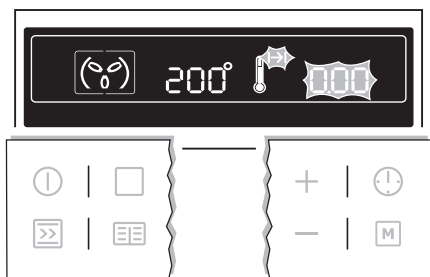

Select End time →

1. oven mode and select temperature with **+** or **-**.
2. Press the clock function button repeatedly until the end time symbol **→** flashes.

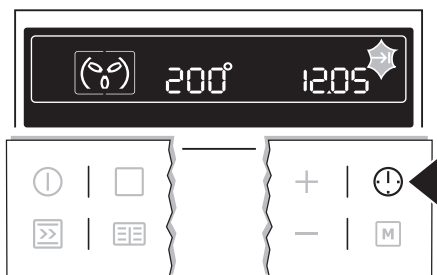

3. Press **+** or **-** to set the time you want the appliance to switch off.

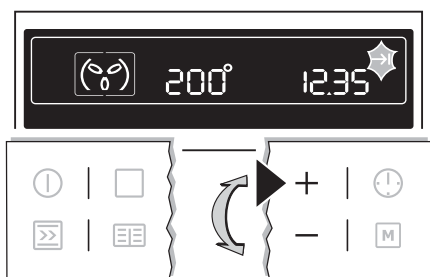

The symbols for end time **→** and cooking time **|→** light up.

The oven switches itself on automatically.

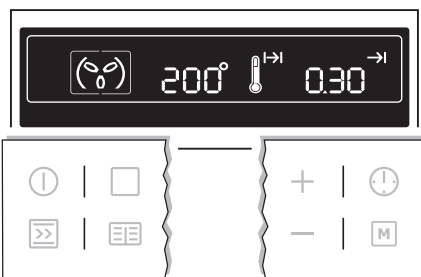

- i** Press the clock function button repeatedly to retrieve the current time.

When the time has elapsed, a signal sounds for 2 minutes. The oven switches itself off. "0.00" is displayed and the end time **→** and cooking time symbols **|→** flash.

To turn the signal off: Press any button.

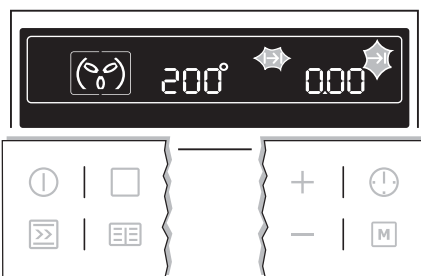

Cook Time |→ and End Time → combined

- i** The Cooking Time **|→** and the End Time **→** can be used simultaneously if the oven is to be switched on and off automatically at a later time.

1. Select oven function and temperature.
2. Use the cooking time function **|→** to set the time that the dish needs to cook, e.g. 1 hour.

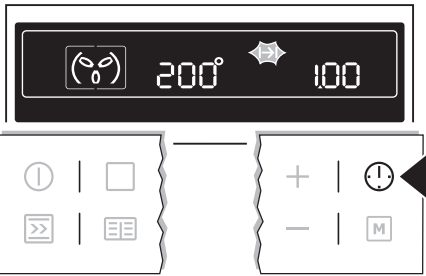

3. Use the end time function $\rightarrow I$ to set the time when the dish will have finished cooking, e.g. 14:05.

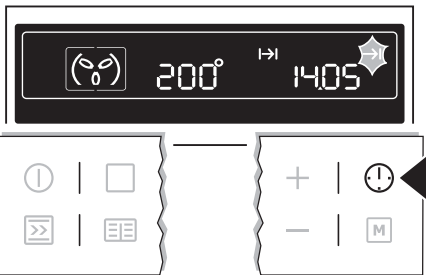

The symbols for cooking time $I \rightarrow I$ and end time $\rightarrow I$ light up.
The oven switches itself on automatically at the time calculated, e.g. 13:05.
When the set cook time has elapsed a signal sounds for 2 minutes and the oven switches itself off, e.g. 14:05.

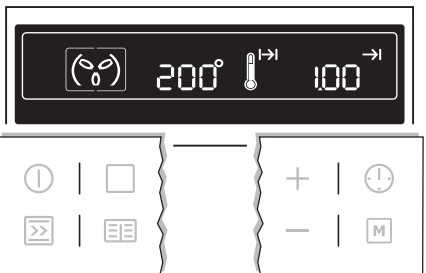

Other functions

Child Safety Function

As soon as the child safety device is activated it is no longer possible to operate the oven.

Switching on the child safety device

1. If necessary switch the appliance off with the On/Off button ⓪ . Make sure no oven function is selected.
2. Press the ≡ and — cooking programme buttons at the same time until **SAFE** appears on the display.



The child safety device is now activated.

Switching off the child lock

1. If necessary switch the appliance off with the On/Off button ⓪ .
2. Press the ≡ and — cooking programme buttons at the same time until **SAFE** goes out.

The child safety device is now deactivated and the appliance is again ready for use.

Beep button

Switching off beep button

1. If necessary switch the appliance off with the On/Off button .
2. Hold down **+** and **-** at the same time until a beep sounds (approx. 2 seconds).

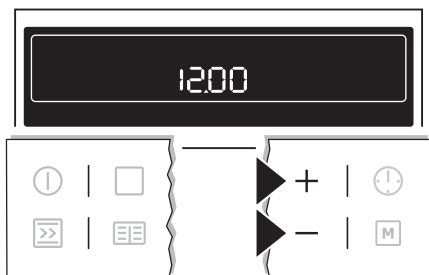

The beep button is now switched off.

Switching on beep button

Hold down **+** and **-** at the same time until a beep sounds (approx. 2 seconds).
The beep button is switched on again.

Automatic oven switch-off

- i** If the oven is not switched off after a certain time or if the temperature is not modified it switches off automatically. The last temperature set appears in the temperature display.

The oven switches itself off at an oven temperature of:

30 - 120° C after 12.5 hours

120 - 200° C after 8.5 hours

200 - 230° C after 5.5 hours



OFF appears on the display.

Starting up after an automatic switch-off

Switch the oven off completely. It can then be operated again.

Usage, Tables and Tips

Steam cooking

For steam cooking, use the oven functions Steam Cooking  or Interval Steam Cooking .

! **Warning!** Never open the oven door during the steam cooking .

Important! Only water can be used as the liquid!

Cookware for steam cooking

- Cookware made of an appropriate heat and corrosion resistant material is suitable for steam cooking.
- Chrome steel food containers are very suitable (see special accessories).

Shelf positions

- The appropriate shelf positions can be found in the following table. Shelf positions are counted from the bottom to the top.

General instructions

- For cooking times longer than 30 minutes or when cooking larger quantities of food top up water, if necessary.

- If the appliance is not used for prolonged periods, thoroughly rinse out the water drawer, connecting hoses and steam generator (see section Cleaning and Care.).

Note on the tables for Steam Cooking and Interval Steam Cooking

The tables below give the required temperature settings, cooking times and shelf positions for a selection of typical dishes.

- Temperatures and cooking times are for guidance only, as these will depend on the composition and size of the food to be cooked, the quantity and the type of ovenware.
- If you cannot find the settings for a particular recipe of your own, look for the one that is most similar.
- Unless otherwise stated, the values given in the tables assume that cooking is started with the oven cold.

Steam cooking

The Steam Cooking  method of cooking is suitable for all types of food, whether fresh or frozen. It can be used for cooking, warming, defrosting, poaching, or blanching vegetables, meat, fish, pasta, rice, sweet corn, semolina and eggs.

Cooking menus

Steam Cooking Table

Food to be roasted	Water to add via water drawer ml	Temperature °C	Shelf position	Time ¹⁾ in min.
Risotto	400	96	2	25-30
Rice (with liquid 1:1)	650	96	2	35-40
Cornmeal (polenta, with liquid 1:3)	550	96	2	35-40
Jacket potatoes, medium-sized	650	96	2	50-60
Boiled potatoes	550	96	2	35-40
Ratatouille	400	96	2	25-30
Brussels sprouts	550	96	2	30-35
Broccoli in florets	550	96	2	25-30
Cauliflower, whole	650	96	2	40-45
Cauliflower in florets	600	96	2	30-35
Herbs	650	96	2	50-60
Tomatoes, whole	250	96	2	15-20
Beetroot, whole	550	96	2	60-70
Kohlrabi/celery/fennel	550	96	2	35-40
Courgettes, sliced	400	96	2	20-25

Complete menus can be prepared in one go. Ideally, dishes that require similar cooking times should be chosen. This will prevent individual components from being under or over cooked. The amount of water to be used will depend on the largest amount of water specified for the individual components chosen. For further information, see table.

The dishes should be positioned in suitable cooking containers on the oven shelves. The gap between the oven shelves must be adjusted so that the steam can get to every dish.

When cooking meals, the share of water to rice is to be increased from 1 : 1.5 to 1 : 2 in contrast to the specifications in the table.



Sterilising containers

The Steam Cooking  function makes it possible to sterilise containers, e.g. babies' bottles using steam. To do this place the cleaned containers in the middle of the oven shelf on the 1st shelf position with the opening facing downwards. Insert the containers into the oven at a slight angle. Fill the maximum amount of water (650 ml) and select a time of 40 min. at 96°C.

Food to be roasted	Water to add via water drawer ml	Temperature °C	Shelf position	Time ¹⁾ in min.
Carrots, sliced	550	96	2	35-40
Defrosting vegetables	550	96	2	35
Defrosting and cooking vegetables	650	60	2	35-40
Blanching vegetables	250	96	2	12-15
Blanching beans	250	96	2	20-22
Frozen beans	650	96	2	30-40
Chicken (breast)	500	96	2	30-40
Nuss-Schinken (prosciutto-style ham) 1,000 g	650	96	2	50-75
Kasseler (Smoked loin of pork) 600-1,000 g	650	96	2	45-55
Stuffed pepper	500	96	2	30-40
Frankfurters / veal sausages	250	85	2	15-20
Warming up meat loaf in 1 cm slices	400	96	2	20-25
Fish fillet, approx. 1,000 g	650	96	2	35-40
Flat fish fillet, approx. 300 g	300	80	2	15-20
Fish fillet, frozen 500-800 g	650	96	2	30-40
Trout, 170-300 g	400	85	2	15-25
Custard / flan in individual dishes	500	96	2	25-35
Egg royale (baked egg soup garnish)	500	96	2	25-35
Steamed buns	500	96	2	30-35
Eggs, soft	200	96	2	8-10
Eggs, medium	200	96	2	10-12
Eggs, hard	200	96	2	15-20

1) The times given are for guidance only, they will vary depending upon size and quantity.

Fan oven with circular heating element and steam cooking in sequence

Using a combination of the fan oven with the circular heating element  and steam cooking  , meat, vegetables and side dishes can be cooked in the oven one after another and then using the steam cooking function , with each other so that these can be served together  .

- Brown the food to be cooked using the fan oven with circular heating element oven function  .

- Put prepared vegetables and side-dishes in oven-proof dishes and place in the oven with the roast.
- Start the Steam Cooking function  and cook it all together until ready.





 To be able to start the Steam Cooking function  , the oven must be cooled down to a temperature of approx. 80°C (check temperature display). For faster cooling, open the oven door.

Table for fan oven with circular heating element and steam cooking in sequence

Food to be roasted	Fan oven with circular heating element 		Steaming  (add max. of 650ml water)	
	Temp. in °C	MeatTime in min.	Meat and side-dishes, time in min.	Shelf positions
Roast beef, 1 kg Brussels sprouts, polenta	180	60-70	30-35	1 3
Roast pork, 1 kg Potatoes, vegetables Gravy	180	60-70	30-35	1 3
Roast veal, 1 kg Rice, vegetables	180	50-60	30-35	1 3

The times and temperatures given are for guidance only. They will vary depending upon size and quantity. The core temperature for meat should be between 60-63°C prior to switching to steam cooking.

ing or re-heating portions of previously cooked food.



Interval cooking

Interval Steam cooking is particularly suitable for roasting large joints of meat and defrost-

Interval steam cooking table



Cooking on more than one shelf position			
Food to be roasted	Interval cooking  (add max. of 250ml water)		
	Temperature in °C	Time in min.	Shelf positions
Warming meal, 6 plates, 24 cm in diameter	110	15-20	2 and 4
Roast pork, 1,000 g	180	90-100	2
Roast beef, 1,000 g	180	90-100	2
Roast veal, 1,000 g	180	80-90	2
Meat loaf, raw 500 g	180	30-40	2
Frankfurters / veal sausages	85	15-20	2
Kasseler (smoked loin of pork) 600-1,000 g (pre-soak for 2 hours)	180	60-70	2
Chicken, 1,000 g	200	45-55	2
Duck 1,500-2,000 g	180	60-75	2
Goose, 3,000 g	170	130-170	1
Fish fillet	90	20-30	2
Potato gratin, leek and potato gratin	190	40-50	2
Pasta bake	180	35-45	2
Lasagna	180	45-50	2
Misc. types of bread 500-1,000 g	180-190	50-60	2
Rolls, 40-60 g	210-220	20-25	3
Ready-to-bake rolls, 30-40 g	220	10-15	3

Cooking on more than one shelf position

Food to be roasted	Interval cooking   (add max. of 250ml water)		
	Temperature in °C	Time in min.	Shelf positions
Ready-to-bake rolls, 30-40 g, frozen	220	10-15	3
Ready-to-bake baguettes, 40-50 g	200	10-15	3
Ready-to-bake baguettes, 40-50 g, frozen	200	10-15	3



Carve whole roasts before warming up. The times and temperatures given are for guidance only. They will vary depending upon size and quantity.

Baking



Oven function: Fan oven with circular heating element  or moist fan cooking 



Baking tins

- When using the fan oven with the circular heating element  or moist fan cooking , light metal tins are suitable.

Shelf positions

- Baking with moist fan cooking  is possible on one level.
- When using the fan oven with the circular heating element  you can bake on up to two baking trays at the same time:

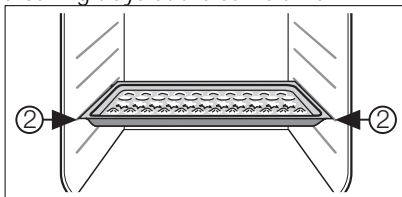

1 baking tray:

e. g. shelf position 2

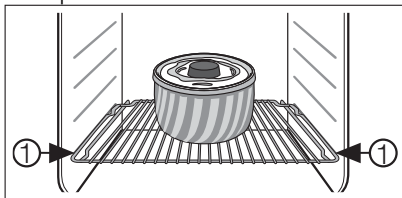

1 baking tin:

e. g. shelf position 1

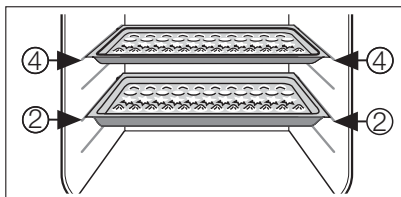

2 baking trays:

e. g. shelf positions 2 and 4

General instructions

You can also bake with two cake tins next to one another on the oven shelf at the same time. This only slightly increases the baking time.

-  If using frozen food, the inserted trays can warp during the cooking process. This is due to the large temperature difference between the frozen food and the oven temperature. After the trays have cooled, the warping disappears.

Information about the baking tables

The following charts give the required temperature settings, cooking times and shelf positions for a selection of dishes.

- Temperatures and baking times are for guidance only, as these will depend on the consistency of the mixture, the quantity and the type of baking tin.
- We recommend using the lower temperature the first time and then if necessary, e. g. if a more intense browning is required or baking time is too long, selecting a higher temperature.
- If you cannot find the settings for a particular recipe of your own, look for the one that is most similar.
- Extend baking time by 10-15 minutes if you are baking cakes on baking trays or in tins on more than one level.
- Moist bakery items (e. g. pizzas, fruit flans, etc.) are baked on one level.

- Differences in the height of the items can cause differences in the degree of browning at the beginning of the baking process. You should **not change the temperature setting** if this occurs. Different rates of browning even out as baking progresses.
- Your new oven may bake or roast differently to your previous appliance. If this is the case, adjust your normal settings (temperature, cooking times) and shelf posi-

















tions to the recommendations in the following charts.



With longer baking times, you can switch the oven off about 10 minutes before the end of baking time to make use of the residual heat. Unless otherwise stated, the values given in the tables assume that cooking is started with the oven cold.

Baking table

Type of baking	Baking on one shelf position				
	Oven functions	Shelf position	Temperature °C	Time in hrs: Min.	
Baking in tins					
Ring cake or brioche		Fan oven with circular heating element	1	160-170	0:50-1:10
Madeira cake/Fruit cakes		Fan oven with circular heating element	1	150-170	1:10-1:30
Sponge cake		Fan oven with circular heating element	1	160-180	0:25-0:40
Flan base - shortcrust pastry		Moist fan cooking	2	170-190 ¹⁾	0:10-0:25
Flan base - sponge mixture		Moist fan cooking	2	150-170	0:20-0:25
Apple tart (covered)		Fan oven with circular heating element	1	160-180	0:50-1:00
Apple pie (2 tins, Ø 20cm, placed diagonally)		Fan oven with circular heating element	1	180-190	1:05-1:20
Savoury flan (e. g. quiche Lorraine)		Fan oven with circular heating element	2	170-190	0:30-1:10
Cheesecake		Fan oven with circular heating element	1	160-180	1:00-1:30
Cakes/pastries/breads on baking trays					
Plaited bread/bread crown		Moist fan cooking	1	160-180	0:30-0:40
Christmas stollen		Fan oven with circular heating element	1	160-180	0:40-1:00
Bread (rye bread)		Fan oven with circular heating element	1	180-200	0:45-0:60
Cream puffs/éclairs		Fan oven with circular heating element	2	170-190	0:30-0:40
Swiss roll		Fan oven with circular heating element	2	200-220 ¹⁾	0:08-0:15
Cake with crumble topping (dry)		Moist fan cooking	2	160-180	0:20-0:40
Butter/sugar cake		Moist fan cooking	2	180-200 ¹⁾	0:15-0:30

Baking on one shelf position					
Type of baking	Oven functions	Shelf position	Temperature °C	Time in hrs: Min.	
Fruit flan (made with yeast dough/sponge mixture)	 Fan oven with circular heating element	2	160-180	0:25-0:50	
Fruit flan made with shortcrust pastry	 Fan oven with circular heating element	2	170-190	0:40-1:20	
Yeast cakes with delicate toppings (e. g. quark, cream, custard)	 Fan oven with circular heating element	2	150-170	0:40-1:20	
Pizza (with a lot of topping)	 Fan oven with circular heating element	2	190-210 ¹⁾	0:20-0:40	
Pizza (thin)	 Fan oven with circular heating element	2	230 ¹⁾	0:12-0:20	
Flat bread	 Fan oven with circular heating element	2	230 ¹⁾	0:10-0:20	
Swiss flaky pastry tarts	 Fan oven with circular heating element	2	190-210	0:35-0:50	
Biscuits					
Short pastry biscuits	 Fan oven with circular heating element	2	160-180	0:06-0:20	
Viennese whirls	 Fan oven with circular heating element	2	160	0:10-0:40	
Biscuits made with sponge mixture	 Fan oven with circular heating element	2	160-180	0:15-0:20	
Pastries made with egg white, meringues	 Fan oven with circular heating element	2	80-100	2:00-2:30	
Macaroons	 Fan oven with circular heating element	2	100-120	0:30-0:60	
Small raised pastries	 Moist fan cooking	2	160-180	0:20-0:40	
Puff pastries	 Fan oven with circular heating element	2	180-200 ¹⁾	0:20-0:30	
Rolls	 Fan oven with circular heating element	2	210-230	0:20-0:35	
Small cakes (20 per tray)	 Fan oven with circular heating element	2	170 ¹⁾	0:20-0:30	

1) Pre-heat oven

Baking on more than one shelf position			
Type of baking	Fan oven with circular heating element 	Temperature in °C	Time in hrs: Min.
	Shelf position from the bottom 2 levels		
Biscuits			
Short pastry biscuits	2 / 4	160-180	0:15-0:35
Viennese whirls	2 / 4	160	0:20-0:60





Type of baking	Baking on more than one shelf position		
	Fan oven with circular heating element  Shelf position from the bottom 2 levels	Temperature in °C	Time in hrs: Min.
Biscuits made with sponge mixture	2 / 4	160-180	0:25-0:40
Pastries made with egg white, meringues	2 / 4	80-100	2:10-2:50
Macaroons	2 / 4	100-120	0:40-1:20
Danish pastries	2 / 4	160-180	0:30-0:60
Puff pastries	2 / 4	180-200 ¹⁾	0:30-0:50





1) Pre-heat oven.

Tips for baking

Baking results	Possible cause	Remedy
The cake is not browned enough at the bottom	Wrong oven level used	Place cake lower in the oven
The cake sinks (becomes soggy, lumpy, streaky)	Oven temperature too high	Use a slightly lower temperature setting
	Baking time too short	Increase baking time. Baking times cannot be reduced by using a higher baking temperature
	Too much liquid in the mixture	Use less liquid. Pay attention to mixing times, especially if using mixing machines
Cake is too dry	Temperature too low	Use a higher oven temperature setting
	Baking time too long	Reduce baking time
Cake browns unevenly	Oven temperature too high and baking time too short	Use a lower oven temperature setting and increase baking time
	Cake mixture/dough is unevenly distributed	Spread the mixture/dough evenly on the baking tray
Cake is not done within the baking time given	Temperature too low	Use a slightly higher oven temperature setting





Bakes and browned dishes

Type of dish	Oven function		Shelf position	Temperature °C	Time in hrs: Min.
Pasta bake		Moist fan cooking	1	180-200	0:30-0:50
Lasagna		Fan oven with circular heating element	1	180-200	0:25-0:40
Vegetable gratins ¹⁾		Fan oven with circular heating element	1	160-170	0:15-0:30
Baguettes with topping ¹⁾		Fan oven with circular heating element	1	160-170	0:15-0:30

Type of dish	Oven function	Shelf position	Temperature °C	Time in hrs: Min.
Sweet bakes	 Moist fan cooking	1	180-200	0:40-1:00
Fish bakes	 Fan oven with circular heating element	1	180-200	0:30-1:00
Stuffed vegetables	 Fan oven with circular heating element	1	160-170	0:30-1:00
Potato gratin	 Moist fan cooking	2	180-200	0:40-0:50

1) Pre-heat oven

Frozen ready meals table

Food to be cooked	Oven function	Shelf position	Temperature °C	Time
Frozen pizza	 Fan oven with circular heating element	3	as per manufacturer's instructions	as per manufacturer's instructions
Chips 1) (300-600 g)	 Fanned grilling	3	200-220	as per manufacturer's instructions
Baguettes	 Fan oven with circular heating element	3	as per manufacturer's instructions	as per manufacturer's instructions
Fruit cake	 Fan oven with circular heating element	3	as per manufacturer's instructions	as per manufacturer's instructions

1) Turn chips 2 or 3 times during cooking

Roasting

oven function: Fan oven with circular heating element 

Ovenware for roasting

- Any heat-resistant ovenware is suitable for roasting. (Please follow the manufacturer's instructions.)
- We recommend roasting any lean meat **in a roasting dish with a lid**. The meat will be more succulent.
- You can roast any meat that is to be browned or have crackling in a **roasting dish without a lid**.

 Tips on using the roasting table

The information given in the following table is for guidance only.

Roasting table

Food to be roasted	Fan oven with ring heating element 		
	Shelf position	Temperature °C	Time in hours: mins.
Pork			

- We only recommend roasting meat and fish **that is more than 1 kg in weight in the oven**.
- To prevent meat juices or fat from burning on to the pan, we recommend putting some liquid in the roasting tin.
- Turn the meat as required (after 1/2 - 2/3 of the cooking time).
- Baste large roasts and poultry with the cooking juices several times during the cooking time. This will give better roasting results.
- Switch the oven off approx. 10 minutes before the end of roasting time to make use of the residual heat.

Food to be roasted	Fan oven with ring heating element 		
	Shelf position	Temperature °C	Time in hours: mins.
shoulder, neck, ham joint (1,000-1,500g)	1	170-190	1:30-2:00
Chops, smoked loin of pork (1,000-1,500g)	1	180-200	1:00-1:30
Meat loaf (750-1,000 g)	1	180-200	0:45-1:00
Knuckle of pork (pre-cooked) (750-1,000g)	1	170-190	1:30-2:00
Beef			
Pot roast (1,000-1,500 g)	1	180-200	2:00-2:30
Roast beef or sirloin, per cm of thickness	1	210-230 ¹⁾	0:06-0:09 min. per cm of thickness
Veal			
Pot roast (1,000-1,500 g)	1	170-190	1:30-2:00
Knuckle of veal (1500-2000 g)	1	170-190	2:00-2:30
Lamb			
Leg of lamb (1,000-1,500 g)	1	170-190	1:15-2:00
Saddle of lamb (1,000-1,500 g)	1	180-200	1:00-1:30
Quick roast items cooked on a baking tray			
Sausages 'Cordon bleu'	1	220-230 ¹⁾	0:05-0:08
Small sausages	1	220-230 ¹⁾	0:12-0:15
Schnitzel or chops, breaded	1	220-230 ¹⁾	0:15-0:20
Rissoles	1	210-220 ¹⁾	0:15-0:20
Fish (steamed)			
Whole fish (1,000-1,500g)	1	210-220	0:45-1:15
Poultry			
Chicken, spring chicken (1-1.5 kg)	1	190-210	0:45-1:15
Chicken half (per 400-500 g)	1	200-220	0:35-0:50
Poultry pieces (per 200-250 g)	1	200-220	0:35-0:50
Duck (1500-2000 g)	1	180-200	1:15-1:45
Game			
Saddle of hare, leg of hare (up to 1,000 g)	1	220-230 ¹⁾	0:25-0:40
Saddle of venison (1,500-2,000 g)	1	210-220	1:15-1:45
Leg of venison (1,500-2,000 g)	1	200-210	1:30-2:15

1) Pre-heat oven

Low temperature cooking

Oven function: Low temperature cooking

With the low temperature cooking oven function the joint becomes beautifully tender and remains particularly succulent.

We recommend low temperature cooking for pieces of tender, lean meat and fish.

Low temperature cooking is not suitable for example for pot roasts or fatty pork roasts. The oven heats up to the pre-set temperature. When this temperature is reached, a signal sounds. After that, the oven automat-

ically switches to a lower temperature to continue cooking.

i With low temperature cooking  **LO** always cook **without a lid**.

1. Sear the meat in a pan over a very high heat.

- Place meat in a roasting dish or directly on the oven shelf with a tray underneath to catch the fat.
- Place in the oven. Select low temperature cooking  **LO**. If necessary change the temperature and cook until done. (See table.).

Low temperature cooking table

Food to be cooked ¹⁾	Weight g	Temperature setting	Shelf position	Total time (mins.).
Roast beef	1000-1500	120	1	90-110
Fillet of beef	1000-1500	120	3	90-110
Roast veal	1000-1500	120	1	100-120
Steak	200 - 300	120	3	20-30

1) Brown in a frying pan before cooking

Grill

Oven function: Grill  **with maximum temperature setting**

Important! Always grill with the oven door closed.

Grilling table

Food to be grilled	Shelf position	Cooking time	
		1st side	2nd side
Slices of white bread ¹⁾	3	4-6 mins.	3-5 mins.
Toasted sandwiches	2	8-10 mins.	---

1) Use the grill shelf without a tray

Fan-assisted grilling

Oven function: Fan-assisted grilling 

Type of dish	Temperature in °C	Tray	Oven shelf	Grilling time in minutes	turn after... minutes.
		Shelf position			
Chicken (900-1,000 g)	180-200	1	2	50-60	25-30
Stuffed rolled pork roast (2,000 g)	180-200	1	2	90-95	45
Pasta bake	180	---	2	30	---
Potato bake au gratin	200	---	2	20-23	---
Gnocchi, au gratin	180	---	2	20-23	---
Cauliflower with Hollandaise sauce	200	---	2	15	---

- Grilling is particularly suitable for flat pieces of meat or fish.
- Normally pre-heat for about 3 minutes to cook flat pieces of meat and fish with the fan-assisted grill. Then put the food to be

grilled in as per the table. Put a baking tray with about 1 - 1.5 cm of water on level 1.

! **Caution!** Hot steam will also escape when the door is opened.

Type of dish	Temperature in °C	Tray Shelf position	Oven shelf	Grilling time in minutes	turn after... minutes.
Rissoles	230	1	3	14-18	6-8
Pork fillet	230	1	2	16-22	6-10
Grilled sausages	230	1	3	14-18	6-8
Fillet steaks, veal steaks	230	1	3	11-13	5-6
Fillet of beef, roast beef (approx. 1 kg)	230	1	2	20-24	10-12

Defrosting

Oven function: Defrosting/Drying

(Temperature setting 30°C)

- Unwrap the food and place it on a plate on the oven shelf.

- Do not cover with a plate or bowl, as these can substantially lengthen the defrosting time.
- For defrosting, place the shelf in the **1st oven level from the bottom**.

Defrosting Table

Dish	Defrosting time (mins.)	Further defrosting time (mins.)	Note
Chicken, 1,000 g	100-140	20-30	Place chicken on an upturned saucer in a large plate. Turn halfway through
Meat, 1,000 g	100-140	20-30	Turn halfway through
Meat, 500 g	90-120	20-30	Turn halfway through
Trout, 150 g	25-35	10-15	---
Strawberries, 300 g	30-40	10-20	---
Butter, 250 g	30-40	10-15	---
Cream, 2 x 200 g	80-100	10-15	Cream can also be whipped when still slightly frozen in places
Gateau, 1400 g	60	60	---

Drying

Oven function: Defrost/Drying

- Use trays covered with greaseproof paper or baking parchment.
- You will get a better result, if you switch the oven off halfway through the drying time,

open the door and leave it to cool down, preferably overnight.
Then finish drying the food to be dried.

Food to be dried	Temperature in °C	Oven level		Time in hours (guideline)
		1 level	2 levels	
Vegetables				
Beans	75	2	2 / 4	6-9
Peppers (slices)	75	2	2 / 4	5-8
Vegetables for soup	75	2	2 / 4	5-6
Mushrooms	50	2	2 / 4	6-9
Herbs	40-50	2	2 / 4	2-4

Food to be dried	Temperature in °C	Oven level	Time in hours (guideline)
Fruit			
Plums	75	2	2 / 4
Apricots	75	2	2 / 4
Apple slices	75	2	2 / 4
Pears	75	2	2 / 4

Making preserves

Oven function: Convection with ring heating element

- When making preserves, only use commercially available preserve jars of the same size.
- **Jars with twist-off or bayonet type lids and metal tins are not suitable.**
- When making preserves, use the **first shelf position from the bottom.**
- Use the baking tray for making preserves. There is enough room on this for up to six 1-litre preserving jars.

- The jars should all be filled to the same level and clamped shut.
- Place the jars on the baking tray in such a way that they are not touching each other.
- Pour approx. 1/2 litre of water into the baking tray so that sufficient moisture is produced in the oven.
- As soon as the liquid in the first jars begins to simmer (with 1--litre jars after about 35-60 minutes), switch off the oven or reduce the temperature to 100°C. (See table.)

Preserves table

Preserves ¹⁾	Temperature in °C	Cooking time until simmering in minutes	Continue to cook at 100 °C (in minutes).
Berries			
Strawberries, blueberries, raspberries, ripe gooseberries	160-170	35-45	---
Unripe gooseberries	160-170	35-45	10-15
Stone fruits			
Pears, quinces, plums	160-170	35-45	10-15
Vegetables			
Carrots ²⁾	160-170	50-60	5-10
Cucumbers	160-170	50-60	---
Mixed pickles	160-170	50-60	15
Kohlrabi, peas, asparagus	160-170	50-60	15-20

1) The times and temperatures for making preserves are for guidance only.

2) Leave standing in oven after switching off

Programmed Functions and Recipes

The appliance has 12 programmed functions/recipes, which can be selected one after the other using the Baking/Roasting Programmes button.

- P 1** CLEANING (cleaning programme)
- P 2** VEGETABLES 500-1,000 G (vegetable platter)

- P 3** POTATO GRATIN
- P 4** WHITE BREAD 500-700 G
- P 5** ROLLS, 40 G each (party rolls, 40g)
- P 6** FISH FILLET (gratinated)
- P 7** TROUT, 250-300 g
- P 8** PIZZA

- P 9** QUICHE LORRAINE
P 10 CHICKEN 1,000 G
P 11 SADDLE OF VEAL 1,000 G
P 12 WARMING UP

CLEANING (cleaning programme)

1. Fill the water (about 150ml) and 1 table-spoon vinegar directly into the steam generator.
2. Using the Baking/Roasting Programmes button, start the automatic cleaning programme.
A triple acoustic signal indicates the end of cleaning programme.
3. Stop the signal and switch off the oven by pressing the On/Off button.
4. Wipe out the oven with a soft cloth.

- Warning!** The oven must have been cooled down.
5. Remove any residual water from the steam generator.
 - Put moist Quick Sponge into cooled down steam generator.

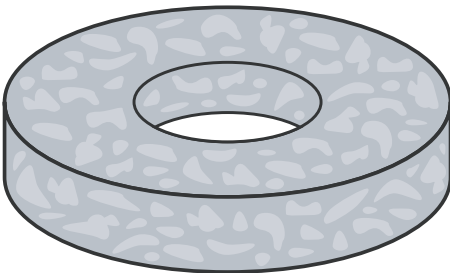

- Soak up well with sponge.
- Remove sponge and squeeze out water.

Leave the door open for approx. 1 hour.

Setting	Oven level
P 1 CLEANING	---
Cook Time	Water to add via water drawer
15 min.	150 ml

VEGETABLES 500-1,000 G (vegetable platter)

Cookware:

Any kind of cookware that is heat-resistant to at least 100°C can be used.

Ingredients:

- 400 g cauliflower
- 200 g carrots
- 200 g kohlrabi
- 200 g yellow and red peppers

Preparation:

Rinse cauliflower and divide into florets.

Peel carrots and kohlrabi and cut into bite-sized pieces.

Wash the peppers and cut into strips. Place all vegetables into an open oven dish and cook without adding water. It is possible to do without salt and other seasonings with this method of cooking.

Setting	Oven level
P 2 VEGETABLES 500-1000 G	1 and 4
Cook Time	Water to add via water drawer
40 min.	650 ml

POTATO GRATIN (serves 4-5)

Preparation:

Grease Pyrex dish, 30 x 21 cm, with butter.

Ingredients:

- 1,000 g potatoes
- 60 g grated cheese
- 200 ml cream
- 200 ml milk
- Salt, pepper, nutmeg, garlic

Preparation:

Peel potatoes, cut into approx 3 mm thick slices and layer them in a gratin dish. Season with salt, pepper, nutmeg and garlic.

Mix milk and cream and pour over the potatoes. Finally sprinkle the grated cheese over the top.

Setting	Oven level
P 3 POTATO GRATIN	2
Cook Time	Water to add via water drawer
50 min.	200 ml

WHITE BREAD 500-700 G

Ingredients:

- 1000 g flour, type 405
- 1 cube of fresh yeast or 2 packets of dried yeast
- 600 ml milk
- 15 g salt

Preparation:

Place flour and salt in a large bowl. Dissolve the yeast in tepid milk and add to the flour. Knead all ingredients into a workable dough. More milk may be required, depending on the texture of the flour.

Leave the dough to rise until it doubles in volume.

Shape two loaves out of the dough and place them on the greased baking tray or patisserie tray (special accessory). Leave the loaves to rise again by half their volume.

Before baking, dust them with a little flour and use a sharp knife to cut 3 diagonal lines, at least 1 cm deep.

Setting**Oven level**

P 4 WHITE BREAD 2
500-700 G

Cook Time**Water to add via water drawer**

55 min.

200 ml

ROLLS, 40 G each (party rolls, 40g)**Ingredients:**

- 500 g flour, type 405
- 20 g cube of fresh yeast or 1 packet of dried yeast
- 300 ml water
- 10 g salt

Preparation:

Place flour and salt in a large bowl. Dissolve the yeast in the water and add to the flour. Knead all ingredients into a workable dough. Leave the dough to rise until it doubles in volume.

Cut the dough into pieces, form into rolls and place on the greased baking tray or patisserie tray (special accessory). Leave rolls to rise again for approx. 25 minutes.

Before baking, cut a cross in the rolls. Sprinkle with poppy, caraway or sesame seeds, if desired.

Setting**Oven level**

P 5 ROLLS, 40 G EACH 3

Cook Time**Water to add via water drawer**

15 min.

200 ml

FISH FILLET (700g)**Ingredients:**

- 700 g pike-perch fillet or sea trout fillet, cubed
- 100 g Emmental cheese, grated
- 200 ml cream
- 50 g breadcrumbs
- Salt, pepper, lemon juice
- Parsley, chopped
- 40 g butter to grease the dish

Preparation:

Sprinkle the fish fillet with lemon juice and leave it to marinate for a while. Then dab off surplus juice using kitchen paper.

Then season the fish fillet on both sides with salt and pepper. Then place in a greased oven-proof dish.

Mix the cream, grated cheese, breadcrumbs and the chopped parsley and spread over the fish.

Setting**Oven level**

P 6 FISH FILLET 2

Cook Time**Water to add via water drawer**

25 min.

250 ml

TROUT, 250-300 g**Ingredients:**

- 4 trout à 250 - 300 g
- Lemon juice, pepper, salt

Preparation:

Wash the trout well inside and out, sprinkle with lemon juice, season and place in a stainless steel dish with perforated insert (special accessory), with 2 trout per dish.

Serve with toasted flaked almonds.

Steamed trout variation:

Before the trout are placed in the stainless steel dish with perforated insert, pour hot water and vinegar over them.

Setting**Oven level**

P 7 TROUT 2
250-300 G

Cook Time**Water to add via water drawer**

30 min.

400 ml

PIZZA (4, approx. 28cm in diameter)**Preparation:**

Tomato sauce

Ingredients for the pastry:

- 500 g flour, type 405
- 250 ml water

- 20 g yeast
- 1 egg
- 2 tbsp olive oil
- 1 tsp salt

Method for the dough:

Dissolve the yeast in the water and knead into a soft dough with the other ingredients. Leave dough covered for 30 minutes, deflate three times during this time.

Ingredients for the tomato sauce:

- 2 tins peeled, chopped tomatoes (800 g)
- 100 g onions, finely chopped
- 2 cloves of garlic, finely chopped
- Salt, pepper, oregano or pizza herbs

Method for the tomato sauce:

Mix onions, garlic, seasoning and herbs into the tomatoes and reduce the liquid, until a thick sauce is produced. Leave to cool.

Ingredients for the topping:

600 g pizza cheese (feta), coarsely grated, per pizza 150 g

Toppings 400 g:

Ham, salami, mushrooms, diced bacon, anchovies, per pizza 100 g

Finishing:

Divide the dough into 4 portions, shape into rounds and roll them out using a lot of flour into bases approx 3-4 mm in thickness.

Spread the bases with cold tomato sauce, leaving about 1 cm at the edge. Cover with your desired toppings and pizza cheese.

Bake with pre-heating, 230°C

Setting	Oven level
P 8 PIZZA	3
Cook Time	Water to add via water drawer
25 min.	---

QUICHE LORRAINE

Ingredients for the pastry:

250 g flour, type 405

125 g butter

60 ml water

1 tsp salt

A little pepper and nutmeg

Preparation:

Mix together flour, butter and salt, add the water and knead together briefly to form a pastry.

Leave the pastry to rest in the fridge for 1 hour.

Ingredients for the topping:

- 100 ml milk
- 150 ml sour cream
- 2 eggs
- 150 g Gruyère or Emmental cheese, grated
- 150 g lean ham, diced
- 150 g onions, diced
- Pepper, nutmeg

Preparation:

Lightly sauté the bacon and onions.

Whisk the milk, cream, eggs and seasoning together well, then mix in the cheese.

Finishing:

Roll out the pastry and lay it in a greased plain springform tin (dia. 28cm). Distribute the bacon and onions evenly over the pastry and pour over the liquid mixture.

Setting	Oven level
P 9 QUICHE LORRAINE	3
Cook Time	Water to add via water drawer
35Min.	---

CHICKEN 1200 G

Ingredients:

- 1 chicken (1,000 - 1,200 g)
- 2 tbsp peanut oil
- Salt, pepper, paprika and curry powder

Preparation:

Wash the chicken and dry it with kitchen paper.

Mix the spices with the oil and use the mixture to coat the chicken evenly inside and out.

Then place the chicken, breast-side down, in an ovenproof dish or glass dish with perforated insert (special accessory).

After approx. 25 minutes, turn the chicken.

After the first acoustic signal (approx. 50 min.), check how the meat is cooking. If necessary, leave it to cook for the remaining roasting time until the second acoustic signal (approx. 60 min.) sounds.

Setting	Oven level
P 10 CHICKEN 1200 G	2
Cook Time	Water to add via water drawer

55 min. 200 ml

SADDLE OF VEAL (serves 4-6)**Preparation:**

Take meat out of the fridge 1 hour beforehand.

Ingredients:

- 1,000 g saddle of veal
- 2 tbsp peanut oil
- Salt, pepper, paprika and a little mustard

Preparation:

Wash the saddle of veal and dry it with kitchen paper.

Mix the seasoning with the peanut oil and use the mixture to coat the meat evenly.

Sear the saddle of veal in a frying pan on the cooker over a very high heat on all sides for 10 minutes and place it in the pre-warmed tin

Baking tin:

Heat-resistant glass dish, ceramic dish or cast iron roasting pan.

Setting	Oven level
----------------	-------------------

P 11 SADDLE OF VEAL	2
----------------------------	----------

Cook Time	Water to add via water drawer
------------------	--------------------------------------

80 min.	200 ml
---------	--------

"WARMING UP" (dishes to serve 4-6)**Cookware:**

Any kind of cookware that is heat-resistant to at least 110 °C can be used.

Preparation:

Arrange the foods individually or together on the plate or cookware. Place in the oven without a cover.

max. 6 plates (dia. 26 cm).

Setting	Oven level
----------------	-------------------

P 12 WARMING UP	1 and 4
------------------------	----------------

Cook Time	Water to add via water drawer
------------------	--------------------------------------

20 min.	200 ml
---------	--------

Cleaning and servicing

 **Warning!** For cleaning, the appliance must be switched off and cooled down.

 **Warning!** For safety reasons, do not clean the appliance with steam jet or high-pressure cleaning equipment!

 **Caution!** Do not use any scouring agents, sharp cleaning tools or scourers.

 **Caution!** Do not use any rough, polishing cleaners or sharp metal scrapers to clean the glass that can scratch the surface, as this can cause the glass to break.

The outside of the appliance

- Wipe down the front of the appliance with a soft cloth and a solution of hot water and washing-up liquid.
- For metal fronts, use normal commercially available cleaning agents.
- Please do not use any scouring agents or abrasive sponges.

Oven interior**Cleaning programme**

The function CLEANING is described in detail in the section Programmed Functions and Recipes.

Manual cleaning

 **Warning!** The oven must have cooled down before cleaning.

 Clean the oven after every use. This is the easiest way to remove dirt which then cannot burn itself into the oven.

1. When the oven door is opened, the oven light switches itself on automatically.
2. Wipe out the oven after every use with a solution of water and washing-up liquid and then dry it. Do not use any abrasive objects! If necessary, soak dirt first or briefly switch on the Steam Cooking function.

 Remove stubborn dirt with special oven cleaners.

 **Caution!** When using oven sprays, please follow the manufacturer's instructions exactly!

Accessories

Wash up all insertable parts (oven shelf, baking tray, side rails, etc.) after each use and dry well. For easier cleaning, leave to soak for a while.

Shelf support rails

The left and right hand side rails can be removed from the oven so that the side walls can be cleaned.

Removing the shelf support rails

1. Carefully pull the rail up and out of the front catch.

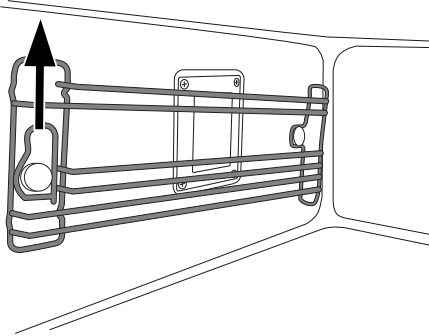

2. Gently swing the rail on the front catch inwards.

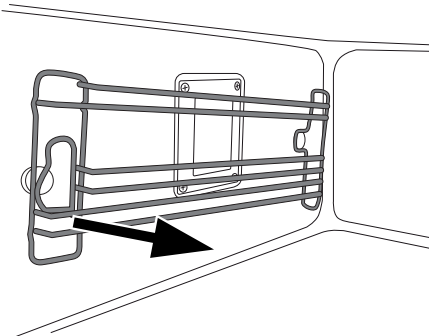

3. Pull the rail out of the rear catch.

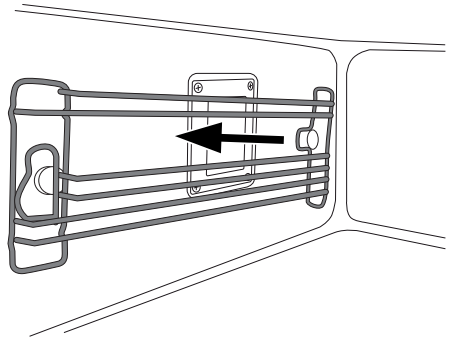

Inserting the side rail

1. Insert the rail at an angle from above and along the side wall into the rear catch.

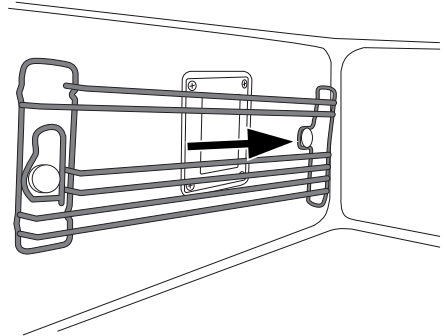

2. Swing the rail on the front catch above the bolts towards the wall.

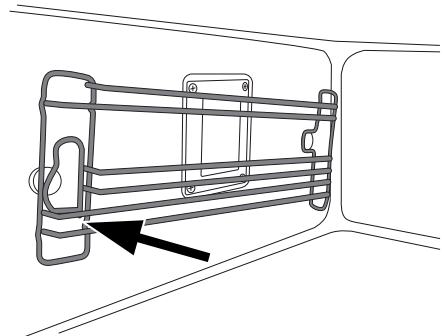

3. Insert the rail into the front catch.

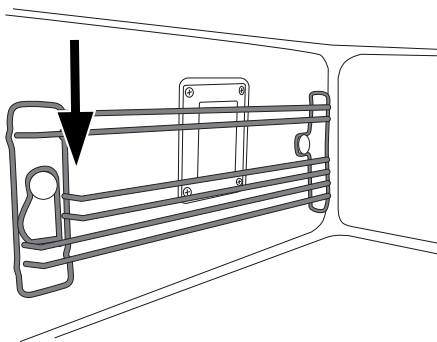

Steam generation system

Important! Wipe the steam generator dry after each use. Soak up water with a sponge.

i Remove any lime residue with water and vinegar.

Important! Chemical de-scaling agents may damage the oven's surface enamel. Please follow the manufacturer's instructions exactly.

Water drawer and steam generator

1. Pour the water and vinegar mixture (approx. 250 ml) into the steam generator **via the water drawer**.

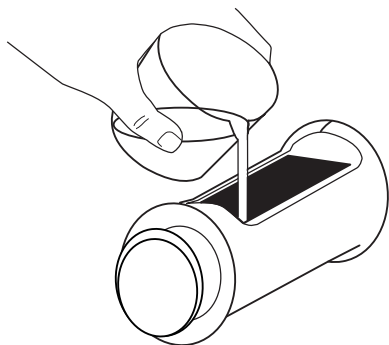

Leave to work for about 10 minutes.

2. Remove the water and vinegar with a non-abrasive sponge.
3. Rinse out the steam generation system **through the water drawer** using clean water (100-200 ml)

4. Remove water from the steam generator with the sponge and wipe dry.
5. Leave the door open to let the oven dry completely.

Oven light

! **Warning!** Risk of electric shock! Before replacing the oven light bulb:

- Switch off the oven!
- Take the fuses out of the fuse box or switch off.

i To protect the oven light bulb and the glass cover lay a cloth on the floor of the oven.

Replacing the side oven light bulb/ cleaning the glass cover

1. Take out the side rail on the left.
2. Unscrew the screws from the metal frame using a cross-tip screwdriver.

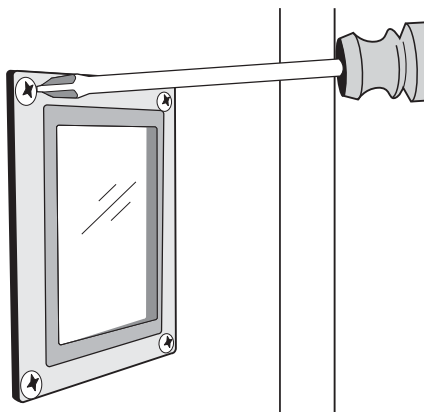

3. Take off the metal frame and seal and clean.
4. If necessary: replace bulb with a 25 Watt, 230 V, 300°C heat-resistant oven light bulb.
5. Re-fit metal frame and seal and tighten screws.

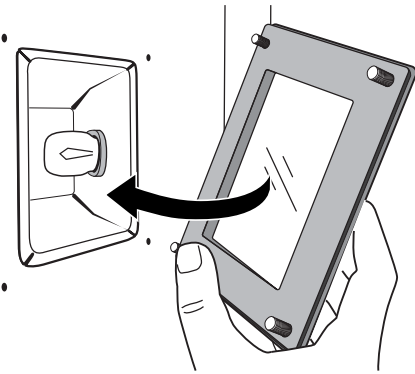

6. Insert the side rail.

Oven door

The oven door of your appliance can be taken off its hinges for cleaning.

Removing the oven door from its hinges

1. Open the oven door as far as it will go.
2. Fold back the clamping levers **on both door hinges** completely
3. Take hold of the oven door on the sides with both hands and close it about 3/4 of the way through the point of resistance

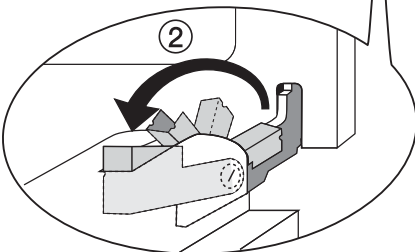
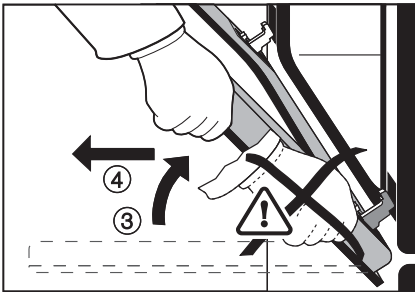

4. Pull the oven door away **Caution:** it is heavy!
5. Lay the door with the outer side facing downwards on something soft and level, for example, a blanket, in order to prevent scratches.

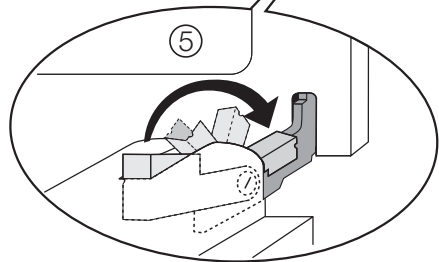
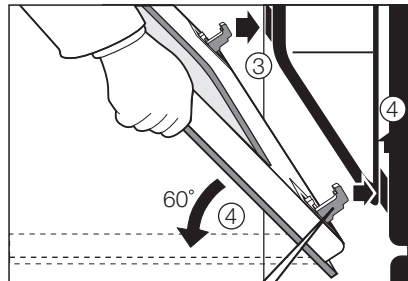

Hanging the oven door back on its hinges

1. With the face of the door with the handle on it towards you, take hold of the sides of the door with both hands.
2. Hold the door at an angle of approx. 60°.
3. Push the door hinges **at the same time** into the two recesses at the bottom of the oven on the left and the right as far as they will go.
4. Lift the door up to the point of resistance and then open it completely.





5. Fold the clamping levers on both door hinges back into their original positions.
6. Close the oven door.

What to do if ...

Problem	Possible Cause	Remedy
The oven is not heating up	The oven has not been switched on	Switch the oven on
	The clock has not been set	Set the current time on the clock
	The required settings have not been set	Check the settings
	The oven's automatic switch-off has been triggered	See Automatic switch-off
	The child lock is switched on	Switching off the child safety device
The oven lighting is not operating	The oven light bulb is faulty	Replace oven light bulb
	"d" appears on the display and the oven does not heat up in any mode.	Switch the appliance off, hold down  and  at the same time until the signal sounds and the "d" on the display goes out.

If you are unable to remedy the problem by following the above suggestions, please contact your dealer or the Customer Care Department.

 **Warning!** Repairs to the appliance are only to be carried out by qualified service engineers. Considerable danger to the user may result from improper repairs.

 If the appliance has been wrongly operated, the visit from the customer service

technician or dealer may not take place free of charge, even during the warranty period.

 Advice on cookers with metal fronts: Because of the cold surface at the front of the cooker, opening the oven door during (or just after) baking or roasting may cause the glass to steam up.

Installation Instructions

 **Caution!** The new appliance may only be installed and connected by a registered installation engineer. Please comply with this instruction. If you do not, any damage resulting is not covered by the warranty.

To prevent future hazards, damaged mains cables must only be replaced by a qualified electrician.

Safety information for the installer

- The set-up of the electrical installation is arranged so that the appliance can be isolated from the mains with a minimum 3mm all-pole contact separation.

Suitable separation devices include e. g. cut-outs, fuses (screw fuses are to be taken out of the holder), RCD's and contactors.

- The site must provide a connection to the electrical supply by means of a socket that is accessible and outside the coordination space.
- Anti-shock protection must be provided by the installation.
- The built-in unit must meet the stability requirements of DIN 68930.

1a

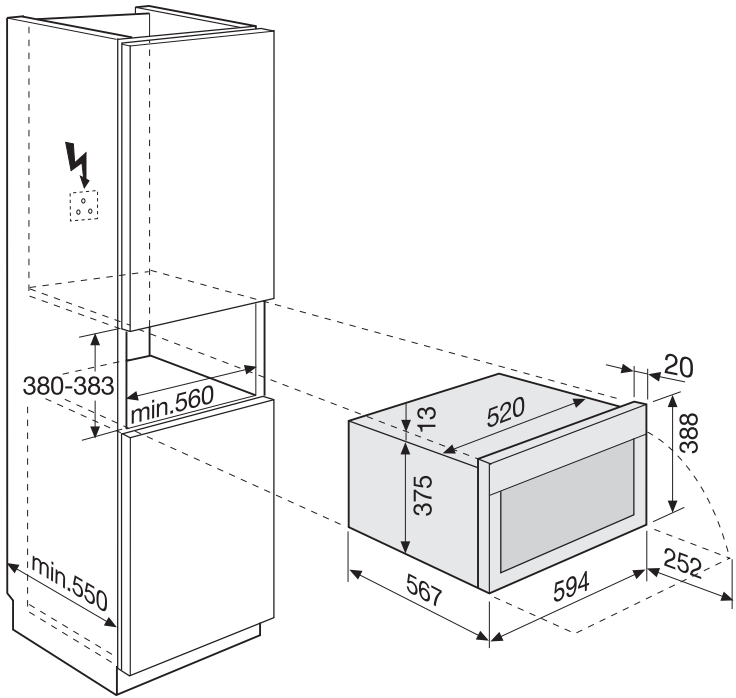

1b

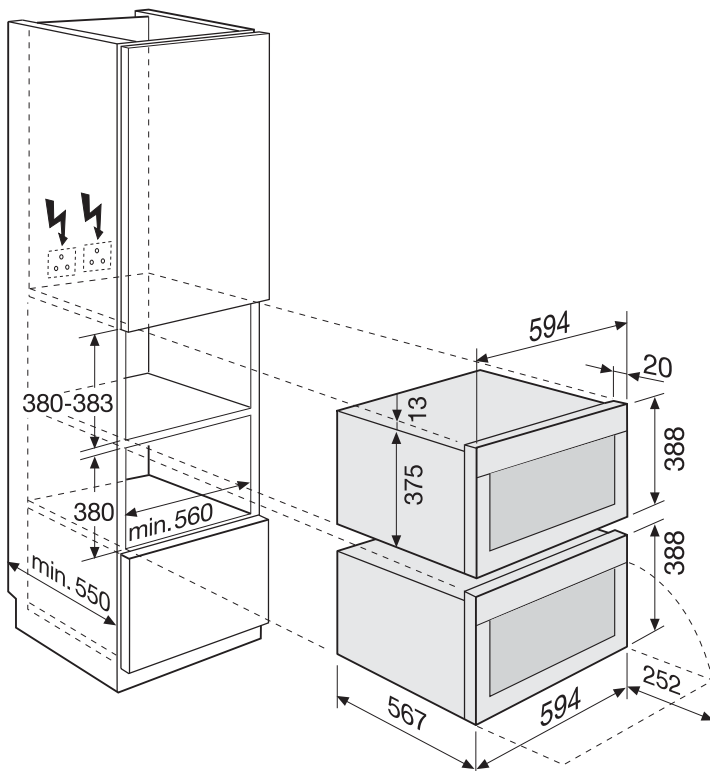

1c

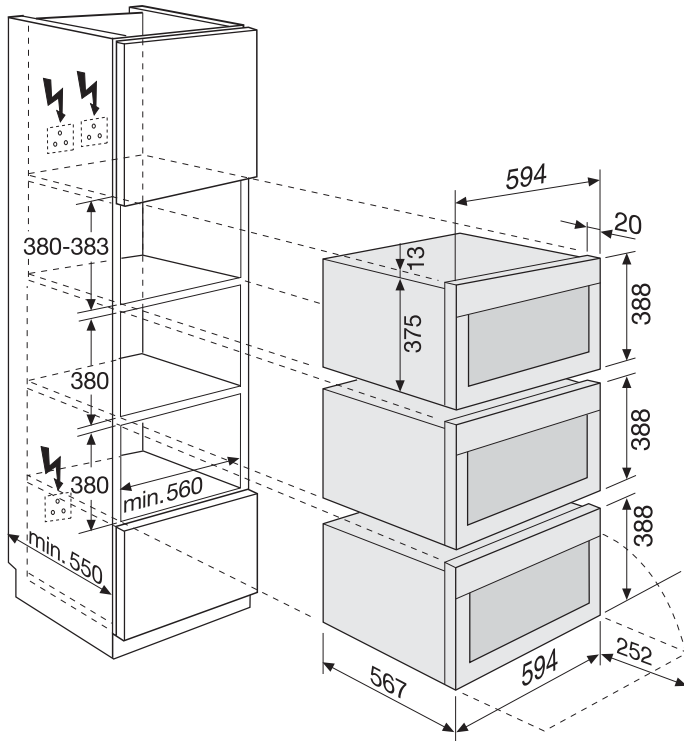

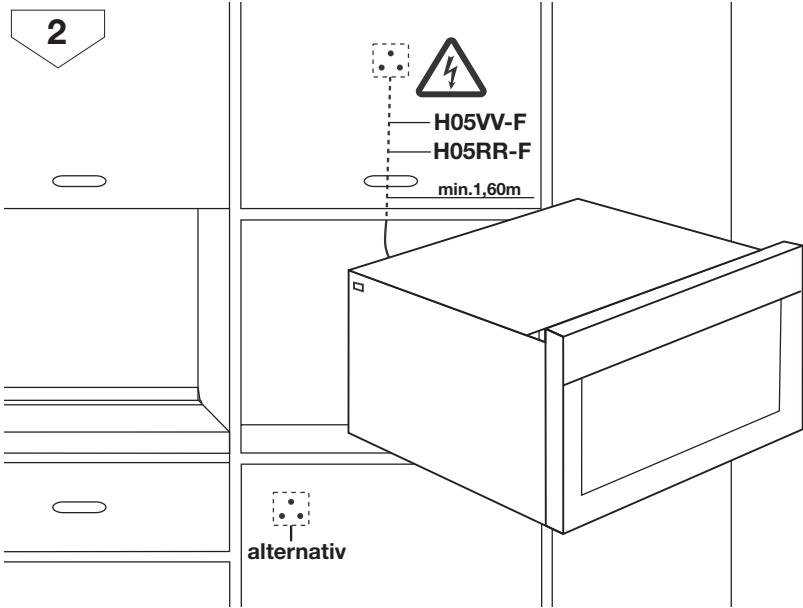

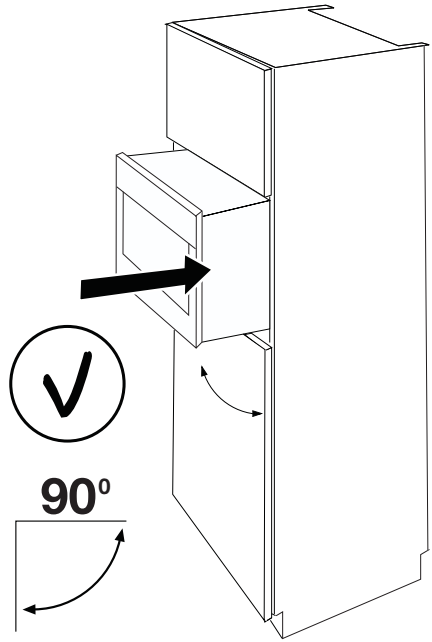
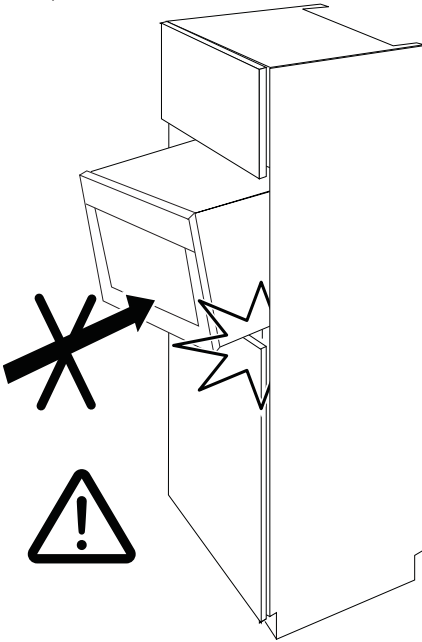

3

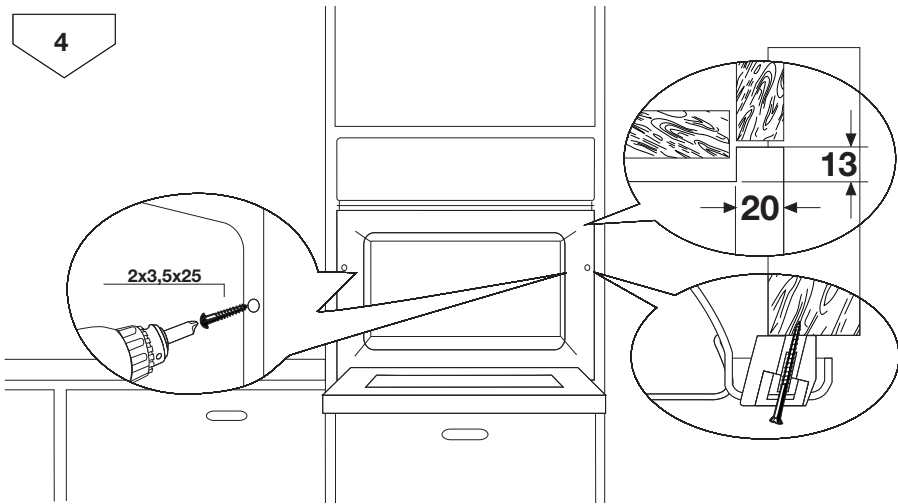



Disposal

The symbol  on the product or on its packaging indicates that this product may not be treated as household waste. Instead it should be taken to the appropriate collection point for the recycling of electrical and electronic equipment. By ensuring this product is disposed of correctly, you will help prevent potential negative consequences for the environment and human health, which could otherwise be caused by inappropriate waste handling of this product. For more detailed information about recycling of this product, please contact your local council, your household waste disposal service or the shop where you purchased the product.

 Packaging material

The packaging material is environmentally-friendly and recyclable. Plastic parts are marked with international abbreviations such as PE, PS, etc. Dispose of the packaging material in the containers provided for this purpose at your local waste management facility.

 **Warning!** Your appliance should be made inoperable before it is disposed of, so that it does not constitute a danger. To do this, take the mains plug from the socket and remove the mains cable from the appliance.

Service

In the event of technical faults, please first check whether you can remedy the problem yourself with the help of the operating instructions (section "What to do if...") If you were not able to remedy the problem yourself, please contact the Customer Serv-

ice Department or one of our service partners.

In order to be able to assist you quickly, we require the following information:

- Model description
- Product number (PNC)

- Serial number (S-No.) (for numbers, see rating plate)
- Type of fault
- Any error message displayed by the appliance

So that you have the necessary reference numbers from your appliance at hand, we recommend that you write them in here:

Model descrip-

tion:

PNC:

S-No:

www.electrolux.com

To buy accessories, consumables and spare parts at our online shop please visit:
www.electrolux.co.uk