

C e r a m i c g l a s s i n d u c t i o n h o b

Installation and Operating Instructions

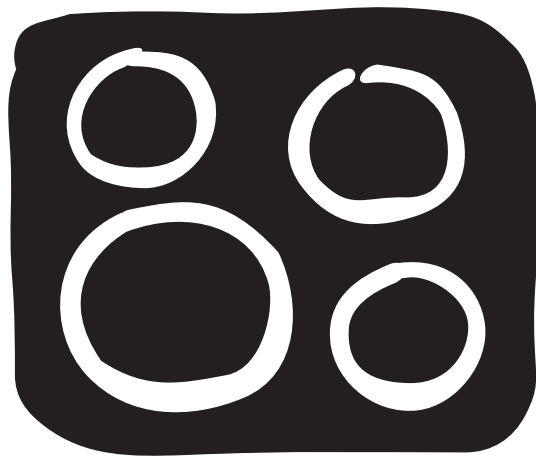

EHD 8680 X / EHD 8680 U

Dear customer,

Please read these operating instructions carefully. Pay particular attention to the section “Safety information” on the first few pages. Please retain these operating instructions for later reference. Pass them on to possible new owners of the appliance.

The following symbols are used in the text:



Safety instructions

Warning: Information concerning your personal safety.

Important: Information on how to avoid damaging the appliance.



Information and practical tips



Environmental information

1. These numbers indicate step by step how to use the appliance.

2. ...

3. ...

These operating instructions contain information on steps you can take yourself to rectify a possible malfunction. Refer to the section “What to do if...”.

Contents

Operating Instructions	4
Safety	4
Disposal	6
The Key Features of Your Appliance	7
Description of the Appliance	8
Cooking zones and control panel	8
The Digital Displays	9
Cooking Zone Safety Cut-out	10
Function and the Way the Induction Cooking Zone Works	10
Suitable Kitchenware for Induction Cooking Zones	11
Before Using for the First Time	12
Initial Cleaning	12
Operating the Hob	12
Touch Control Sensor Field	12
Switching On the Appliance	12
Switching Off the Appliance	12
Cooking Zone Selection	13
Heat Setting Selection	13
Activating the Power Function	14
Switching off a Cooking Zone	14
Cooking with the Automatic Heating-Up Function	15
Cooking without the Automatic Heating-Up Function	16
Residual Heat Indicator	16
Locking/Unlocking the Control Panel	17
Timer	18
Uses, Tables and Tips	20
Advice on Cooking with and without Automatic Warm up	20
Chart for Setting the Cooking Zones	21
Chart for the Automatic Heating-Up Feature	22
Cleaning and Care	23
Advantages for Cleaning and Caring for the Induction Cooking Zone	23
Hob	23
Hob Frame	24
What to do if	25
Rectifying faults	25
Installation Instructions	26
Technical Data	26
Regulations, Standards, Directives	26
Safety Instructions for the Installer	27
Electrical Connection	28
Rating Plate	28
Guarantee Conditions	29
Service	31
Assembly	33

Operating Instructions

Safety

The safety aspects of this appliance comply with accepted technical standards and the German Appliance Safety Law. However, as manufacturers we also believe it is our responsibility to familiarise you with the following safety instructions.

Electrical Safety

- The installation and connection of the new appliance must only be carried out by qualified personnel.
- Repairs to the appliance are only to be carried out by approved service engineers. Repairs carried out by inexperienced persons may cause injury or serious malfunctioning. If your appliance needs repairing, please contact your local customer center or your dealer.

 Please follow these instructions, otherwise the warranty will not cover any damage that may occur.

- Flush-mounted appliances may only be operated following installation in suitable installation cabinets and workplaces which conform to the relevant standards. This ensures sufficient protection against contact for electrical units as required by the VDE [Association of German Electrical Engineers].
- If your appliance malfunctions or if fractures, cracks or splits appear:
 - switch off all cooking zones,
 - disconnect the hob from the electricity supply.

Child Safety

The cooking zones will become hot when you cook. Therefore, always keep small children away from the appliance.

The appliance is not intended for use by young children or infirm persons without supervision.

Young children should be supervised to ensure that they do not play with the appliance.

Safety During Use

- This appliance may only be used for normal cooking and frying in the home. It is not designed for commercial or industrial purposes.
- Do not use the hob to heat the room.
- Take care when plugging electric appliances into mains sockets near the hob. Connection leads must not come into contact with the hot surface.

- Overheated fats and oils catch fire quickly. You should supervise cooking when preparing foods in fat or oil (e.g. chips).
- Switch off the cooking zones after use.

Special Notes on Induction Cooking Zones

- Scientific studies have shown that patients who are fitted with implanted pacemakers are not normally affected or put at risk by our induction cooking zones.
The distance between the body and the cooking zone should, however, never be less than 30 cm!
- Electromagnetic fields can affect electronic circuits and interfere with portable transistor radios.
- Do not put magnetically rechargeable objects (e.g., credit cards, cassettes) on the glass ceramic surface while one or more induction cooking zones are in use!
- Do not put any metallic objects (e.g., spoons, pan lids) on the induction surface as they can be warmed up when the induction surface is in use.

 Some cookware can produce noises when used on induction cooking zones. This is not a fault in the hob and its function will not be impaired in any way as a result.

Safety When Cleaning

- For safety reasons do not clean the appliance with a steam jet or high pressure cleaner.
- Clean the hob in accordance with the maintenance and cleaning instructions in this manual.

To Avoid Damaging Your Appliance

- Do not use the hob as a work surface or for storage.
- Do not operate the cooking zones when there is no pan or the pans are empty.
- Ceramic glass is insensitive to temperature shock and very robust; however it is not unbreakable. Especially sharp and hard objects that fall on the cooking surface can damage it.
- Do not use cast iron pans or pans with a rough, burred or damaged base. Scratching may occur if the pans are slid across the surface.
- Do not place any pans on the hob frame. Scratching and damage to the paint may occur.
- Make sure that no acidic liquids, e.g. vinegar, lemon or descaling agents, are spilt onto the hob frame, since these cause dull spots.
- If sugar or a preparation with sugar comes into contact with the hot cooking zone and melts there it must be cleaned off immediately with a scraper while it is still hot. If it cools, the surface may be damaged when it is removed.
- Keep all items and materials that can melt away from the ceramic glass surface, e.g. plastics, aluminium foil, or oven foils. If something of this nature should melt onto the ceramic glass surface, it must also be removed immediately using the scraper.

Disposal

Disposing of the packaging material

All materials used can be fully recycled.

Plastics are marked as follows:

- >PE< for polyethylene, as used for the outer wrapping and the bags inside.
- >PS< for polystyrene foam, e.g., as used for the padding materials. They are completely free of CFCs.

Disposal of old appliances



Warning: Before disposing of old appliances please make them inoperable so that they cannot be the source of danger.

To do this, disconnect the appliance from the mains supply and remove the mains lead.

To protect the environment, it is important that worn out appliances are disposed of in the correct manner.

- The appliance must not be disposed of with household rubbish.
- You can obtain information about collection dates or public refuse disposal sites from your local refuse department or council.

The Key Features of Your Appliance

- **Induction cooking zones:** The appliance is fitted with a ceramic glass hob and induction cooking zones. Induction heats the base of the pan immediately and does not heat the ceramic glass hob first.
- **Sensor fields:** Your appliance is operated using Touch Control sensor fields.
- **Cleaning:** The advantage of the ceramic glass cooking surface and the sensor fields is their accessibility for cleaning. The smooth, flat surface is easy to clean.
- **On/Off sensor field:** The “On/Off” sensor field provides the appliance with a separate mains switch. Touching this switches the power supply on or off completely.
- **Sensor field lock:** With this device the operating panel can be locked, for example as a safety precaution for children.
- **Control and function indicators:** Digital indicators or control lamp provide information about settings made, functions activated, as well as any residual heat of the corresponding cooking zone.
- **Safety cut-out:** A safety cut-out ensures that all cooking zones switch off automatically after a period of time if the setting has not been changed.
- **Power device:** With this device the power for the appropriate cooking rings can be temporarily increased.
- **Keep warm setting:** is the setting for keeping foods warm.
- **Residual heat indicator:** An for residual heat is shown in the display if the cooking zone becomes so hot that there is a risk of burning.
- **Timer:** All zones can be automatically switched off using the integrated timer. When the end of the cooking time has been reached, the cooking zone switches off.

Description of the Appliance

Cooking zones and control panel

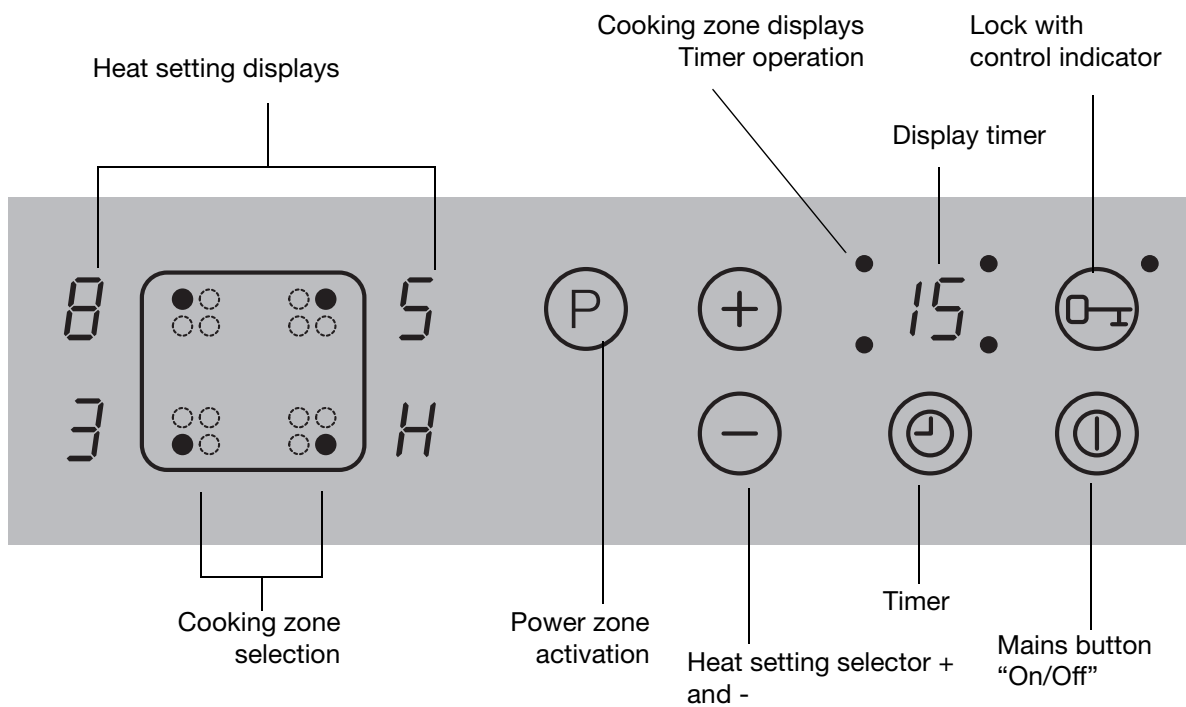
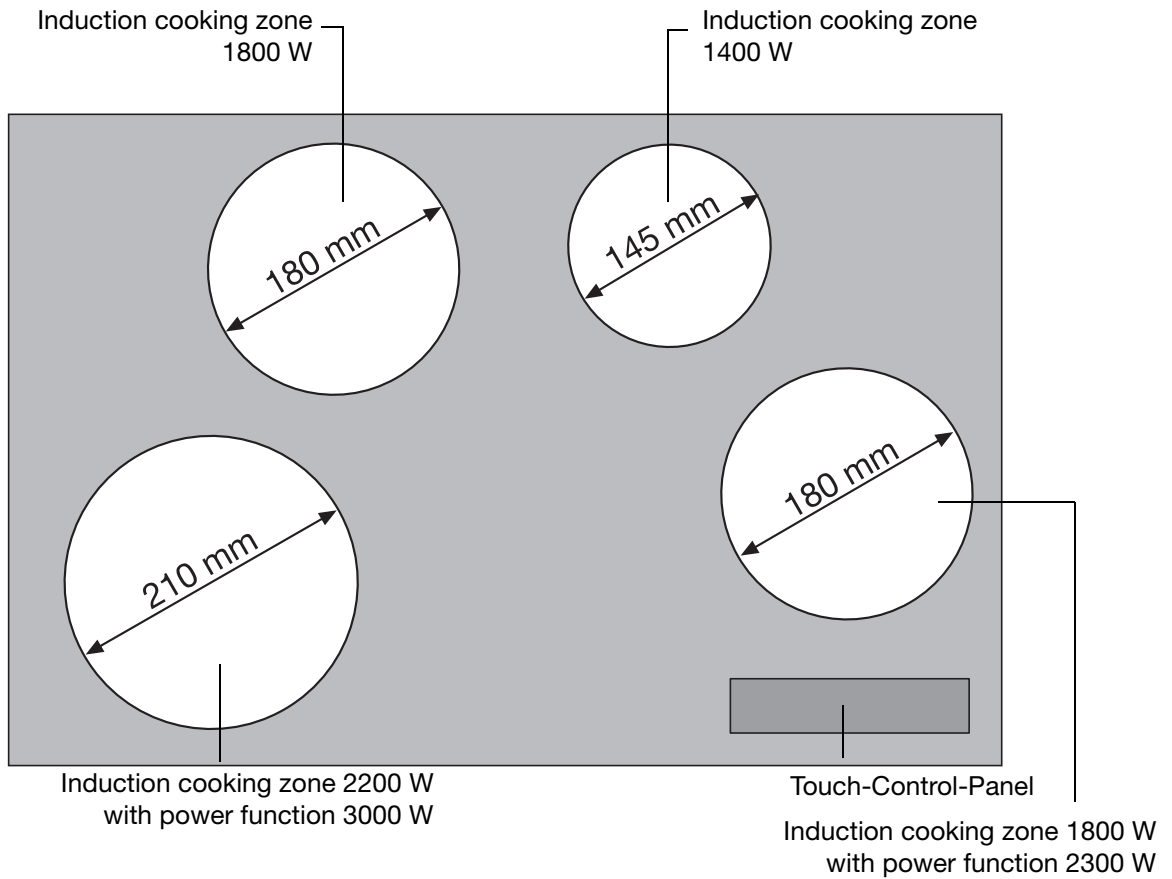

The Digital Displays

Digits 1 to 9 and four different letters can appear in the display.

- The digits show the cooking stage set.

L = **Lowest capacity**

9 = **Highest capacity**

P = **Power level**

- The following letters and functions are displayed for the cooking zones:



H = **Residual Heat Display**

Danger! Cooking zone still hot; it extinguishes when the cooking zone has cooled down. This display appears only if the cooking zone is switched off.

R = **Automatic heating-up (possible for all cooking zones)**

is lit, if the cooking zone is set to automatic heating-up; (remains lit until the automatic feature switches over to the set continued cooking stage).

A = Lights up when the automatic switch-off function has been activated (also see “What to do if ...?”).



F = **Error display**

flashes if the cooking zone is activated and



- no pan is on the cooking zone or
- unsuitable pots and pans are used

P = **Power function**

lights up when the Power function is activated. The Power function supplies extra-high heating capacity. It can be activated for the front two cooking zones.

Cooking Zone Safety Cut-out

If one of the cooking zones is not switched off after a certain time or if the heat setting is not changed, the corresponding cooking zone switches itself off automatically.

 appears in the ring display for all rings that are switched on, and  after they have cooled down.

The rings are switched off at:

- Heat setting 1 - 2 after 6 hours
- Heat setting 3 - 4 after 5 hours
- Heat setting 5 after 4 hours
- Heat setting 6 - 9 after 1.5 hours

 If one or more cooking zones switch off before the times indicated see section “What to do if ...”.

Cancelling the Safety Cut-out

To cancel the activated safety cut-out the appliance must be switched off and then on again using the ON/OFF  sensor field. After this the cooking zones are again ready for use.

Switching Off for Other Reasons

Liquid that boils over onto the control panel causes all cooking zones to switch off immediately.

If you place a wet cloth on the control panel it has the same effect. In both cases the appliance has to be switched on again using the mains switch  after removing the liquid or cloth.

Function and the Way the Induction Cooking Zone Works

A copper wire induction coil is beneath the ceramic glass cooking surface. This generates electromagnetic fields, which act directly on the base of the pots and pans and not, as with other heating up methods, first heating the ceramic glass. This means that **the base of the pan is immediately heated up, which saves time and energy.**

Since the heat required for cooking is generated directly in the base of the pan the cooking zone itself hardly warms up. It only receives the reflected heat from the pan base.

Note:

If there is no pot or pan on the cooking zone there is no energy transfer (heating up) and therefore gives protection against the cooking zones being switched on accidentally.

 A cooling fan is an integral part of this hob and comes on automatically depending on the temperature of the induction cooking zone. The cooling fan works in two speed levels depending on usage. The cooling fan will continue to run for a short period after the cooking zone has been switched off.

Suitable Kitchenware for Induction Cooking Zones

Pots and Pans

- In principle all pots and pans with magnetic bases are suitable. These are steel, steel-enamel as well as cast-iron pots and pans.
- High grade steel pans with a mixed metal base (sandwich base, e.g. Tefal with an aluminium/copper base) are suitable for induction only if the manufacturer has expressly marked them as such. In that case they have a ferromagnetic percentage in the base.
- If you wish to use a special type of pan (e.g. a pressure cooker, simmering pan, wok, etc.), please observe the manufacturer's instructions.
- Aluminium, copper, brass, stainless steel pots and pans (unless specifically designated as suitable for induction), glass, ceramic or porcelain are not suitable for induction cooking zones. The cooking zone reacts as if it were being used without a pot or pan: Error code **F**.

Look for the label: Suitable for induction!

Suitability Test

If you are not sure if a pot or pan is suitable for cooking or frying on the induction cooking zone you can check this as follows:

- Place a pot filled with a little water (3-5 mm filling height) on the cooking zone.
Switch the cooking zone to full power (switch setting 9).
Caution: The pan base of suitable kitchenware heats up within a few seconds!
- You can also check this with a magnet. If it remains fixed to the base the pan is suitable for induction cooking zones.

Pan Size

Up to a certain limit the induction cooking zone adapts itself to the size of the pan base diameter. However, the pan base diameter must be of a minimum size, depending on the size of the cooking zone.

Diameter of the cooking zone 14,5 cm:

Diameter of the pan base at least **12 cm**

Diameter of the cooking zone 18 cm:

Diameter of the pan base at least **14,5 cm**

Diameter of the cooking zone 21 cm:

Diameter of the pan base at least **18 cm**

Note:

Please note the **diameter of the pan base** when buying new pans, since the manufacturers usually specify the top edge diameter of their pans.

Automatic Pan Sensing

The induction cooking zone does not function when unsuitable pans are used.

If the cooking zone is switched on without a suitable pan on it **F flashes in the digital display of the cooking zone.**

After about 10 minutes the cooking zone switches itself off automatically. **F** appears in the digital display.

Also when overheating occurs (e.g. heating up a pan that is empty) or with faults in the electronics the display **F** is lit. The cooking zone switches itself off automatically.

To be able to use it again the cooking zone must have been first switched off and then reset to the required heat setting.

Before Using for the First Time

Initial Cleaning

Wipe the ceramic glass surface with a damp cloth.

 **Important:** Do not use any caustic, abrasive cleaners! The surface could be damaged.

Operating the Hob

Touch Control Sensor Field

To operate the Touch Control sensor field place your finger from above flat onto the required field until the appropriate displays come on or go out or the required function is carried out.

Switching On the Appliance

The entire appliance is switched on using the “On/Off”  sensor field.

Touch the “On/Off” sensor field for approx. 2 seconds.

The digital displays will show  and the decimal point will flash.

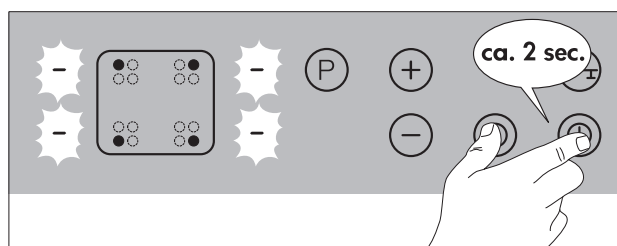

 Once the “On/Off” sensor field has been operated to switch on the appliance, one of the cooking zones must be selected within approx. 10 seconds using the cooking zone selection buttons. Otherwise the appliance switches off again for safety reasons.



Switching Off the Appliance

To switch off the appliance completely activate the “On/Off”  sensor field.

Touch the “On/Off” sensor field for approx. 1 second.

 When an individual cooking zone or the entire hob is switched off, any residual heat is shown with an  (for “Hot”) in the digital display for the appropriate cooking zones.

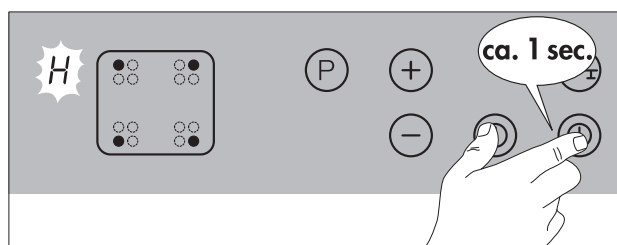

Cooking Zone Selection

To select the required cooking zone touch the corresponding sensor field for approx. one second.

A zero with a decimal point will light up in the appropriate cooking zone display window ①.

i The decimal point indicates that settings may only be made for this cooking zone.

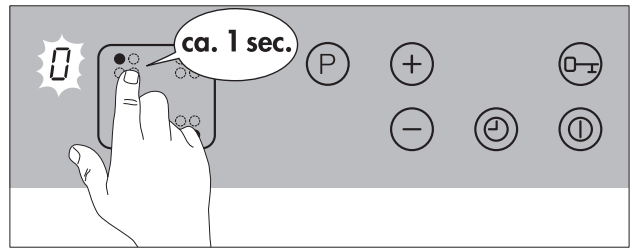

Heat Setting Selection

For setting and adjusting the heat setting (1 to 9) for the selected cooking zone.

Use sensor field ⊕ to increase the heat setting.

Lower the heat setting with sensor field ⊖.

i If several cooking zones are being used simultaneously, the required cooking zone must be selected by touching the appropriate sensor field before adjusting the heat setting. The decimal point in the display shows which cooking zone has been selected.

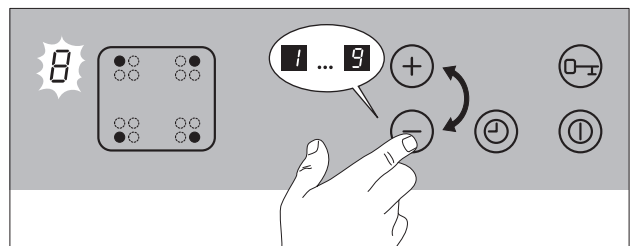

Activating the Power Function

Using the power function you can increase the power of **both front cooking zones** for 10 minutes. With this function you can, for example, bring a large quantity of water rapidly to the boil or brown meat.

To switch on the power function, the cooking zone must be selected (decimal point in the display). Touch the “Power-function” sensor field \oplus . \oplus appears in the display. The power function is now active.

i The power function will be activated for a **maximum of 10 minutes**. Following this the cooking zone automatically switches to heat setting 9.

The power function can be switched off in the following way:

- Touching the “Power function” sensor field \oplus .
- Touching the sensor field \ominus .

! As soon as the power function is activated for one of the front cooking zones, less heating power is given to the rear cooking zone.

If the power function for the front right cooking zone is activated, the rear left cooking zone can attain a maximum heat setting of “8”.

If the power function for the front left cooking zone is activated, the rear right cooking zone can attain a maximum heat setting of “7”.

If a higher setting than 7 or 8 is set for the rear cooking zones, the display for the rear cooking zone concerned will show the differing settings alternately (e.g., 7 and 9).

As soon as the power function has ended (after a maximum of 10 minutes), the rear cooking zones automatically revert to their previously set heat setting.

Switching off a Cooking Zone

1. Select the required cooking zone with the cooking zone sensor fields.
2. Touch sensor fields \oplus and \ominus simultaneously to switch off or turn sensor field \ominus back to zero.

i A cooking zone may only be switched off when the decimal point is on in the cooking zone display.

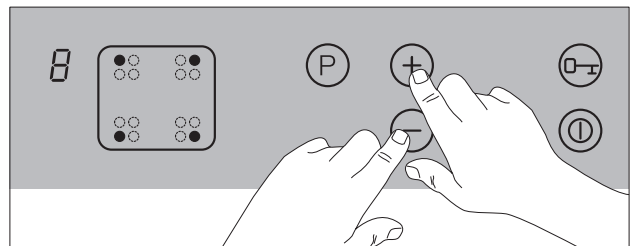

Cooking with the Automatic Heating-Up Function

All four cooking zones of the cooking field can be controlled in nine stages and have an automatic heating-up function:

- [1], Lowest heat setting
- [9], Highest heat setting
- [R], Heating-up function.

With the automatic heating-up function ([R]), the cooking zone operates for a certain time at full capacity and then automatically switches back to the heat setting selected for further cooking.

The duration of the automatic heating-up function depends on the heat setting selected for further cooking.

1. Select the required cooking zone with the cooking zone sensor fields. The decimal point in the associated display field illuminates.

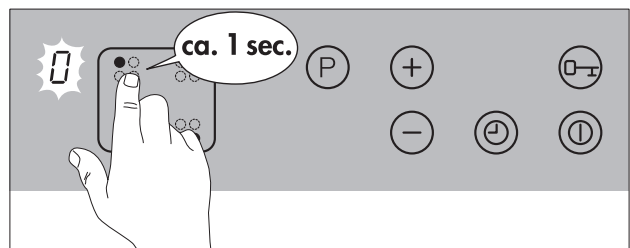

2. With the ⊕ or ⊖ sensor fields set the cooking stage [9]. Stop briefly and touch the ⊕ sensor field again.

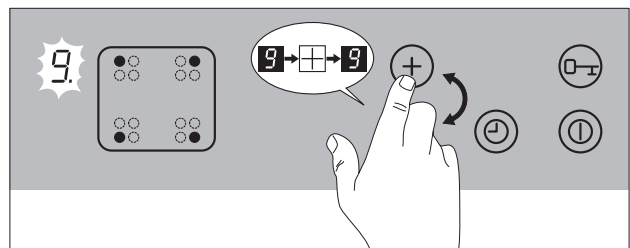

[R] lights up in the heat setting display.

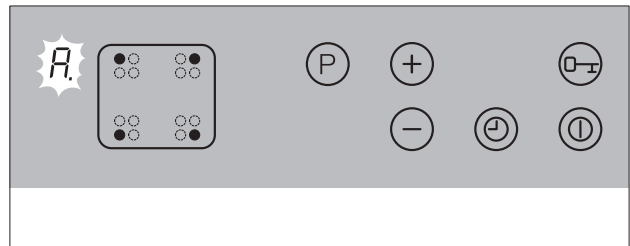

3. Next, touch the sensor field ⊖ and set the required continued heat setting [1] to [8]. The heat setting selected for further cooking then is displayed.

After 5 seconds, [R] appears in the display instead of heat setting selected for further cooking. The heat setting is displayed again after the heating-up time has ended.

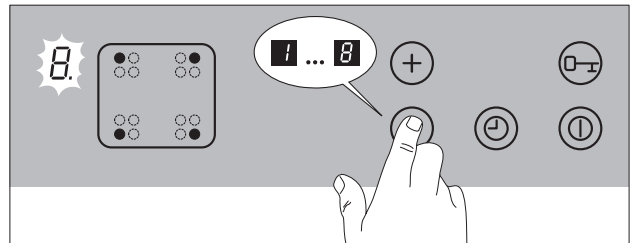

i If you select a higher heat setting when the automatic function is in operation, e.g. from [3] to [5], the previous heating-up time is taken into account. If you select a lower setting, then the automatic function is brought to an immediate end. If you start cooking again on a cooking zone that is still warm, the automatic heating-up function uses the residual heat. This saves time and energy.

Cooking without the Automatic Heating-Up Function

1. For heating up/browning, select a high power.
2. As soon as steam forms or the fat is hot, switch back to the required heat setting for the remainder of the cooking time.
3. Reset to zero in order to end cooking.



Note:

When cooking with the induction cooking zone you should take into account that

- the heating-up times are reduced by the direct energy transfer to the pan!
- the cooking process stops immediately after the cooking zone is switched off (no boiling over!)

Residual Heat Indicator

When an individual cooking zone or the entire hob is switched off, any residual heat is shown with an  (for “Hot”) in the digital display for the appropriate cooking zones.

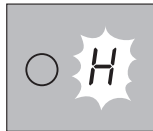

Even after the cooking zone has been switched off, the residual heat indicator only goes out when the cooking zone is cold.



You can use the residual heat for melting and keeping food warm.



Important! As long as the residual heat indicator is illuminated, there is a risk of burns.



Important! If the power supply is interrupted the  symbol will also go out and information about residual heat will no longer be available. However, it may still be possible to burn yourself. This can be avoided by taking care when near the hob.

Locking/Unlocking the Control Panel

With the exception of the “On/Off” sensor field the control panel can be locked at any required time during cooking in order to prevent adjusting the settings such as when wiping over with a cloth. This function is also suitable as a child safety feature.

1. Touch the „lock“ sensor field until the control indicator comes on.
2. To release the lock touch the „lock“ sensor field again continuously until the control indicator goes out.



Child safety feature! If the hob is completely switched off using the “On/Off” sensor field while the lock is on, then the lock will still be active when the hob is switched on again. To reactivate the cooking zones, the locking function must be cancelled as described above.

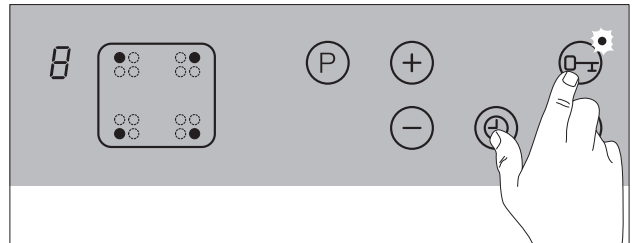

Timer

A cooking duration can be set with the integrated timer for all cooking zones. When the end of the cooking duration is reached, the cooking zone switches itself off automatically.

1. Using the cooking zone sensor field, select the required cooking zone and set the required heat setting.
2. Touch the TIMER ⊖ sensor field to activate the timer function for this cooking zone. 00 will appear in the display.

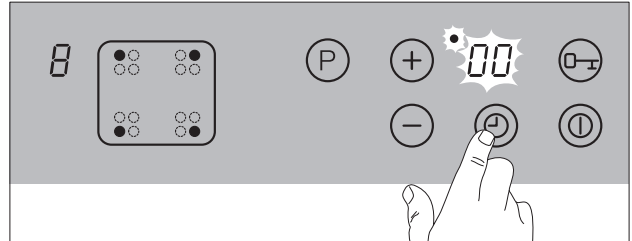

3. Using the ⊕ or ⊖ sensor fields set or adjust the required period of time until the zone is to switch off automatically (eg. 15 minutes).

After a few seconds the timer will start automatically and will show how much time remains before it will switch off.

In addition, the “Timer active” display for the relevant cooking zone will light up, e.g. the top left control indicator corresponds to the rear left cooking zone.

At the end of the set cooking time, the cooking zone will switch off automatically and an acoustic signal will sound.

4. Touch the TIMER ⊕ sensor field to switch off the signal and control indicator.

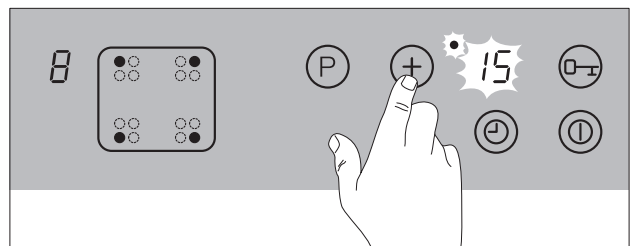

i To set the timer more quickly, leave your finger on the ⊕ or ⊖ sensor field until the required time is reached.

If the ⊖ sensor field is operated first, the time setting will begin at 99 minutes; if the ⊕ sensor field is operated first, the time setting will begin at 1 minute.

Displaying the remaining cooking time

If you select a cooking zone which is in timer mode, the cooking time still remaining appears in the timer display window.



Using the timer to measure short periods of time (“Minute Minder”)



Important! None of the cooking zones should be set with the Timer!

1. Touch the "On/Off" sensor field for around two seconds.

The digital display  flashes.

2. Touch the TIMER  sensor field to activate the Timer function.
3. Using the  or  sensor fields, set the desired length of time (for example, 20 minutes).

The Timer begins to run after a few seconds, and indicates the time remaining.



When the set time has elapsed, an audible signal is sounded.

4. Touch the TIMER  sensor field, to switch off the signal.



Ending the timer function prematurely

There are two ways of switching off the timer early:

Switching off the cooking zone and timer simultaneously

1. Select the desired cooking zone using the cooking zone buttons.
2. Touch the  and  buttons simultaneously: **The cooking zone and timer** will switch off.

Switching off the timer - leaving the cooking zone active

1. Select the desired cooking zone using the cooking zone buttons.
2. Touch the “Timer” button again.
3. Touch the  and  buttons simultaneously:
 - Only the **timer** will switch off.
 - The cooking zone will stay on.

Uses, Tables and Tips

Advice on Cooking with and without Automatic Warm up

The automatic warm up function is suitable for:

- dishes that start off cold, are heated up at high power and do not need to be continually watched when cooking on the selected heat setting,
- dishes that are put in a hot frying pan.

The automatic warm up function is not suitable for:

- goulash, beef olives and similar braised dishes that need continual turning until browned correctly, have liquid added and are then braised until cooked,
- dumplings, pasta dishes with large amounts of liquid,
- cooking with pressure cookers,
- very large quantities of soup/stew with more than 2 litres of liquid.

General notes:

- When cooking without the automatic warm up function, we recommend the use of a high heat setting to warm up the food (using the ⊖ button) and then leave the dish to finish cooking at an appropriate lower heat setting.
- You can use the  heat setting for keeping food warm.
- Take special note of the results when you first use the appliance! You can then decide which heat setting is the best for "your dishes" in the "quantities you are accustomed to preparing" with "your pans". You will then quickly appreciate the advantages of the automatic function and will feel relaxed about using your new hob.

Tip when cooking with induction cooking zones:

- In order to obtain an even cooking result, the diameter of the bottom of the pan used should not be greater than that of the cooking area indicated on the glass ceramic.

Tables

Note:

The figures given in the following tables are for guidance. The switch setting required for cooking depends on the quality of the pots and pans and on the type and quantity of the foodstuffs.

Chart for Setting the Cooking Zones

Heat setting		suitable for
9 or P	Heating Up	Heating up large quantities of water, cooking pasta
7-9	Heavy Browning	Deep-frying pommes frites (chips), browning meat, e.g. goulash, frying, e.g. potato fritters frying pieces of loin, steaks
6-7	Mild Frying	Frying meat, schnitzel, cordon bleu, chops, pancakes, rissoles, roux, mild roasting, fried sausages, liver, eggs, deep-frying doughnuts.
4-5	Boil	Cooking larger quantities of food, stews and soups, steaming potatoes, cooking meat stock or bouillon
3-4	Steaming Steaming	Steaming vegetables or braising meat cooking rice pudding
2-3	Simmering	Simmering rice or milk-based dishes, steaming smaller quantities of potatoes or vegetables, heating up ready-to-serve meals.
1-2	Melting	Fluffy omelettes, egg royale, Sauce hollandaise, keeping dishes warm, melting butter, chocolate, gelatine
0		Off setting

Chart for the Automatic Heating-Up Feature

Heat setting	Cooking processes	Example foods	Duration	Notes/tips
A7 to A8	Heavy brown- ing	Steaks	per pan 8- 20 min.	Turn occasionally
A6 to A7	Roasting	Schnitzel, Rissoles, Fried eggs, Grilled Sausages	per pan 10- 20 min.	Turn occasionally
A6 to A7	Baking	Pancakes, thin pan- cakes	bake continuous- ly	Turn occasionally
A3 to A5	Boil	Soups	40-150 min.	Up to 3 litres liquid plus ingredi- ents
A3 to A5	Steaming	Potatoes, vegetables	20-60 min.	Do not use much liquid e.g.: max. ¼ litre water for 750 g potatoes
A2 to A4	Stewing, de- frosting	Vegetables	20-45 min.	Add a little liquid (some spoon- fulls) if required
A2 to A3	Simmering	Rice, millet, buck- wheat	25-50 min.	Add at least double the quantity of liquid to the rice etc. Stir oc- casionaly
A2 to A3	Heating up	Ready meals, stews	10-30 min.	Depending on the quantity adapt the setting
1 to A2	Thickening	Fluffy omelettes, egg royale	10-20 min.	
1 to A2	melting	Chocolate/butter/ gelatine	5-25 min.	Without bain-marie Stir occasionally!

Cleaning and Care

Advantages for Cleaning and Caring for the Induction Cooking Zone



The cleaning effort for induction ceramic glass cooking surfaces is considerably less than for cooking surfaces with radiant heating:

- The induction cooking zone reacts faster to switching down and off. Boiling over and burning in of dishes is avoided to a large degree.
- The temperatures on the ceramic glass surface are clearly lower with inductive cooking than with the conventional radiant heating systems.

Since the heat is generated in the pan, food or food-stuffs possibly on the glass ceramic surface are not burnt in as badly.

Hob



Important: Cleaning agents must not come into contact with the **hot** ceramic glass surface! All cleaning agents must be removed with plenty of clean water after cleaning because they can have a caustic effect when the rings are next heated!

Do not use any aggressive cleaners such as grill or oven sprays, coarse scourers or abrasive pan cleaners.



Clean the ceramic glass surface after each use when it is warm to the touch or cold. This will avoid spillages becoming burnt on.

Remove scale and water marks, fat spots and discolouration with a metallic shimmer using a commercially available ceramic glass or stainless steel cleaner.

Light Soiling

1. Wipe the ceramic glass surface with a damp cloth and a little washing up liquid.
2. Then rub dry with a clean cloth. Remnants of cleaner must not be left on the surface.
3. Thoroughly clean the entire ceramic glass cooking surface once a week with a commercially available ceramic glass or stainless steel cleaner.
4. Then wipe the ceramic glass surface using plenty of clean water and rub dry with a clean fluff-free cloth.

Stubborn Soiling

1. To remove food that has boiled over or stubborn splashes, use a glass scraper.
2. Place the glass scraper at an angle to the ceramic glass surface.
3. Remove soiling by sliding the blade.

 You can obtain glass scrapers and ceramic glass cleaners from specialist retailers.

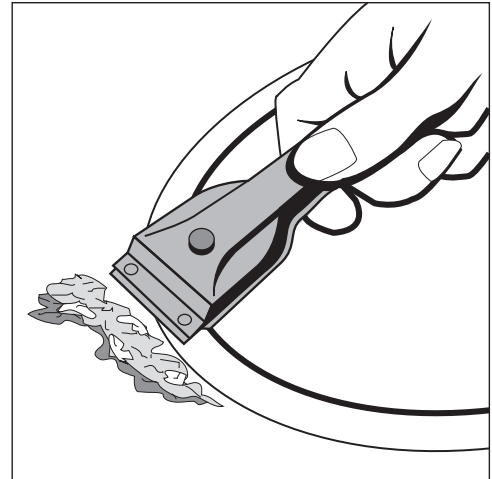

Problem Dirt

1. Remove burnt-on sugar, melted plastic, aluminium foil or other meltable materials with a glass scraper **immediately and while still hot**.

 **Important:** There is a risk of burning yourself when the glass scraper is used on a hot cooking zone!

2. Then clean the hob normally when it has cooled down.

 If the cooking zone on which something has melted has already cooled down, warm it up again for cleaning.

Scratches or dark marks on the ceramic glass surface, caused for example by a pan base with sharp edges, cannot be removed. However, they do not impair the function of the hob.

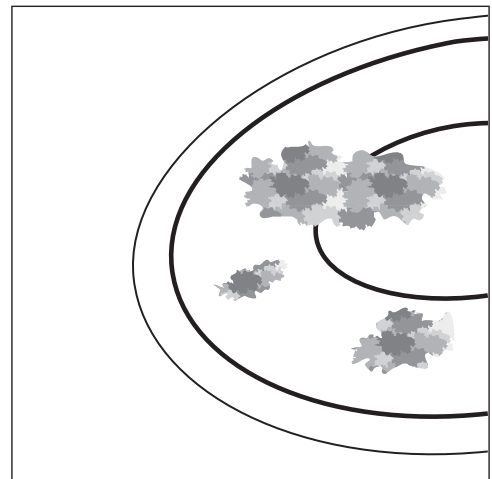

Hob Frame

 **Important!** Do not put vinegar, lemon-juice or scale removers on the hob frame, otherwise dull spots will appear.

1. Wipe the frame with a damp cloth and a little washing up liquid.
2. Soften dried dirt with a wet cloth. Then wipe off and rub dry.

What to do if ...

Rectifying faults

It is possible that faults have been caused by a minor error, which you can correct yourself with the help of the following instructions. Do not attempt any further repairs if the following instructions do not help in each specific case.



Warning! Repairs to the appliance are only to be carried out by approved service engineers. Improperly effected repairs may result in considerable risk to the user. If your appliance needs repairing, please contact your specialist dealer or customer service.

If the ceramic glass hob is broken, please quote the **3-digit number** on the glass hob when contacting customer service.

What to do if ...

... the appliance develops a fault or the ceramic glass hob is broken or cracked.

- Switch off all cooking zones.
- Switch off the fuse for the cooking zone or take it out.

... the cooking zones are not working.

Check whether

- the appropriate fuse in the house installation (fuse box) is intact. If fuses are triggered more than once, call a qualified electrician.
- the appliance is switched on properly,
- the control lights on the operating panel are illuminated,
- the appropriate cooking zone is switched on,
- the cooking zones are set to the desired heat (see chapter “Cooking”),
- the safety shut-down for the cooking zones has triggered (see chapter “Safety devices”).

... the cooking zones will not switch on.

Check whether

- the operating panel is locked (see chapter “Locking the operating panel”).
- a period of more than 10 seconds elapses after operating the “On/Off” switch and before the selected cooking zone comes on (see chapter “Switching on the appliance”).
- the sensor fields may be partially covered by a damp cloth or by liquid.

... the residual heat indicator suddenly fails to operate except for or .

Check whether

- the “On/Off” switch was activated by mistake.
- the sensor fields may be partially covered by a damp cloth, liquid or similar.
- the safety shut-down was activated.

... the letter or is still displayed by the residual heat indicator after switching off the cooking zones.

Check whether

- the cooking zone has only been on for a short time and is therefore not yet hot enough.

If the cooking zone is hot, please ring customer service.

... a cooking zone cannot be switched off

Check whether

- the sensor fields may be partially covered by a damp cloth or by liquid.
- the lock mechanism is switched on.

... a cooking zone cannot be switched on

Check whether

- the lock mechanism is switched on.

... the indicator is flashing

Check whether

- the pan is located on the correct cooking zone,
- the diameter of the pan base is too small for the cooking zone,
- the pan is suitable for induction.

... appears on the display

Check whether

- the cooking zone has overheated.
switch off the appropriate cooking zone and let it cool down. Try switching on the cooking zone again using a suitable pan after a few minutes.
- the automatic switch-down for the cooking zone has triggered.
You can reactivate the cooking zone by switching it off and on briefly.

... the power function cannot be switched on?

- Switch off the cooking zone for approx. 10 minutes.

If this fault occurs repeatedly, check

- whether the requisite ventilation gap between the work surface and the cabinet panel underneath it has been covered over.
- that a sufficiently large ventilation gap was maintained under the work surface when the appliance was installed (5 mm).

Installation Instructions



Important! The new appliance may only be installed and connected by **qualified personnel**.

Please observe this instruction, otherwise the warranty will not cover any damage that may occur.

Technical Data

Appliance dimensions

Width	761 mm
Depth	501 mm
Height	55 mm

Worktop cut-out dimensions

Width	750 mm
Depth	490 mm
Corner radius	R5

Cooking rings

Position	Diameter	Power
Front left	210mm	2200W
		(Power function 3000W)
Rear left	180mm	1800W
Rear right	145mm	1400W
Front right	180mm	1800W
		(Power function 2300W)

Note: The quoted power consumption may vary according to size and material of pans used.

Connection voltage 230 V ~ 50Hz

Maximum connected load power 7,2kW

Regulations, Standards, Directives

This appliance meets the following standards:

- EN 60 335-1 and EN 60 335-2-6 relating to the safety of electrical appliances for household use and similar purposes and
- EN 60350, or DIN 44546 / 44547 / 44548 relating to the operating features of electric cookers, hobs, ovens, and grills for household use.
- EN 55014-2
- EN 55014
- EN 61000-3-2
- EN 61000-3-3
- relating to basic requirements for electro-magnetic compatibility protection (EMC).



This appliance complies with the following EU Directives:

- 73/23/EEG dated 19.02.1973 (Low Voltage Directive)
- 89/336/EEG dated 03./05.1989 (EMC Directive including Amending Directive 92/31/EEG).

Safety Instructions for the Installer

- A device must be provided in the electrical installation which allows the appliance to be disconnected from the mains at all poles with a contact opening width of at least 3 mm.
Suitable isolation devices include line protecting cut-outs, fuses (screw type fuses are to be removed from the holder), earth leakage trips and contactors.
- In respect of fire protection, this appliance corresponds to EN 60 335-2-6. This type of appliance may be installed with a high cupboard or wall on one side.
- Drawers may not be fitted underneath the hob.
- The installation must guarantee shock protection.
- The kitchen unit in which the appliance is fitted must satisfy the stability requirements of DIN 68930.
- For protection against moisture, all cut surfaces are to be sealed with a suitable sealant.
- On tiled work surfaces, the joints in the area where the hob sits must be completely filled with grout.
- On natural, artificial stone, or ceramic tops, the snap action springs must be bonded in place with a suitable artificial resin or mixed adhesive.
- Ensure that the seal is correctly seated in the frame and that it is seated against the work surface without leaving any gaps. Additional silicon sealant must not be applied; this will make removal more difficult when servicing.
- The hob must be pressed out from below when removed.

For Australia:

- **CAUTION:** The surface temperature exceeds 95°C. To avoid a hazard, underbench access must be restricted.
- Supply cords must have a temperature rating not less than 105°C.

Electrical Connection

Before connecting, check that the nominal voltage of the appliance, that is the voltage stated on the rating plate, corresponds to the available supply voltage. The rating plate is located on the lower casing of the hob.

The heating element voltage is AC230V~. The appliance also works perfectly on older networks with AC220V~.

The hob is to be connected to the mains using a device that allows the appliance to be disconnected from the mains at all poles with a contact opening width of at least 3 mm, eg. automatic line protecting cut-out, earth leakage trips or fuse.

A type H05VV-F cable or one with a higher grade must be used as the mains connecting cable.

The connection must be carried out as shown in the diagram. The connecting links should be fitted according to the appropriate connection diagram. The earth lead is connected to terminal Ⓧ. The earth lead must be longer than leads carrying electric current.

The cable connections must be made in accordance with regulations and the terminal screws tightened securely.



Finally, the connecting cable is to be secured with the mains cable cleat and the covering closed by pressing firmly (lock into place).

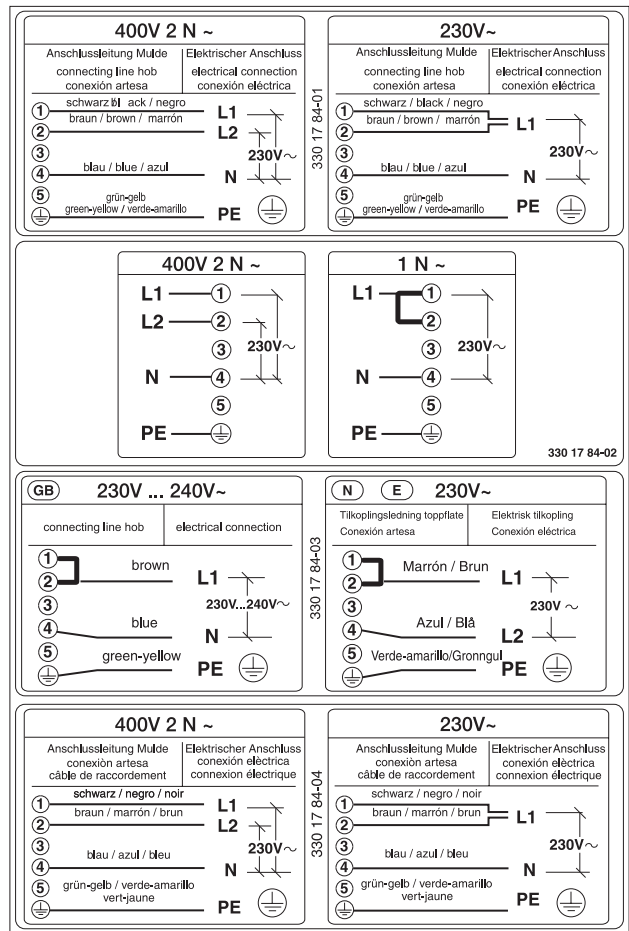

Before switching on for the first time, any protective foil or stickers must be removed from the glass ceramic surface.

 Once connected to the mains supply check that all cooking zones are ready for use by briefly switching each on in turn at the maximum setting.



Rating Plate

Modell	EHD 8680 X	Prod.Nr.	949591164
Typ	55GBD 84AE	230 V AC 50 Hz	
Made in Germany	Ser.Nr.		7,2 kW
			

Modell	EHD 8680 U	Prod.Nr.	949591165
Typ	55GBD 84AE	230 V AC 50 Hz	
Made in Germany	Ser.Nr.		7,2 kW
			

Guarantee Conditions

ELECTROLUX WARRANTY AUSTRALIA

Nothing in this warranty, limits any rights you may have under the Trade Practices Act or any other Commonwealth or State legislation. Such rights cannot be changed by the conditions in this warranty.

Subject to the conditions below, this appliance is warranted by Electrolux Home Products Pty. Ltd. A.B.N. 51 004 762 341, (the "Company"), to be free from defects in materials and workmanship for a period of 24 months following the date of purchase (the "Warranty Period").

Conditions of the warranty:

3. During the Warranty Period the Company, or its service agent, will only pay the cost of repairing or replacing all Company parts on your appliance which the Company finds to be defective.
4. The Company will decide if there are any defects in material and/or workmanship.
5. Light globes, batteries and filters are replaceable parts and are not covered under this warranty.
6. This warranty applies only for mainland Australia and Tasmania.
7. The appliance must be installed and operated in accordance with the Company's instructions.
8. This warranty does not apply to normal wear and tear, or any service, which is needed after an accident, alteration, negligence, misuse, fire or flood.
9. This warranty does not apply to damage caused if your appliance has been dismantled, repaired or serviced by any person other than someone authorised by the Company.
10. If you live outside the service area of the Company or one of its service agents, this warranty does not cover the cost of transport of the appliance for service nor the service agent's travelling costs to and from your home.
11. If you are required to transport the appliance to the Company or its service agent, you must ensure it is securely packed and insured. The Company does not accept any responsibility for loss or damage of the appliance prior to it being received by the Company or its service agent.
12. This warranty does not cover loss, damage or expense to this appliance caused directly or indirectly by power surges, electrical storm damage or incorrect power current.
13. The Company (and any company related to the Company) will not be liable for any special, incidental or consequential damages or for loss, damage or expense or for personal injury or loss or destruction of property arising directly or indirectly from the use or inability to use this appliance or any of its parts.

14. This warranty applies only to the original buyer.
15. This warranty is the only express warranty given by the Company.
16. If you are the original buyer, please keep your proof of purchase, which will be required, if you request service under this warranty.
17. The Warranty Period is only applicable when your appliance is used at home by you and your family as consumers.
18. Use of this appliance for commercial purposes is covered by this warranty for a period of 3 months from the date of purchase.

FOR SERVICE IN AUSTRALIA

PLEASE CALL

13 13 49

FOR SPARE PARTS IN AUSTRALIA

PLEASE CALL

13 13 50

ELECTROLUX APPLIANCE WARRANTY - NEW ZEALAND

This appliance is warranted by Electrolux Home Products (NZ) Ltd ("the Company") from the date of purchase. The following terms and conditions apply:

1. The Company or its Authorised Service Centre will pay the cost of repairing or replacing all parts of the appliance which the Company or its Authorised Service Centre find defective for a period of 24 months following the date of purchase (the "Warranty Period").
2. During the Warranty Period the Company or its Authorised Service Centre, will pay the cost of repairing or replacing all parts, which they find are defective.
3. Light globes, batteries and filters are replaceable parts and are not covered under this warranty.
4. The appliance must be installed and operated in accordance with the Company's instructions.
5. This Warranty does not apply to normal wear and tear, or any service, which is needed after an accident, negligence, alteration or misuse.
6. This Warranty also does not apply to damage caused if your appliance has been dismantled, repaired or serviced by any person other than someone authorised by the Company.
7. If you live outside the service area of the Company or its Authorised Service Centre, this warranty does not cover the cost of transport of the appliance for service nor the Authorised Service Centre's travelling costs to and from your home.
8. If you are required to transport the appliance to the Company or its Authorised Service Centre, it must be securely packed and insured. The Company does not accept any responsibility for loss or damage prior to it being received by the Company or its Authorised Service Centre.
9. This warranty is the only express warranty given by the Company.
10. This Warranty does not cover loss, damage or expense to this appliance caused directly or indirectly by power surges, electrical storm damage or incorrect power current.
11. The Company (and any company related to the Company) will not be liable for any special incidental or consequential damages or for loss, damage or expense directly or indirectly arising from the use or inability to use this appliance, or for personal injury or loss or destruction of other property.
12. Nothing in this warranty is intended to limit the rights you may have under the Consumer Guarantees Act 1993, except to the extent permitted by that Act, and all provisions of this warranty shall be read as modified to the extent necessary to give effect to that intention.
13. The Consumer Guarantees Act 1993 does not apply if your appliance is acquired for the purposes of a "business" (as defined in that Act).

14. This warranty is limited to 90 days from date of purchase if the appliance is used for commercial use.

IMPORTANT NOTICE

Before calling a service technician please carefully check the warranty terms and conditions, the operating instructions and service booklet if applicable. If the product fails for any of the customer responsibility reasons detailed therein, a service fee will be charged. Please present proof of purchase to any **Authorised** Service Centre should warranty service be required.

SERVICE CENTRES PLEASE PHONE 0800 10 66 10

For your nearest Authorised Service Centre please look in The Yellow Pages under Home Appliance Servicing
OR
Call 0800 10 66 10

Service

In the “What to do if ...” section a number of mal-functions are listed that you can rectify yourself. Look there first if a fault occurs.

Is it a technical fault?

If so, please contact your customer service centre. (You will find addresses and telephone numbers in the section “Customer Service Centres”.)

Always prepare in advance for the discussion. This will make diagnosis of the problem easier and also make it easier to decide if a customer service visit is necessary:

Please make a note of the following information as accurately as possible:

- What form does the fault take?
- Under what circumstances does the fault occur?

Prior to the telephone call it is important that you make a note of the following appliance code numbers that are given on the rating plate:

- model description,
- PNC code (9 digits),
- S No code (8 digits).

We recommend that you record the code numbers here so that you always have them to hand:

Model:
PNC:
S-No:

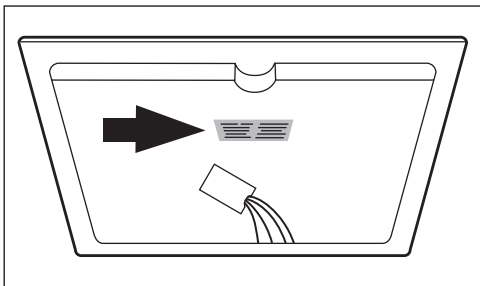

When do you incur costs even during the warranty period?

- if you could have remedied the fault yourself using the fault table (see section “What to do if ...”),
- if the customer service technician has to make several journeys because he was not provided with all the relevant information before his visit and therefore, for example, has to fetch spare parts. These multiple trips can be avoided if you prepare your phone call as described above.

Assembly

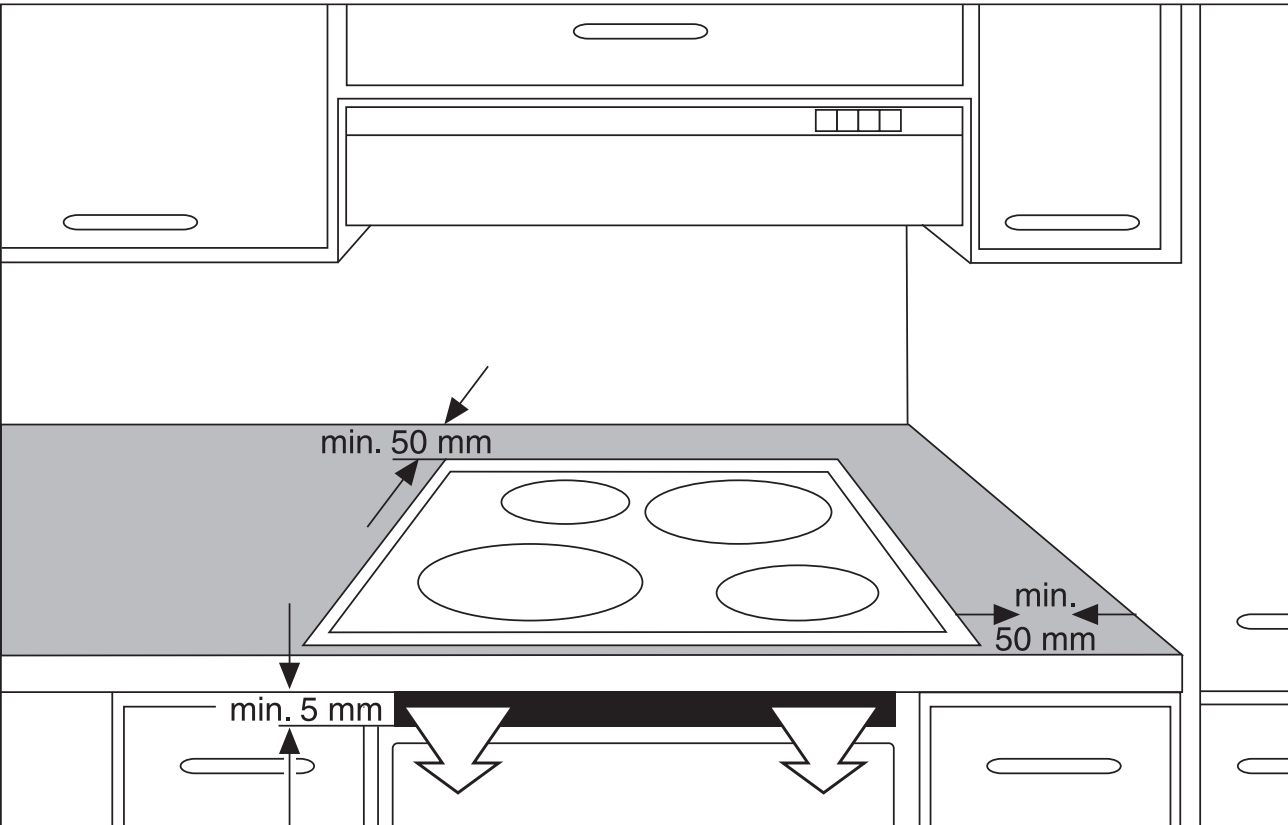
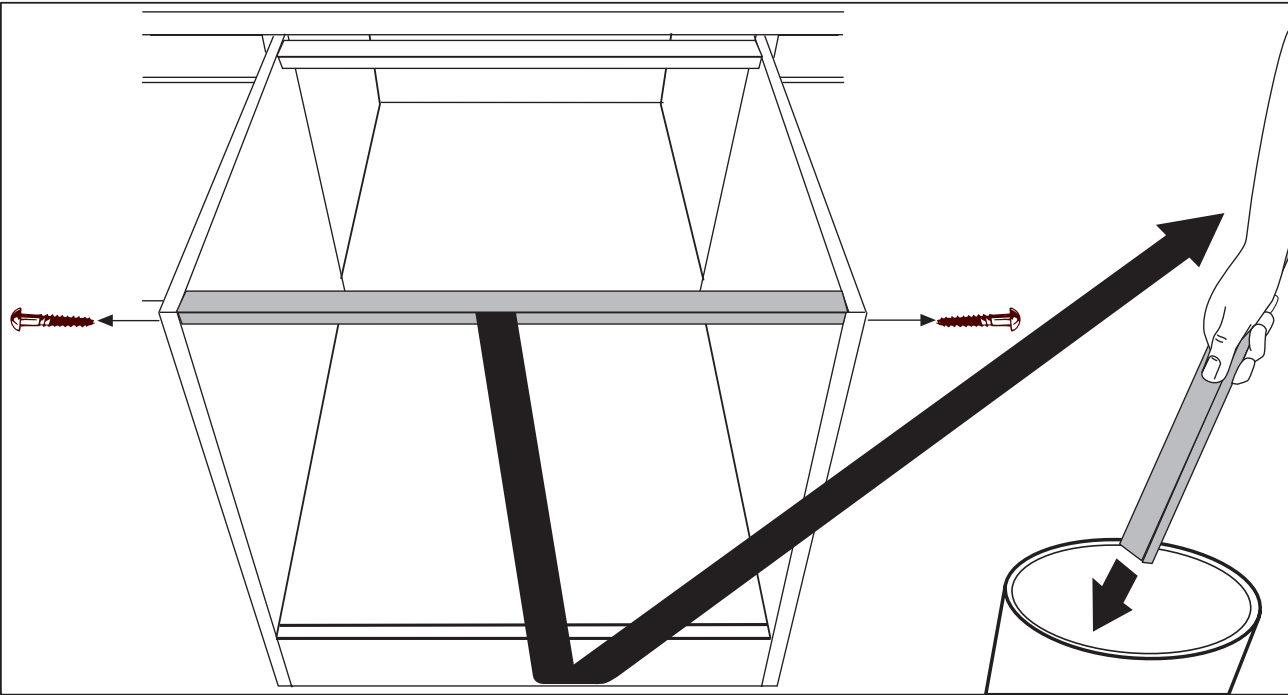

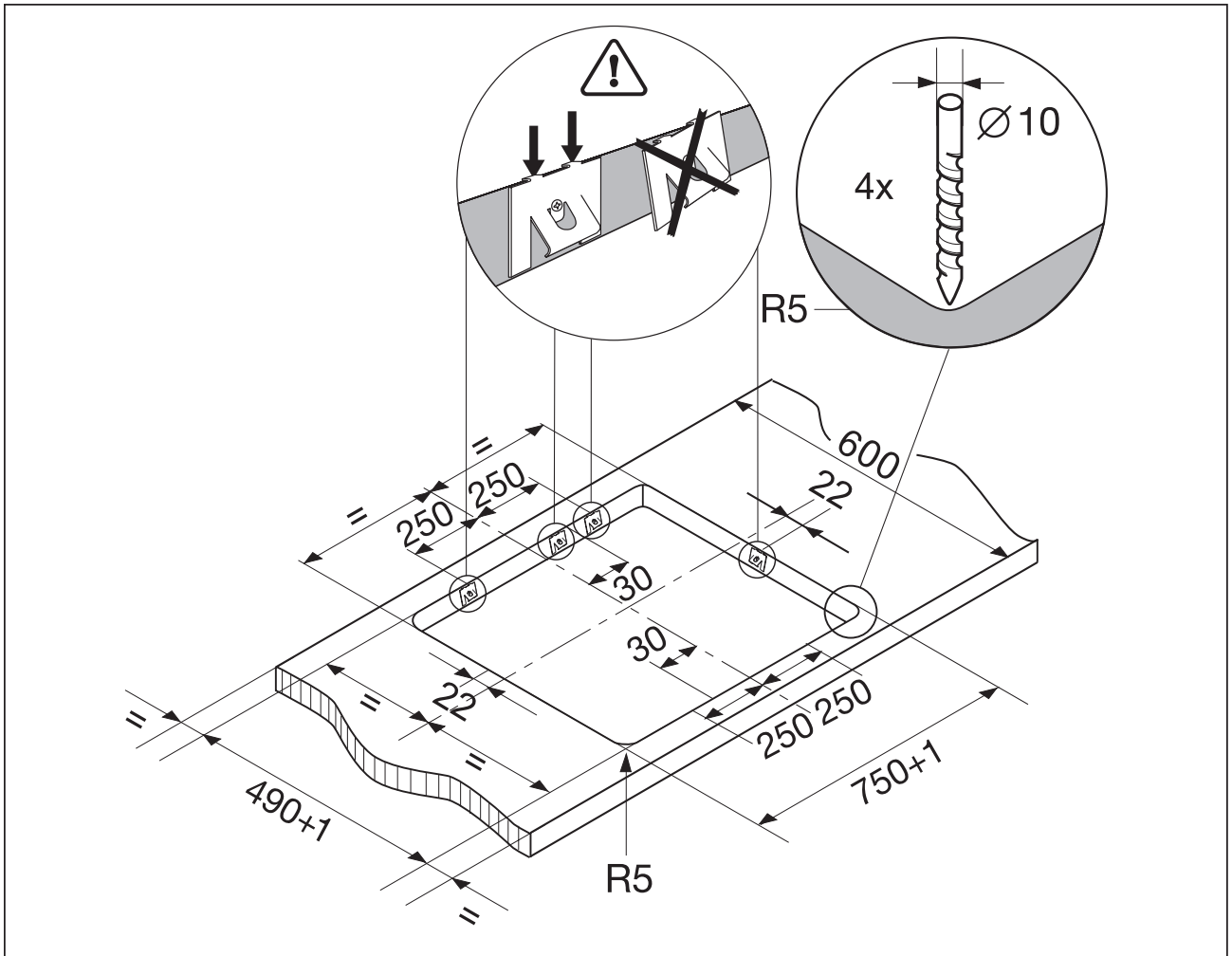

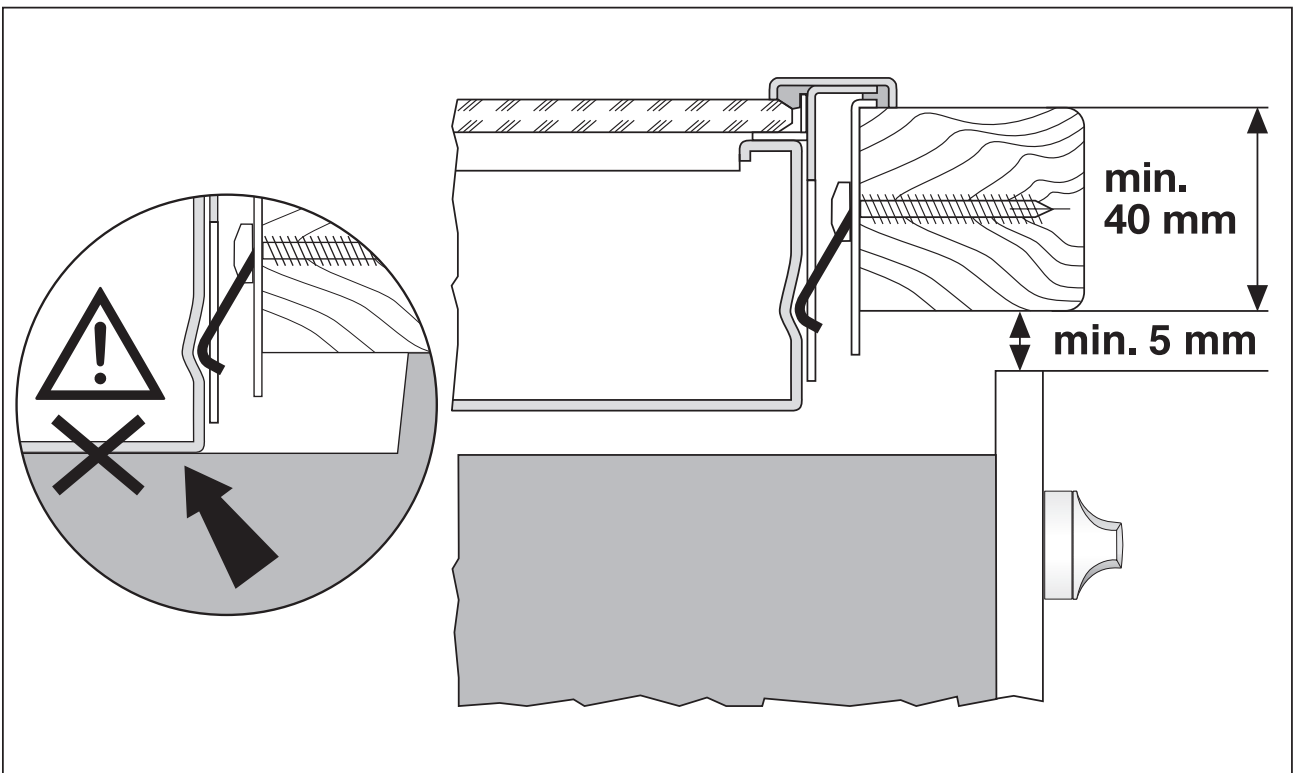
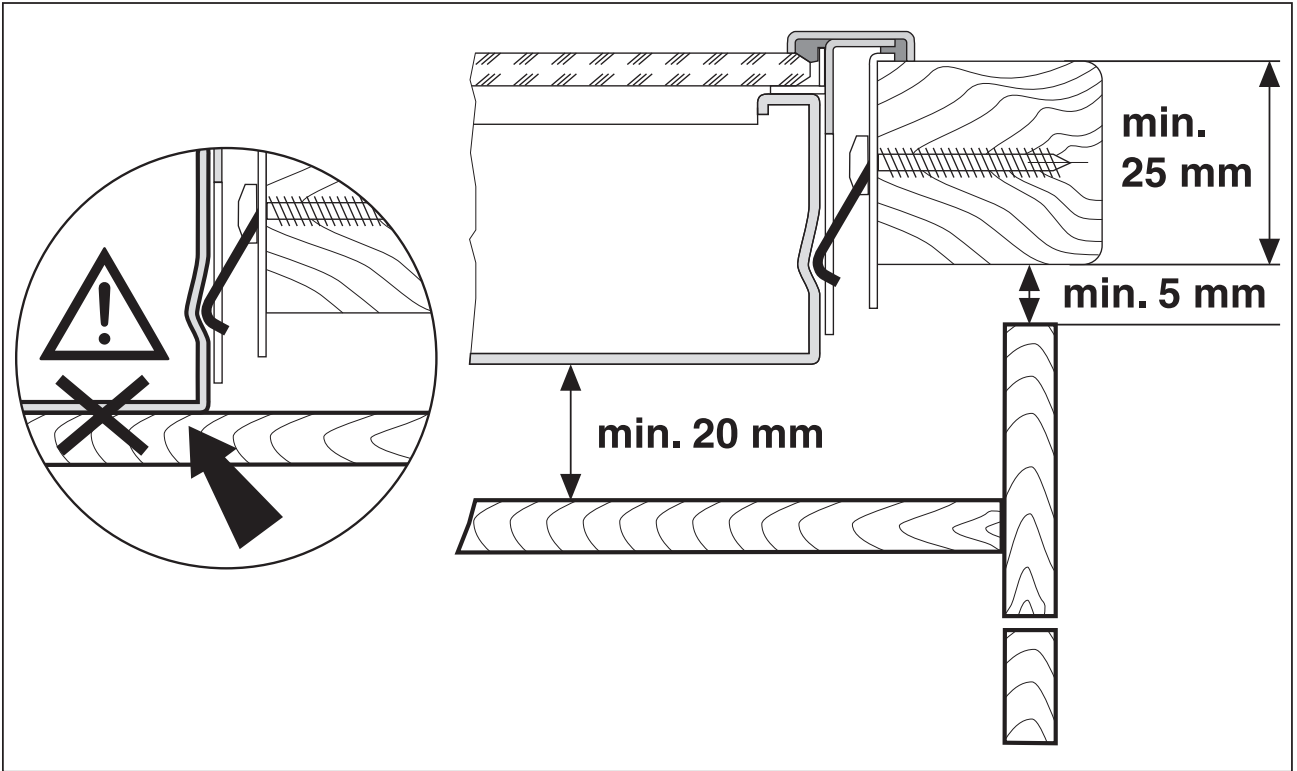

319 651 700-B-181202-03

Subject to change without notice

 **The Electrolux Group. The world's No.1 choice.**

The Electrolux Group is the world's largest producer of powered appliances for kitchen, cleaning and outdoor use. More than 55 million Electrolux Group products (such as refrigerators, cookers, washing machines, vacuum cleaners, chain saws and lawn mowers) are sold each year to a value of approx. USD 14 billion in more than 150 countries around the world.