



*Thinking of you*  
**Electrolux**



EDC2086PDW

.....  
**EN TUMBLE DRYER**

.....  
**USER MANUAL**



# CONTENTS

1. CONDITIONS OF USE . . . . .	3
2. SAFETY INSTRUCTIONS . . . . .	3
3. PRODUCT DESCRIPTION . . . . .	5
4. CONTROL PANEL . . . . .	6
5. PROGRAMME TABLE . . . . .	7
6. OPTIONS . . . . .	8
7. SETTINGS . . . . .	9
8. DAILY USE . . . . .	10
9. HINTS AND TIPS . . . . .	11
10. CARE AND CLEANING . . . . .	11
11. TROUBLESHOOTING . . . . .	14
12. TECHNICAL DATA . . . . .	15
13. SERVICE . . . . .	15
14. WARRANTY . . . . .	15

## WE'RE THINKING OF YOU

Thank you for purchasing an Electrolux appliance. You've chosen a product that brings with it decades of professional experience and innovation. Ingenious and stylish, it has been designed with you in mind. So whenever you use it, you can be safe in the knowledge that you'll get great results every time.

Welcome to Electrolux.

**Visit our website for:**



Get usage advice, brochures, trouble shooter, service information:  
**[www.electrolux.com](http://www.electrolux.com)**



Register your product for better service:  
**[www.electrolux.com/productregistration](http://www.electrolux.com/productregistration)**

## CUSTOMER CARE AND SERVICE

We recommend the use of original spare parts.

When contacting Service, ensure that you have the following data available.

The information can be found on the rating plate. Model, PNC, Serial Number.



Warning / Caution-Safety information



General information and tips



Environmental information

Subject to change without notice.

# 1. CONDITIONS OF USE

This appliance is intended to be used in household and similar applications such as:

- Farm Houses

- By clients in serviced apartments, holiday apartments and other residential type environments

## 2. SAFETY INSTRUCTIONS

Before the installation and use of the appliance, carefully read the supplied instructions. The manufacturer is not responsible if an incorrect installation and use causes injuries and damages. Always keep the instructions with the appliance for future reference.



— Caution, risk of fire!

### 2.1 Children and vulnerable people safety



#### **WARNING!**

Risk of suffocation, injury or permanent disability.

- This appliance can be used by children aged from 8 years and above and persons with reduced physical, sensory or mental capabilities or lack of experience and knowledge if they have been given supervision or instruction for the operation of the appliance by a person who is responsible for their safety.
- Do not let children play with the appliance.
- Keep all packaging away from children.
- Keep all detergents away from children.
- Keep children and pets away from the appliance door when it is open.
- Cleaning and user maintenance shall not be made by children without supervision.
- Make sure that the floor where you install the appliance is flat, stable, heat resistant and clean.
- Do not install or use the appliance where the temperature is less than 5°C or higher than 35°C.
- Do not install the appliance behind a lockable door, a sliding door or a door with a hinge on the opposite side, where the appliance door can not be fully opened.
- Always be careful when you move the appliance because it is heavy. Always wear safety gloves.
- Always move the appliance vertically.
- The rear surface of the appliance must be put against the wall.
- Make sure that there is air circulation between the appliance and the floor.
- Make sure the carpet does not obstruct the ventilation openings in the base of the appliance (if applicable).
- Exhaust air must not be discharged into a flue which is used for exhausting fumes from appliances burning gas or other fuels.
- If the tumble dryer is put on top of a washing machine, use the stacking kit. The stacking kit, available from your authorized vendor, can be used only with the appliance specified in the instructions, supplied with the accessory. Read it carefully before installation (Refer to the Installation leaflet).
- Ensure you have good ventilation in the installation room to avoid the back flow of gases into the room from appliances burning other fuels, including open fires.
- The appliance can be installed as free-standing or below the kitchen counter with correct space (Refer to the Installation leaflet).

### 2.2 Installation

- Remove all the packaging.
- Do not install or use a damaged appliance.
- Obey the installation instruction supplied with the appliance.

- When the appliance is put in its permanent position, check if it is fully level with the aid of a spirit level. If it is not, adjust the feet until it is.

## Electrical connection



### **WARNING!**

Risk of fire and electrical shock.

- The appliance must be earthed.
- Make sure that the electrical information on the rating plate agrees with the power supply. If not, contact an electrician.
- Always use a correctly installed shock-proof socket.
- Do not use multi-plug adapters and extension cables.
- Make sure not to cause damage to the mains plug and to the mains cable. Should the appliance power supply cable need to be replaced, this must be carried out by our Service Centre.
- Connect the mains plug to the mains socket only at the end of the installation. Make sure that there is access to the mains plug after the installation.
- Do not pull the mains cable to disconnect the appliance. Always pull the mains plug.
- Do not touch the mains cable or the mains plug with wet hands.
- This appliance complies with the E.E.C. Directives.

## 2.3 Use



### **WARNING!**

Risk of fire, explosion, electric shock or damage to the appliance

- Do not run the appliance without a filter. Clean the lint filter before or after each use.
- Wipe away lint that has accumulated around the appliance.
- Do not dry the damaged items which contain padding or fillings.
- Do not dry items such as foam rubber (latex foam), shower caps, waterproof textiles, rubber backed articles and clothes or pillows fitted with foam rubber pads..
- Before drying items that have been in contact with substances such as cooking oil, acetone, alcohol, petrol, kerosene, spot removers, turpentine, waxes and wax removers, wash them in hot water with an extra amount of detergent.
- Do not dry items in the appliance if industrial chemicals have been used for cleaning.
- Make sure that no gas lighters or matches have been left in the pockets of the clothing.
- Only dry fabrics which are applicable to dry in the tumble dryer. Follow the instructions on the fabric label.
- Do not dry not washed items in the appliance.
- If you have washed your laundry with a stain remover start an extra rinse cycle before you start the dryer.
- Do not drink or prepare food with the condensed water. It can cause health problems to people and pets.
- Do not sit or stand on the open door.
- Obey the maximum load volume of 8 kg (refer to the "Programme chart" chapter).
- Do not dry dripping wet clothes in the tumble dryer.
- Oil-affected items can ignite spontaneously, especially when exposed to heat sources such as in a tumble dryer. The items become warm, causing an oxidation reaction in the oil. Oxidation creates heat. If the heat cannot escape, the items can become hot enough to catch fire. Piling, stacking or storing oil-affected items can prevent heat from escaping and create a fire hazard.
- If it is unavoidable that fabrics that contain vegetable or cooking oil or have

- Use this appliance in a household only.
- Do not change the specification of this appliance.
- The final part of the drying cycle occurs without heat (cool down cycle) to ensure that the items will not be damaged.

If you stop the appliance before the end of the drying cycle, immediately remove and spread out all items, so that the heat can dissipate.

- If you use fabric softener or similar products, obey the instructions on the packaging.

been contaminated by hair care products be placed in a tumble dryer they should first be washed in hot water with extra detergent -this will reduce, but not eliminate, the hazard.

## 2.4 Care and Cleaning



### WARNING!

Risk of injury or damage to the appliance.

- Before maintenance, deactivate the appliance and disconnect the mains plug from the mains socket.
- Do not use water spray and steam to clean the appliance.
- Clean the appliance with a moist soft cloth. Only use neutral detergents. Do

not use abrasive products, abrasive cleaning pads, solvents or metal objects.

## 2.5 Disposal



### WARNING!

Risk of injury or suffocation.

- Disconnect the appliance from the mains supply.
- Cut off the mains cable and discard it.
- Remove the door catch to prevent children and pets to get closed in the appliance.

## 3. PRODUCT DESCRIPTION

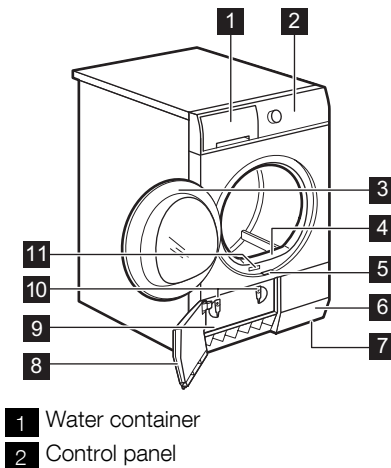



- 3 Appliance door
- 4 Filter
- 5 Button for condenser door
- 6 Airflow slots
- 7 Adjustable feet
- 8 Condenser door
- 9 Condenser cover
- 10 Locks for condenser lid
- 11 Rating plate





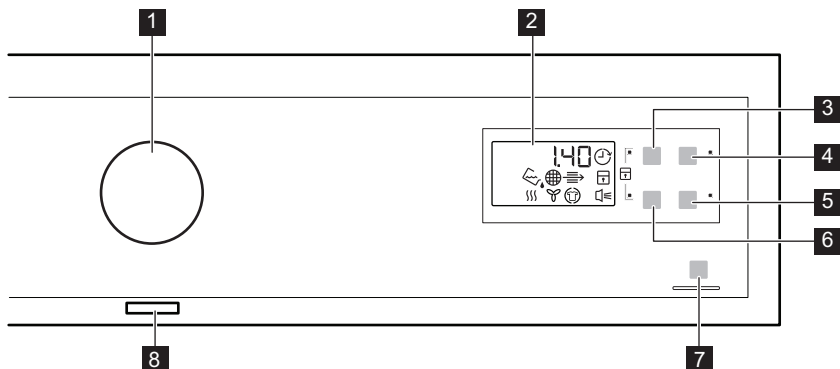

The load door can be installed by the user in the opposite side. It can help to easily put and remove the laundry or if there is a limit to install the appliance (see separate leaflet).

## 4. CONTROL PANEL











- 1** Programme knob
- 2** Display
- 3** Time  touchpad
- 4** Delay  touchpad















- 5** Delicate  touchpad
- 6** Wool Load  touchpad
- 7** Start/Pause  touchpad
- 8** On/Off  button



Touch the touchpads with your finger in the area with the symbol or the name of the option. Do not wear gloves when you operate with the control panel. Make sure that the control panel is always clean and dry.

Indicators	Description
	Acoustic signals.
	Child lock.
	Water container.
	Filter.
	Condenser.
	Drying phase.
	Cooling phase.
	Crease guard phase.
	Delay start.
2.00	Programme duration.
10' - 2.00	Time Drying duration.
30' - 20h	Delay start duration.

## 5. PROGRAMME TABLE

Programmes	Type of load / Load (max.) <sup>1)</sup> / Fabric mark
 Cotton fabrics	
 Extra Dry	Drying level: extra dry. / <b>8kg</b> /  
 Strong Dry <sup>2)</sup>	Drying level: strong dry. / <b>8kg</b> /  
 Cupboard Dry	Drying level: cupboard dry. / <b>8kg</b> /  
 Iron Dry	Drying level: applicable for iron. / <b>8kg</b> /  
 Synthetic fabrics	
 Extra Dry	Drying level: extra dry. / <b>3,5kg</b> /   
 Cupboard Dry	Drying level: cupboard dry. / <b>3,5kg</b> /   
 Iron Dry	Drying level: applicable for iron. / <b>3,5kg</b> /   
 Easy Iron	Easy care fabrics for which a minimum of ironing is necessary. The drying results can be different from one type of fabric to the other. Shake the items before you put them in the appliance. When the programme is completed, Immediately remove the items and put them on a hanger. / <b>1kg (or 5 shirts)</b> /   
 Duvet	To dry a single or a double duvet and pillows that are filled with feather or synthetic filling. Delicate programme with warm air. / <b>3kg</b> /   
 Delicates	Silk fabrics and lingerie. Delicate programme with warm air. / <b>3kg</b>
 Wool <sup>3)</sup>	Wool fabrics. Remove the items immediately when the programme is completed. / <b>1kg</b> Gentle drying washable woollens and sport shoes (Only with the Drying Rack — see separate user manual provided with Drying Rack). / <b>1kg (or 1 pair of sport shoes)</b>
	
 Refresh	Refreshing textiles that were in storage. / <b>1kg</b>
 Time Drying	With this programme you can use manual timing option and set the programme duration. / <b>8kg</b> /   
 Rapid	To dry cotton and synthetic fabrics, uses low temperature. / <b>2kg</b> /   

<sup>1)</sup> The maximum weight refers to dry items.

- 2) **Energy labelling program:** Standard program for tests are specified in the AS/NZS 2442 document.
- 3) The wool drying cycle of this machine has been approved by The Woolmark Company for the drying of machine washable wool products provided that the products are washed and dried according to the instructions on the garment label and those issued by the manufacturer of this machine. M1221. In UK, Eire, Hong Kong and India the Woolmark symbol is a certification trademark

## 6. OPTIONS

### 6.1 Time

This option is applicable to the Time Drying programme and to the Wool programme (only with the Drying Rack).



We recommend that you set a short duration for small quantities of laundry or for only one item.

- **Time Drying programme:** You can set the programme duration, from a minimum of 10 minutes to a maximum of 2 hours. The setting of the duration is related to the quantity of laundry in the appliance.
- **Wool programme:** You can set the programme duration, from a minimum of 30 minutes to a maximum of 4 hours. The setting of the duration is related to the quantity of laundry in the appliance.













If you press Time option for Wool programme, Wool Load option is automatically blocked.

### 6.2 Wool Load









This option is applicable only to the Wool programme. To get laundry more dried press the  Wool Load touchpad again and again to increase the programme duration.

### 6.3 Delicate

With this option you can set a delicate drying programme that has a low temperature. Use this option with synthetic fabrics that have the symbol  on the fabric label (e.g. acrylic, viscose).

Programmes <sup>1)</sup>			
 Cotton fabrics			
 Extra Dry			•
 Strong Dry			•
 Cupboard Dry			•
 Iron Dry			•
 Synthetic fabrics			
 Extra Dry			•
 Cupboard Dry			•
 Iron Dry			•
 Easy Iron			•



Programmes <sup>1)</sup>			
 Duvet			•
 Delicates			•
 Wool	• <sup>2)</sup>	•	•
 Refresh			
 Time Drying	•		•
 Rapid			

1) Together with the programme you can set 1 or more options. To activate or deactivate them, press the related touchpad.

2) Only with the Drying Rack

## 7. SETTINGS

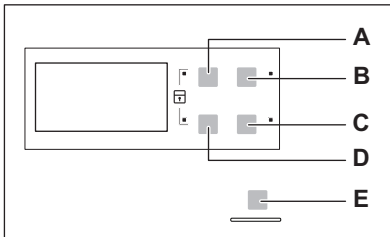

- A) Time  touchpad
- B) Delay  touchpad
- C) Delicate  touchpad
- D) Wool Load  touchpad
- E) Start/Pause  touchpad

### 7.1 Child lock function

This option prevents children to play with the appliance while a programme operates. The programme knob and the touchpads are locked. Only the on/off button is unlocked.

#### Activating the child lock option

1. Press the on/off button to activate the appliance.
2. Press and hold touchpads (A) and (D) at the same time until the child lock indicator comes on.
  - It is possible to deactivate the child lock option while a programme operates. Press and hold the same

touchpads until the child lock indicator goes off.



### 7.2 Buzzer on/off

To deactivate or activate the acoustic signals, press and hold touchpads (B) and (C) at the same time for approximately 2 seconds.

### 7.3 Water hardness and conductivity

Water hardness is different for different locations. Water hardness has an effect on the water conductivity and on the conductivity sensor of the appliance. If you know, the value of the water conductivity you can adjust the sensor in order to have better drying results.

#### Adjusting the conductivity sensor

1. Press the on/off button to activate the appliance
2. Press and hold touchpads (A) and (B) at the same time until one of the these indicators comes on:
  -  (low <300 µS/cm)
  -  (moderate 300-600 µS/cm)
  -  (high >600 µS/cm)
3. Press the touchpad (E) again and again until the indicator of the correct level comes on.

4. To confirm the adjustment, press and hold touchpads **(A)** and **(B)** at the

same time for approximately 2 seconds.

## 8. DAILY USE

### Before you use the appliance for the first time

1. Clean the appliance drum with a moist cloth.
2. Start a short programme (e.g. 30 minutes) with moist laundry.

### 8.1 Starting a programme without delay start

1. Prepare the laundry and load the appliance.
2. Press the on/off button to activate the appliance.
3. Set the correct programme and options for the type of load.
  - The display shows the programme duration.
4. Press the Start/Pause touchpad, the programme starts.



#### CAUTION!

Make sure that when you close the door, the laundry does not catch between the appliance door and the rubber seal.

### 8.2 Starting the programme with delay start



1. Set the correct programme and options for the type of load.
2. Press the delay start button again and again until the display shows the delay time you want to set.
  - You can delay the start of a programme from a minimum of 30 minutes to a maximum of 20 hours.
3. Press the Start/Pause touchpad, the countdown starts. The display shows the countdown of the delay start.
  - When the countdown is completed, the programme starts.

### 8.3 Change a programme

1. Press the on/off button to deactivate appliance
2. Press the on/off button to activate the appliance.
3. Set the programme.

### 8.4 At the end of the programme

When the programme is completed,



- An intermittent acoustic signal operates.
- The indicator  flashes.
- The indicator  comes on.
- The Start/Pause indicator is on.

The appliance continues to operate with the crease guard phase for approximately 30 minutes.

The crease guard phase removes creases from your laundry.

You can remove the laundry before the crease guard phase is completed. We recommend, for better results, that you remove the laundry when the phase is almost completed or completed.

When the crease guard phase is completed:

- The indicator  is on but does not flash.
- The indicator  goes off.
- Start/Pause indicator goes off.

1. Press the on/off button to deactivate the appliance.
2. Open the appliance door.
3. Remove the laundry.
4. Close the appliance door.



Always clean the filter and empty the water container when a programme is completed.

## 8.5 Auto STAND-BY function





To decrease the energy consumption, this function automatically deactivates the appliance:

- After 5 minutes if you do not start the programme.
- After 5 minutes from the end of the programme.

## 9. HINTS AND TIPS

### 9.1 Preparing the laundry

- Close the zippers.
- Close the fasteners of the duvet covers.
- Do not keep ties or ribbons loose (e.g. apron ribbons). Tie them before you start a programme.
- Remove all items from the pockets.
- If an item has the internal layer made of cotton, turn it inside out. Make sure that the cotton layer is always external.
- We recommend that you set the correct programme applicable for the type of fabrics that are in the appliance.
- Do not put fabrics with strong colours together with fabrics with light colours. Strong colours can bleed.
- Use an applicable programme for cotton jersey and knitwear to prevent the items shrinking.
- Make sure that the laundry weight is not more than the maximum weight that is in the programme table.
- Dry only the laundry that is applicable for tumble dryer. Refer to the fabric label on the items.

Fabric label	Description
	Laundry that is applicable for tumble dryer.
	Laundry that is applicable for tumble dryer. Set the programme with standard temperature.
	Laundry that is applicable for tumble dryer. Set the programme with low temperature.
	Laundry that is not applicable for tumble dryer.

## 10. CARE AND CLEANING

### 10.1 Cleaning the filter

1.

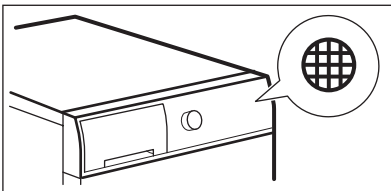

2.

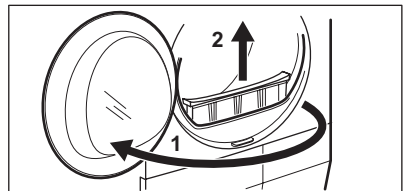

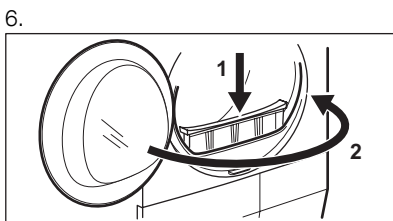
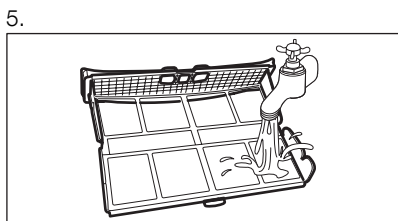
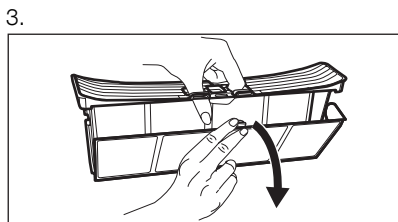

## 10.2 Draining the water container

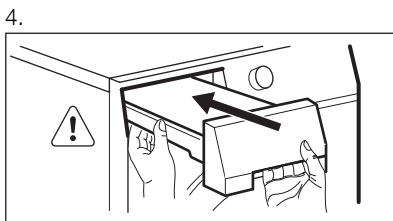
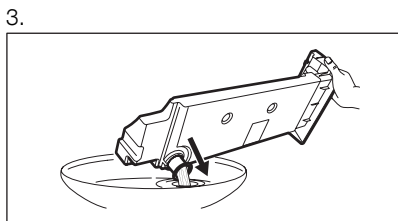
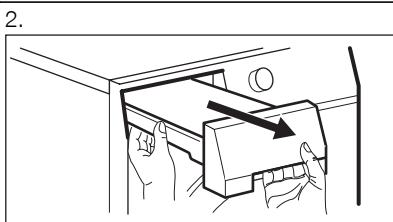
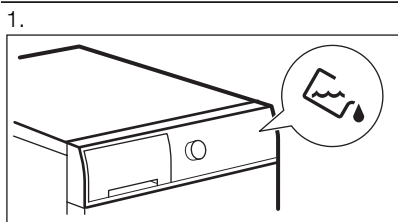

You can use the water from the water container as an alternative to distilled water (e.g. for steam ironing). Before you use the water, remove dirt residues with a filter.

### 10.3 Cleaning the condenser

1.

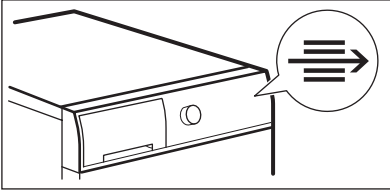

2.

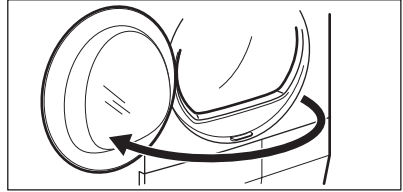

3.

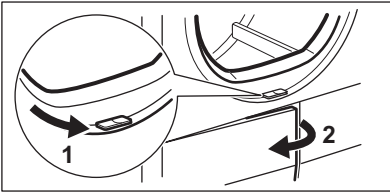

4.

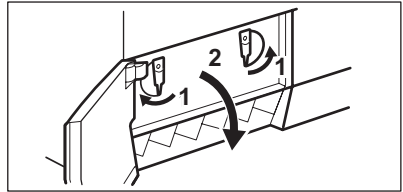

5.

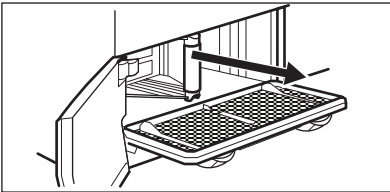

6.



7.

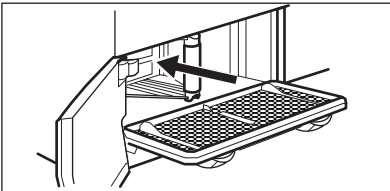

8.

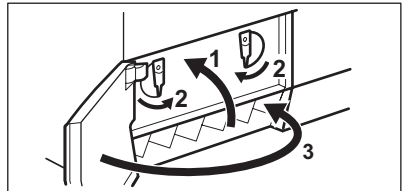

### 10.4 Cleaning the drum

Clean the drum with a moist cloth. Only use neutral detergents. Do not use abrasive products, abrasive cleaning pads or solvents.

Dry the drum with a soft cloth.

### 10.5 External Cleaning

Clean the appliance with a moist cloth. Only use neutral detergents. Do not use

abrasive products, abrasive cleaning pads or solvents.

Dry the appliance with a soft cloth.

### 10.6 Cleaning the airflow slots

Use a vacuum cleaner to remove the fluff from the airflow slots.

## 11. TROUBLESHOOTING

Problem	Possible solution
You cannot activate the appliance.	Make sure that the mains plug is connected to the mains socket.
	Check fuse in fuse box (domestic installation)
The programme does not start.	Press Start/Pause .
	Make sure that the appliance door is closed.
The appliance door does not close.	Make sure that the installation of the filter is correct.
	Make sure that the laundry does not catch between the appliance door and the rubber seal.
The appliance stops during operation.	Make sure that the water container is empty. Press Start/Pause to start the programme again.
The display shows a long programme duration. <sup>1)</sup>	Follow guide in program table depending on size and type of load
	Make sure that the filter is clean.
	The laundry is too wet. Spin the laundry in the washing machine again.
	Make sure that the room temperature is not too warm.
The display shows a short programme duration.	Set the Time Drying or the Extra Dry programme.
The display shows <b>Err.</b>	If you want to set a new programme, deactivate and activate the appliance.
	Make sure that the options are applicable to the programme.
The display shows <b>E51)</b>	Deactivate and activate the appliance. Start a new programme. If the problem occurs again, contact the Service.

<sup>1)</sup> After maximum 5 hours, the programme ends automatically

### 11.1 If the drying results are not satisfactory

- The set programme was incorrect.
- The filter is clogged.
- The condenser is clogged.
- There was too much laundry in the appliance.
- The drum is dirty.
- Incorrect setting of the conductivity sensor.
- The airflow slots are clogged.

## 12. TECHNICAL DATA

Dimensions (mm)	Width / Height / Depth	600 / 850 – 865 / 600
Max. depth (with the appliance door open)		1090 mm
Max. width (with the appliance door open)		950 mm
Electrical connection	Voltage	230-240 V
	Frequency	50 Hz
	Fuse	10 A
	Total power	2250 W
Drum volume		108 l
Weight of the appliance		41 kg
Laundry: max. weight		8 kg
Type of use		Household
Ambient temperature	Min.	5 °C
	Max.	35 °C
Power consumption	Left-on mode	0,48 W
	Off-mode	0,48 W

## 13. SERVICE

If there are technical faults, first check if you can remedy the problem yourself with the help of the operating instructions - see chapter *Troubleshooting*

If you cannot remedy the problem on your own, get in touch with the Customer Care Department or one of our service partners.

To assist you quickly, these data are necessary:

- Model description
- Product number (PNC)
- Serial number (S No. is on rating plate stuck to the product - to find it see chapter *Product description*))

- Type of failure

- Any error messages shown by the display.

So that you have the necessary reference numbers from your appliance at hand, we recommend that you write them in here:

Model description:	.....
PNC:	.....
S No:	.....

## 14. WARRANTY

FOR SALES IN AUSTRALIA AND NEW ZEALAND

APPLIANCE: ELECTROLUX DRYER

**This document sets out the terms and conditions of the product warranties for Electrolux Appliances. It is an important document. Please keep it with your proof of purchase documents in a safe place for future reference should you require service for your Appliance.**

1. In this warranty
  - a) 'acceptable quality' as referred to in clause 10 of this warranty has the same meaning referred to in the ACL;
  - b) 'ACL' means Trade Practices Amendment (Australian Consumer Law) Act (No.2) 2010;
  - c) 'Appliance' means any Electrolux product purchased by you accompanied by this document;
  - d) 'ASC' means Electrolux' authorised serviced centres;
  - e) 'Electrolux' means Electrolux Home Products Pty Ltd of 163 O'Riordan Street, Mascot, NSW 2020, ABN 51 004 762 341 in respect of Appliances purchased in Australia and Electrolux (NZ) Limited of 3-5 Niall Burgess Road, Mount Wellington, in respect of Appliances purchased in New Zealand;
  - f) 'major failure' as referred to in clause 10 of this warranty has the same meaning referred to in the ACL and includes a situation when an Appliance cannot be repaired or it is uneconomic for Electrolux, at its discretion, to repair an Appliance during the Warranty Period;
  - g) 'Warranty Period' means:
    - where the Appliance is used for personal, domestic or household use (i.e. normal single family use) as set out in the instruction manual, the Appliance is warranted against manufacturing defects in Australia for 24 months and in New Zealand for 24 months, following the date of original purchase of the Appliance;
    - where the Appliance is used for commercial purposes (including being used to directly assist a business or where the Appliance is used in a multi-family communal or share type environment), the Appliance will then be warranted against manufacturing defects in Australia for 3 months and in New Zealand for 3 months, following the date of original purchase of the Appliance.
  - h) 'you' means the purchaser of the Appliance not having purchased the Appliance for re-sale, and 'your' has a corresponding meaning.
2. This warranty only applies to Appliances purchased and used in Australia or New Zealand and is in addition to (and does not exclude, restrict, or modify in any way) any non-excludable statutory warranties in Australia or New Zealand.
3. During the Warranty Period Electrolux or its ASC will, at no extra charge if your Appliance is readily accessible for service, without special equipment and subject to these terms and conditions, repair or replace any parts which it considers to be defective. Electrolux or its ASC may use remanufactured parts to repair your Appliance. You agree that any replaced Appliances or parts become the property of Electrolux. This warranty does not apply to light globes, batteries, filters or similar perishable parts.
4. Parts and Appliances not supplied by Electrolux are not covered by this warranty.
5. You will bear the cost of transportation, travel and delivery of the Appliance to and from Electrolux or its ASC. If you reside outside of the service area, you will bear the cost of:
  - a) travel of an authorised representative;
  - b) transportation and delivery of the Appliance to and from Electrolux or its ASC,

In all instances, unless the Appliance is transported by Electrolux or an Electrolux authorised representative, the Appliance is transported at the



- owner's cost and risk while in transit to and from Electrolux or its ASC.
6. Proof of purchase is required before you can make a claim under this warranty.
  7. You may not make a claim under this warranty unless the defect claimed is due to faulty or defective parts or workmanship. Electrolux is not liable in the following situations (which are not exhaustive):
    - a) the Appliance is damaged by:
      - accident
      - misuse or abuse, including failure to properly maintain or service
      - normal wear and tear
      - power surges, electrical storm damage or incorrect power supply
      - incomplete or improper installation
      - incorrect, improper or inappropriate operation
      - insect or vermin infestation
      - failure to comply with any additional instructions supplied with the Appliance;
    - b) the Appliance is modified without authority from Electrolux in writing;
    - c) the Appliance's serial number or warranty seal has been removed or defaced;
    - d) the Appliance was serviced or repaired by anyone other than Electrolux, an authorised repairer or ASC.
  8. This warranty, the contract to which it relates and the relationship between you and Electrolux are governed by the law applicable where the Appliance was purchased. Where the Appliance was purchased in New Zealand for business purposes the Consumer Guarantee Act does not apply.
  9. To the extent permitted by law, Electrolux excludes all warranties and liabilities (other than as contained in this document) including liability for any loss or damage whether direct or indirect arising from your purchase, use or non use of the Appliance.
  10. For Appliances and services provided by Electrolux in Australia, the Appliances come with a guarantee by Electrolux that cannot be excluded under the Australian Consumer Law. You are entitled to a replacement or refund for a major failure and for compensation for any other reasonably foreseeable loss or damage. You are also entitled to have the Appliance repaired or replaced if the Appliance fails to be of acceptable quality and the failure does not amount to a major failure. The benefits to you given by this warranty are in addition to your other rights and remedies under a law in relation to the Appliances or services to which the warranty relates.
  11. At all times during the Warranty Period, Electrolux shall, at its discretion, determine whether repair, replacement or refund will apply if an Appliance has a valid warranty claim applicable to it.
  12. For Appliances and services provided by Electrolux in New Zealand, the Appliances come with a guarantee by Electrolux pursuant to the provisions of the Consumer Guarantees Act, the Sale of Goods Act and the Fair Trading Act.
  13. To enquire about claiming under this warranty, please follow these steps:
    - a) carefully check the operating instructions, user manual and the terms of this warranty;
    - b) have the model and serial number of the Appliance available;
    - c) have the proof of purchase (eg an invoice) available;
    - d) telephone the numbers shown below.
  14. You accept that if you make a warranty claim, Electrolux and its ASC may exchange information in relation to you to enable Electrolux to meet its obligations under this warranty.

Before calling for service, please ensure that the steps listed in point 13 above have been followed.

**FOR SERVICE**

or to find the address of your nearest state service centre in Australia

**Please call 13 13 4 9**

For the cost of a local call (Australia only)

**SERVICE AUSTRALIA**

 **Electrolux**  
**ELECTROLUX HOME PRODUCTS**

[www.electrolux.com.au](http://www.electrolux.com.au)

**FOR SPARE PARTS**

or to find the address of your nearest state spare parts centre in Australia

**Please call 13 13 50**

For the cost of a local call (Australia only)

**FOR SERVICE**

or to find the address of your nearest authorised service centre in New Zealand

**Free call 0800 10 66 10**

(New Zealand only)

**SERVICE NEW ZEALAND**

 **Electrolux**  
**ELECTROLUX HOME PRODUCTS**

[www.electrolux.co.nz](http://www.electrolux.co.nz)

**FOR SPARE PARTS**

or to find the address of your nearest state spare parts centre in New Zealand

**Free call 0800 10 66 20**

(New Zealand only)

## 15. ENVIRONMENT CONCERNS

Recycle the materials with the symbol 

. Put the packaging in applicable containers to recycle it.

Help protect the environment and human health and to recycle waste of electrical

and electronic appliances. Do not dispose appliances marked with the symbol 

with the household waste. Return the product to your local recycling facility or contact your municipal office.



