

EN USER MANUAL
DE BENUTZERHANDBUCH
FR MANUEL D'INSTRUCTIONS



Hob²Hood

It is an advanced automatic function which connects the hob to a special hood. Both the hob and the hood have an infra — red signal communicator.

Speed of the fan is defined automatically on basis of mode setting and temperature of the hottest cookware on the hob. You can also operate the fan from the hob manually.

i For most of the hoods the remote system is originally deactivated. Activate it before you use the function.



When you operate the appliance with the function:

- Protect the hood panel from direct sunlight.
- Do not spot halogen light on the hood panel.
- Do not cover the hob panel (eg. Hand or pan handle).

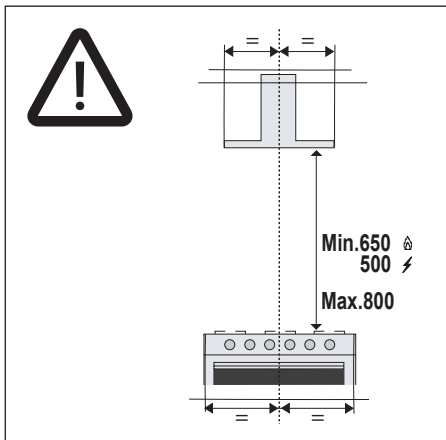

Model of the hood

X79263MK1

X89463MD02

X69453MD02

X69454MD10

X76263MK10

X79263MK10

X69454MD10H

ERIC931SA

ERC930SA

Receiver activation



Model of the hood	
X79263MK1	
X76263MK10	
X79263MK10	



ⓘ	-	+	8.8	☘	☘ _{min}	☘
A	B	C		D	E	F

Button	Function	Led
A	If pressed and held for 5 seconds with the hood and light turned off and no alarm, do: Enables the Remote control.	Display "IR" and the Dot flashing twice.
	Disables the Remote control.	Display "IR" and the Dot flashing just once



Model of the hood	
X89463MD02	X69454MD10H
X69453MD02	ERC1931SA
X69454MD10	ERC930SA

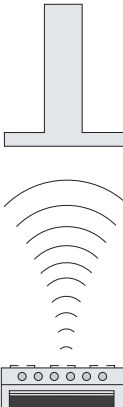

☘	ⓘ	☘	☘	☘	☘	⌚	🌐
LIGHT	ON/OFF	LOW	MEDIUM	HIGH	BOOST	TIMER	FILTER
A	B	C	D	E	F	G	H

☘	ⓘ	☘ ₁	☘ ₂	☘ ₃	☘	⌚	F/C
A	B	C	D	E	F	G	H

Button	Function	Led
G	If pressed and held for 5 seconds with the hood and light turned off and no alarm, do: Enables the Remote control.	2 Flashes Led button C + B
	Disables the Remote control.	1 Flash Led button C + B

Abzugshauben mit Hob²Hood Funktion

Dabei handelt es sich um eine innovative Automatikfunktion, die die Verbindung des Kochfelds mit einer Spezial-Abzugshaube ermöglicht. Kochfeld und Haube funktionieren mit einem Infrarot-Sender.

Die Lüftergeschwindigkeit wird je nach Einstellung und Temperatur des Kochgeschirrs auf dem Kochfeld automatisch reguliert. Der Lüfter kann auch über das Kochfeld von Hand bedient werden.

i Bei den meisten Abzugshauben ist die Fernbedienung von Haus aus deaktiviert. Bevor also diese Funktion genutzt wird, muss sie aktiviert werden.

i Wenn das Gerät mit dieser Funktion genutzt wird:

- Das Bedienfeld der Abzugshaube gegen direkte Sonneneinstrahlung schützen.
- Keine Halogenspots auf das Bedienfeld der Abzugshaube richten.
- Das Bedienfeld des Kochfelds nicht verdecken (z.B. mit der Hand oder einem Pfannenstiel).

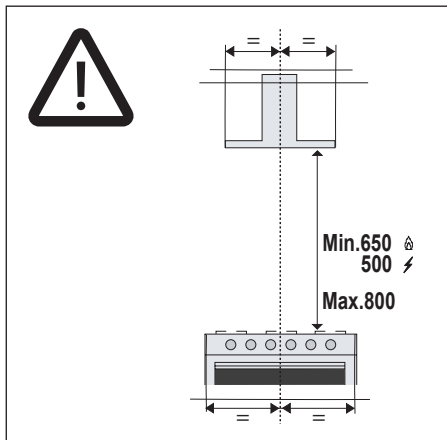

Modell der Abzugshaube





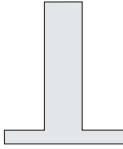

X79263MK1
X89463MD02
X69453MD02
X69454MD10
X76263MK10
X79263MK10
X69454MD10H
ERCI931SA
ERC930SA

Aktivierung des empfängers



Modell der Abzugshaube	
X79263MK1	
X76263MK10	
X79263MK10	



						
A	B	C		D	E	F

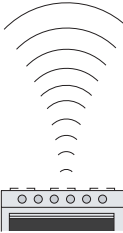







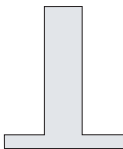

Taste	Funktion	Led
A	Mit 5 Sekunden langem Drücken bei ausgeschalteter Abzugshaube und Beleuchtung und ohne Alarm, wird: Die Fernbedienung aktiviert.	Display "IR" und der Punkt blinken zwei Mal.
	Die Fernbedienung deaktiviert.	Display "IR" und der Punkt blinken nur einmal.









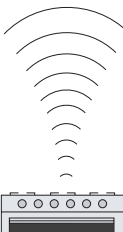

Modell der Abzugshaube	
X89463MD02	X69454MD10H
X69453MD02	ERC1931SA
X69454MD10	ERC930SA



							
LIGHT	ON/OFF	LOW	MEDIUM	HIGH	BOOST	TIMER	FILTER
A	B	C	D	E	F	G	H



							
A	B	C	D	E	F	G	H

Taste	Funktion	Led
G	Mit 5 Sekunden langem Drücken bei ausgeschalteter Abzugshaube und Beleuchtung und ohne Alarm, wird: Die Fernbedienung aktiviert.	2 mal Blinken LED Taste C + B.
	Die Fernbedienung deaktiviert.	1 mal Blinken LED Taste C + B.

Hotte Hob²Hood

Il s'agit d'une fonction automatique avancée qui raccorde la plaque de cuisson à une hotte spéciale. Un dispositif de communication à signal infrarouge est installé sur la plaque et sur la hotte.

La vitesse de ventilation est automatiquement définie en fonction des paramétrages et la température de la casserole la plus chaude sur la plaque de cuisson. Le ventilateur peut également être utilisé en mode manuel à partir de la plaque de cuisson.

i Au départ, la télécommande est désactivée pour la plupart des hottes. Activez-la avant d'utiliser cette fonction.

i Lorsque vous utilisez l'appareil avec la fonction:

- Protégez le panneau de la hotte contre la lumière directe du soleil.
- Ne pointez pas de lumière halogène sur le panneau de la hotte.
- Ne couvrez pas le panneau de la plaque de cuisson (par ex., main ou poignée de casserole).

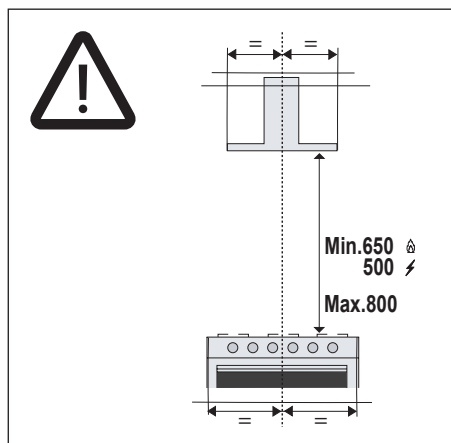

Modèle de hotte
X79263MK1
X89463MD02
X69453MD02
X69454MD10
X76263MK10
X79263MK10
X69454MD10H
ERCI931SA
ERC930SA

Activation du récepteur



Modèle de hotte
X79263MK1
X76263MK10
X79263MK10

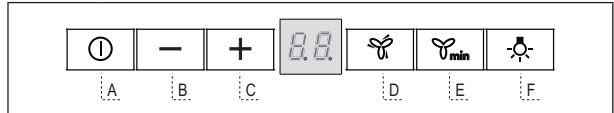
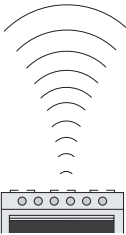
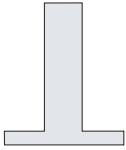

Bouton	Fonction	Led
A	Si appuyé pendant 5 secondes tandis que la hotte et le voyant sont éteints et en l'absence d'alarme: - active la télécommande; - désactive la télécommande.	«IR» s'affiche et le point clignote deux fois. «IR» s'affiche et le point clignote une fois seulement.



Modèle de hotte	
X89463MD02	X69454MD10H
X69453MD02	ERC1931SA
X69454MD10	ERC930SA

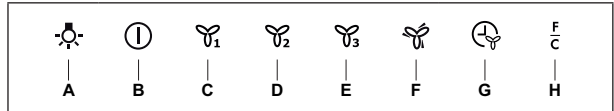
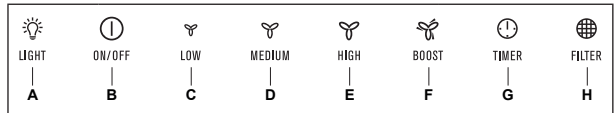
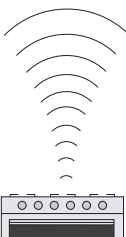
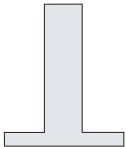

Bouton	Fonction	Led
G	Si appuyé pendant 5 secondes tandis que la hotte et le voyant sont éteints et en l'absence d'alarme: - active la télécommande; - désactive la télécommande.	La LED C + B clignote 2 fois. La LED C + B clignote 1 fois.

