

EVE614, EVE616,  
EVE626, EVE636,  
EVEP614, EVEP616, EVEP618, EVEP626

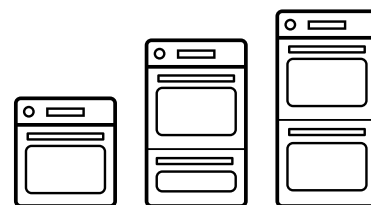

---

Cooking

---

User manual

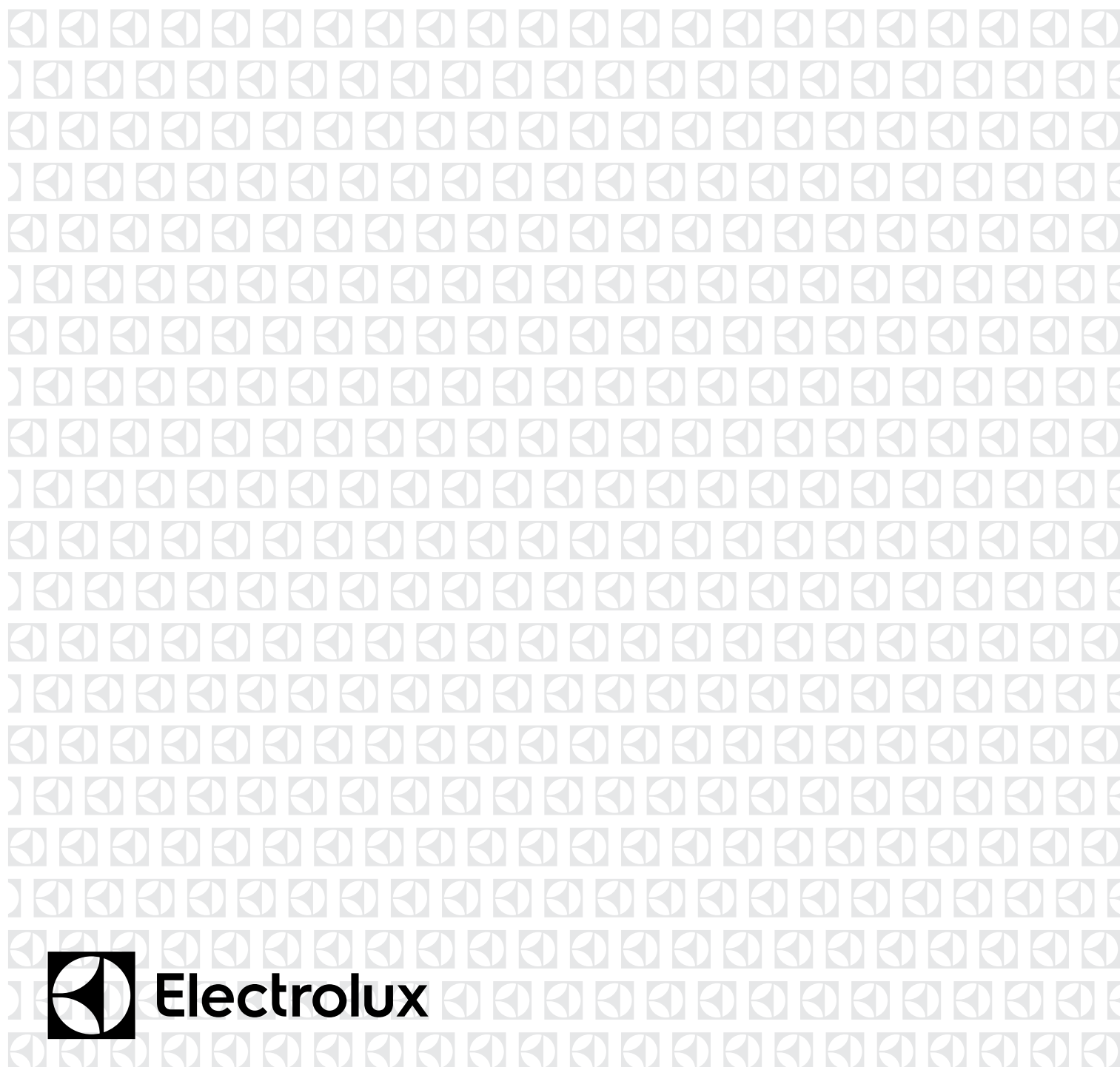

## CONGRATULATIONS

Dear customer,

Thank you for purchasing an Electrolux oven. You've chosen a product that brings with it decades of professional experience and innovation. Ingenious and stylish, it has been designed with you in mind. So whenever you use it, you can be safe in the knowledge that you'll get great results every time.

Welcome to Electrolux.

The symbols you will see in this booklet have these meanings:



### WARNING

**This symbol indicates information concerning your personal safety.**



### CAUTION

**This symbol indicates information on how to avoid damaging the cooker or cabinet.**



### IMPORTANT

**This symbol indicates tips and information about use of the cooker.**



### ENVIRONMENT

**This symbol indicates tips and information about economical and ecological use of the cooker.**

*NOTE: Model codes shown in this manual are the generic code. Your product will also include a two letter suffix which denotes colour and series level.*

## CONDITIONS OF USE

This appliance is intended to be used in household and similar applications such as:

- Staff kitchen areas in shops, offices and other working environments
- Farm houses
- By clients in hotels, motels and other residential type environments
- Bed and breakfast type environments
- Catering and similar non-retail applications

Record model and serial number here:

Model number: \_\_\_\_\_

Serial number: \_\_\_\_\_

## CONTENTS

Important instructions _____	3
Before using your appliance _____	3
Information on disposal for users _____	3
Important safety instructions _____	3
General cautions _____	4
Installing the oven accessories _____	5
Using the appliance _____	6
EVE614 _____	7
Before using the appliance _____	8
Cooking functions _____	9
Operating sequence _____	10
Using the appliance _____	10
EVEP614 _____	12
Before using the appliance _____	13
Cooking functions _____	14
Operating sequence _____	15
Using the appliance _____	15
Pyrolytic cleaning of the oven _____	18
EVE616 _____	19
EVE626, EVE636 _____	20
Before using the appliance _____	21
Cooking functions _____	22
Operating sequence _____	24
Using the appliance _____	25
Additional functionality _____	27
EVEP616, EVEP618 _____	29
EVEP626 _____	30
Before using the appliance _____	31
Cooking functions _____	32
Operating sequence _____	34
Using the appliance _____	35
Additional functionality _____	37
Cleaning the oven _____	38
Cleaning the steam parts (EVEP618) _____	38
Pyrolytic cleaning of the oven _____	38
Getting to know the oven _____	40
Steam assisted cooking _____	42
Using the food probe _____	45
Cooking guide _____	48
Dealing with cooking problems _____	52
Cleaning the appliance _____	53
Cleaning the accessories _____	54
Cleaning the triple glazed oven door _____	55
Cleaning the quad glazed oven door _____	57
Tips and troubleshooting _____	59
Installation of the appliance _____	61
Technical specifications _____	63
Warranty _____	67

# IMPORTANT INSTRUCTIONS

## Important Information that may impact your Manufacturer's Warranty

Adherence to the directions for use in this manual is extremely important for health and safety. Failure to strictly adhere to the requirements in this manual may result in personal injury, property damage and affect your ability to make a claim under the Electrolux manufacturer's warranty provided with your product. Products must be used, installed and operated in accordance with this manual. You may not be able to claim on the Electrolux manufacturer's warranty in the event that your product fault is due to failure to adhere to this manual.

## BEFORE USING YOUR APPLIANCE

Before you use the appliance, we recommend that you read through the relevant sections of this manual, which provides the description of your appliance and its functions.

To avoid the risks that are always present when you use an appliance, it is important that the appliance is installed correctly and that you read the safety instructions carefully to avoid misuse and hazards.

We recommend that you keep this instruction booklet for future reference and pass it on to any future owners.

This appliance complies with the requirements of Australian Standards AS/NZS 60335.2.6

## IMPORTANT

**Check for any damage or marks. If you find the appliance is damaged or marked, you must report it within 7 days if you wish to claim for damage/marks under the manufacturer's warranty. This does not affect your statutory rights.**

### Preparing the oven

1. Please remove all stickers and protective film from doors and control panel, and remove all leaflets and boxes from the floor of the oven before operation.
2. Please wipe out the oven interior prior to operation with warm soapy water and polish dry with a soft clean cloth. Do not close the oven door until the oven is completely dry.
3. Do not line the oven with foil. It will damage the enamel.
4. For model EVEP618, check the water drawer interior for dust or contaminates. Wipe clean with a damp cloth if necessary.

## IMPORTANT

**New appliances can have a smell during first use. It is recommended to 'run in' the oven before cooking for the first time. Operate the oven, empty, at a temperature of 180°C for approximately 30 minutes.**

**Please ensure the room is well ventilated during this process.**

## INFORMATION ON DISPOSAL FOR USERS

## ENVIRONMENT

**Most of the packing materials are recyclable. Please dispose of those materials through your local recycling depot or by placing them in appropriate collection containers.**

**If you wish to discard this appliance, please contact your local authorities and ask for the correct method of disposal.**

## IMPORTANT SAFETY INSTRUCTIONS

## WARNING

**These warnings have been provided in the interest of safety. You MUST read them carefully before installing or using the appliance.**

- An authorised person must install this appliance. (Certificate of Compliance to be retained).
- Before using the appliance, ensure that all packing materials are removed from the appliance.
- In order to avoid any potential hazard, the enclosed installation instructions must be followed.
- Ensure that all specified vents, openings and air spaces are not blocked.
- Where the appliance is built into a cabinet, the cabinet material must be capable of withstanding 70°C. If adjacent to vinyl-wrapped surfaces, use installation kit from vinyl wrap supplier.
- Only authorised personnel should carry out servicing. (Certificate of Compliance to be retained)
- Always ensure the appliance is switched off before cleaning or replacing parts.
- For model EVEP618, do not open the oven door during steam cooking. Steam can be released. There is a risk of skin burns. There is a risk that steam causes moisture damage to cabinets.

# IMPORTANT INSTRUCTIONS (CONTINUED)

- Allow the oven to cool down for 30 minutes before you drain the water tank in a steam oven. Scalding water may be released.
- In order to avoid fire, the appliance must be kept clean and vents kept unobstructed.
- Do not spray flammable materials in or under the appliance, e.g. aerosols.
- Always use gloves when handling hot items inside the oven.
- Always turn the grill off immediately after use as fat left behind may catch fire.
- Do not cover the grill dish insert with foil, as fat left there may catch fire.
- Always keep the grill dish clean as any fat residue may catch fire.
- Do not leave the grill on unattended.
- To avoid fire, ensure that the grill trays and fittings are always inserted into the appliance in accordance with the instructions.
- To avoid any electric shock, switch the appliance off before removing the oven light glass for globe replacement.
- To avoid an accident, ensure that the oven shelves and fittings are always inserted into the appliance in accordance with the instructions.
- This appliance must be earthed.

*NOTE: The cooking process must be supervised. A short term cooking process has to be supervised continuously.*

## Child safety

This appliance is not intended for use by persons (including children) with reduced physical, sensory or mental capabilities, or lack of experience and knowledge, unless they have been given supervision or instruction concerning use of the appliance by a person responsible for their safety.

- Children should be supervised to ensure that they do not play with the appliance.
- During use this appliance becomes hot. Care should be taken to avoid touching hot surfaces, e.g. oven door, heating elements.
- Accessible parts will also become hot when in use. To avoid burns and scalds children should be kept away.

## GENERAL CAUTIONS

Read the following carefully to avoid damage or injury.

It is important to use the appliance safely.

Check these safety points before using the appliance.

- This appliance must not be used as a space heater.
- Do not place thick portions of food under the grill. Foods may curl, catch and ignite.
- Do not use the door as a shelf.
- Do not push down on the open oven door.
- Do not use harsh abrasive cleaners or sharp metal scrapers to clean the oven door glass since they can scratch the surface, and may result in shattering of the glass.
- Do not use steam cleaners, as this may cause moisture build-up.
- Always clean the appliance immediately after any food spills.
- Only use the Food Probe recommended for this appliance or the correct replacement parts (selected models only).



### WARNING

**To maintain safe operation, it is recommended that the product be inspected every five years by an authorised service person.**



### ENVIRONMENT

**To save energy and to help protect the environment, we recommend these hints:**

- Use the oven efficiently, by cooking many trays of food at the same time. Cook 2 trays of scones, small cakes or sausage rolls at the same time.
- Select the correct shelf location for food being cooked.
- Do not open the oven door more than necessary.

*NOTE: You must read these warnings carefully before installing or using the appliance. If you need assistance, contact your Customer Care Centre. The manufacturer will not accept liability, should these instructions or any other safety instructions incorporated in this book be ignored.*

## INSTALLING THE OVEN ACCESSORIES

### Slides (Telescopic runners)

1. Obtain left hand side rack and left hand side – see image to identify.

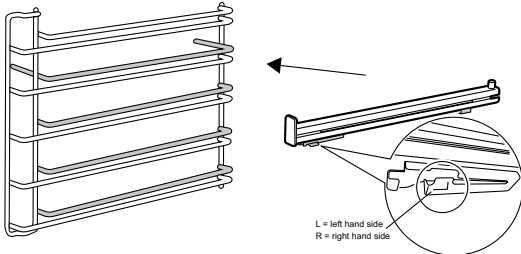

2. The shaded wires indicate the wire the slide can be mounted on. Fit slide rear clips to the rear of wire at an angle as shown below.

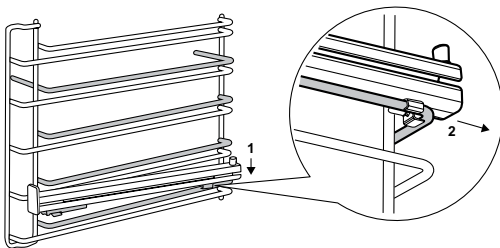

3. Push slide front clip over wire until secured

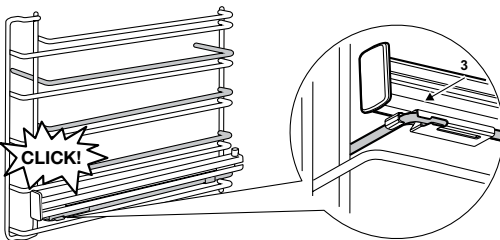

### Side racks

1. Insert the rear peg into the rear access hole provided, ensuring peg is fully inserted.
2. Then locate the front peg into the front access hole and push in firmly.

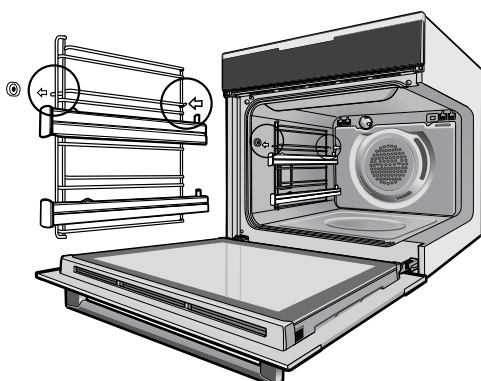

*NOTE: If you have purchased a two cavity appliance you will have additional side racks for the lower oven/grill. These are fitted in a similar manner.*

### Shelves

The shelves are designed so that they have maximum extension but cannot be accidentally pulled right out.

To fit a shelf to side racks:

*NOTE: To Locate the rear edge of the shelves, the detents on the side wires should be towards the oven back wall. See image.*

1. Rest the rear edge of the shelf on the lower guide rail of the side rack - see diagram. Ensure the same rail positions on both sides of the oven are being engaged.
2. With the front edge raised, begin to slide the shelf in between the guide rails of the side rack.
3. Once the detents have passed the front edge of the side rack, the shelf can be pushed fully in.

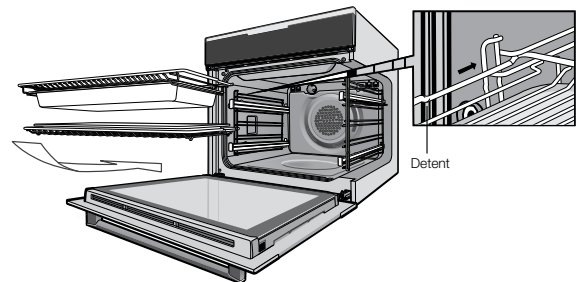

4. When fully inserted the shelf should not interfere with the closed oven door.

To fit a shelf or tray to telescopic slides:

1. Push the shelf or tray along the top of the slide until it hits the back post.

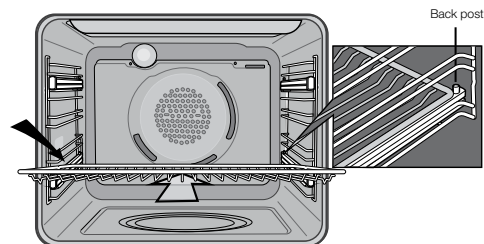

2. Drop the front of the shelf or tray onto the slide ensuring it sits behind the front post of the slide.

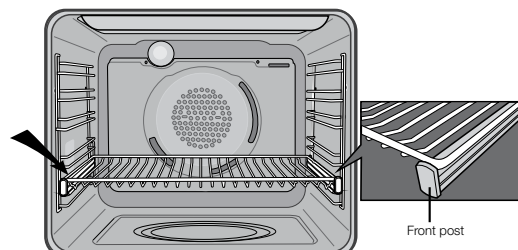

3. When fully inserted the shelf/tray should not interfere with the closed oven door.

# IMPORTANT INSTRUCTIONS (CONTINUED)

The appliance is supplied with two types of shelves

1. Standard shelf
2. Grill shelf -The tray can be suspended under the grill shelf to catch dripping fat. Rest the tray on two side rails of the grill shelf and push all the way in. Once the tray is pushed in fully it should sit inside the side rails.

## Trays

The appliance is supplied with Baking tray, Roasting tray and on selected models Cast roasting tray.

The baking tray and roasting tray can be placed on top of the shelves or can be suspended under the grill shelf.

Grill shelf and Roasting tray

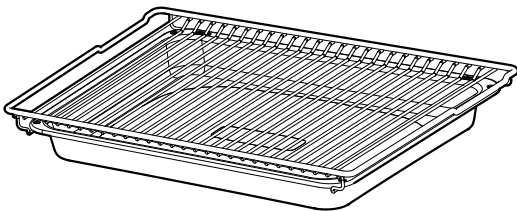

Baking tray

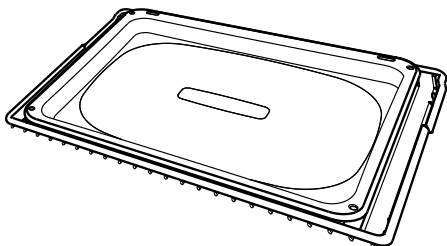

Cast roasting tray

The Cast roasting tray can be inserted between rack wires or can be fitted on telescopic slides.

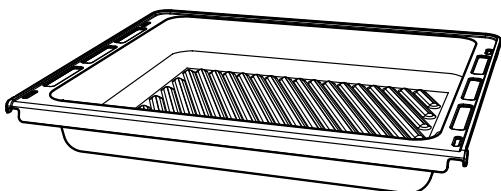

## USING THE APPLIANCE

### **i** IMPORTANT

#### Pre-heating

For best cooking results pre-heat the oven.

Pre-heating allows the oven to reach the required temperature quickly and efficiently as well as cook food at the correct temperature for the entire cook time.

1. With 'Rapid Heat' function

This function allows the oven to reach preset temperature quicker than any other cooking function.

Turn the function selector to 'Rapid Heat', then set the desired temperature, by rotating the oven temperature selector.

When the heating light goes out, the oven has reached the desired temperature. Select the oven function required and place the food in the oven.

2. With other oven functions

Set the desired temperature. Once the oven has reached the desired preset temperature, place your food in the oven, close the door and set the timer if you desire.

3. With 'Grill' function

Pre-heat the grill for at least 3 minutes to obtain best results. This will help to seal the natural juices of steak, chops and other meats for a better flavour.

### **i** IMPORTANT

#### Cooling / Ventilation fan

The built-in appliance is fitted with a cooling fan.

This prevents the kitchen cabinet from overheating and reduces the condensation inside the oven. It will operate whenever the oven is in use and blow warm air across the top of the oven door.

#### Condensation

Excess condensation may fog the oven door. This may happen when cooking large quantities of food from a cold start. Minimise condensation by:

- Keeping the amount of water used whilst cooking to a minimum.
- Making sure the oven door is firmly closed.
- Baking custard in a baking dish that is slightly smaller than the water container.
- Cooking casseroles with the lid on.

*NOTE: If using water in cooking, this will turn to steam and may condense outside your appliance. This is not a problem or fault with your oven.*

# EVE614

## COMPONENTS

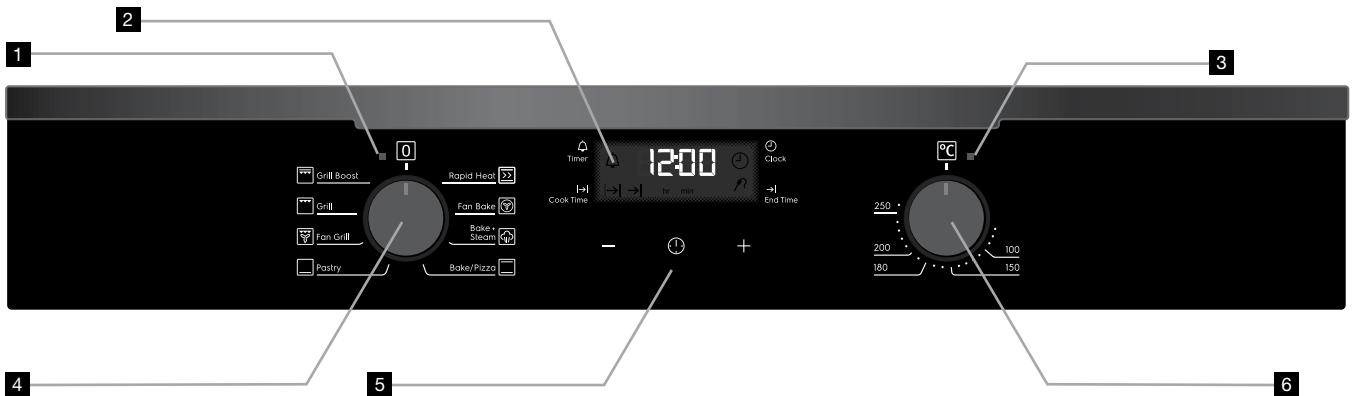

- |                          |                                    |
|--------------------------|------------------------------------|
| <b>1</b> Oven 'ON' light | <b>4</b> Function selector knob    |
| <b>2</b> Timer display   | <b>5</b> Touch pad                 |
| <b>3</b> 'Heating' light | <b>6</b> Temperature selector knob |

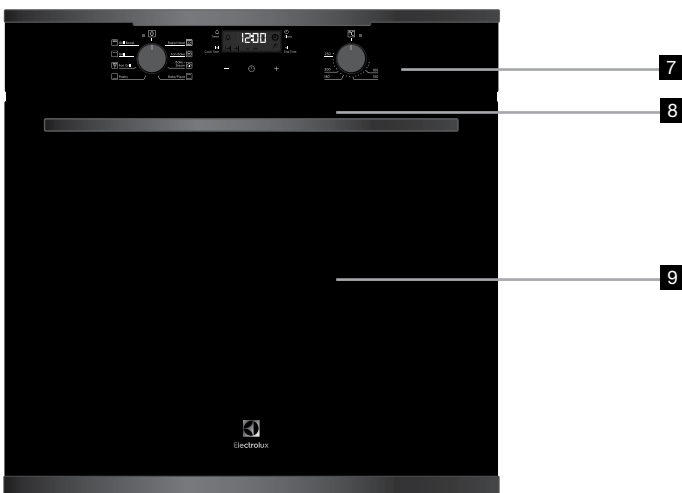

### EVE614

- |                           |                             |
|---------------------------|-----------------------------|
| <b>7</b> Control panel    | <b>9</b> Triple glazed door |
| <b>8</b> Warm air exhaust |                             |

# EVE614 (CONTINUED)

## BEFORE USING THE APPLIANCE

### Setting the time

Before the appliance can be used, the time must be set.

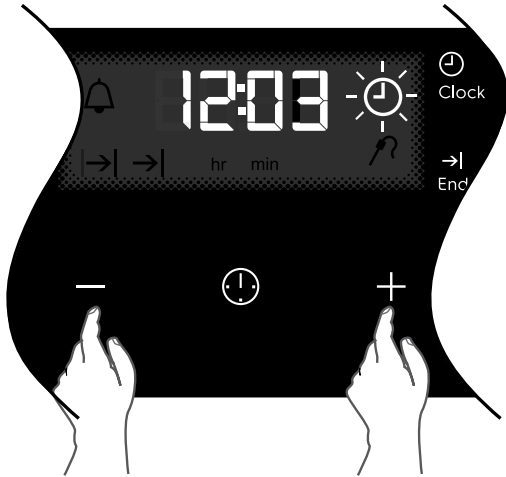

After the appliance has been electrically connected '12:00' will be displayed and the  clock icon will flash.

To set the time of day in hours and minutes touch the **+** or **-** symbols. Refer to the diagram above.









5 seconds after the last change, the clock symbol will disappear, confirming the time has been set.

Once the time has been entered, the clock advances minute by minute.

*NOTE: The clock has a 24 hour display.*



## COOKING FUNCTIONS

Symbol	Function description
<b>Rapid Heat</b> 	<p>Heat comes from the element surrounding the fan as well as the smaller element above the food. This allows you to preheat your oven 30% quicker than on standard 'Bake/Pizza'. 'Rapid Heat' is ideal for cooking frozen pre-cooked foods such as savoury pastries, pizzas, mini meals (TV dinners), meat pies and fruit pies. Simply place the food in the oven straight from the freezer and heat. Cook in the upper half of the oven for best results.</p>
<b>Fan Bake</b> 	<p>Heat comes from the element surrounding the fan. This fan circulates the hot air around the oven cavity so that you can put your food in different places in the oven and still cook them at the same time. You can use 'Fan Bake' function for multi-shelf cooking, reheating cooked foods, pastries and complete oven meals. It will cook at a lower temperature and be faster than baking. Please note that some variation in browning is normal.</p>
<b>Bake + Steam</b> 	<p>Bake + Steam adds humidity at the beginning of the baking process. In bakery products, this allows the dough to rise and helps create a moist interior while obtaining a golden and crispy crust. Before preheating, when the oven is cold, add water to the cavity well. Refer to chapter 'Steam assisted cooking' for more details. For best results preheat the empty oven for 10 minutes prior to inserting food.</p>
<b>Bake/pizza</b> 	<p>Heat comes from two elements, one above and one below the food. The bottom element is a clean heat element and is below the floor of the oven. Both elements are controlled by the thermostat and will turn on and off to maintain set temperature. You can use the 'Bake/pizza' function for single trays of biscuits, scones, muffins, cakes, slices, casseroles, baked puddings, roasts and delicate egg dishes.</p>
<b>Pastry</b> 	<p>Heat comes from the clean heat element below the food. The element is controlled by the thermostat and will turn on and off to maintain the set temperature. The 'Pastry' function can be used to add extra browning to the bases of pizzas, pies, and pastries. Cook in the lower half of the oven when you are using only one shelf.</p>
<b>Fan Grill</b> 	<p>'Fan Grill' offers you the benefits of both 'Fan Cook' and traditional 'Grill' functions. The grill element turns on and off to maintain set temperature while the fan circulates the heated air.</p> <p><b>Fan grill with the oven door closed.</b></p> <p>You can use 'Fan Grill' for large cuts of meat, which gives you a result that is similar to 'roisserie' cooked meat. Put your food on the grill shelf in position 2. Place the grill dish under the grill shelf to catch any spills. When using 'Fan Grill' it is not necessary to turn food over during the cooking cycle. Set temperature to 180°C.</p>
<b>Grill</b> 	<p>'Grill' function directs radiant heat from the powerful upper element onto the food. You can use the 'Grill' function for tender cuts of meat, steak, chops, sausages, fish, cheese toasties and other quick cooking foods.</p> <p><b>Grill with the oven door closed.</b></p> <p>Preheat your grill for 3 minutes to get the best results. This will help seal in the natural juices of steak, chops etc for better flavour. Place grill shelf in position 4 with grill dish below to catch any spills.</p>
<b>Grill Boost</b> 	<p>'Grill Boost' directs radiant heat from 2 powerful upper elements onto the food. You can use the 'Grill Boost' function for tender cuts of meat, steak, chops, sausages, fish, cheese toasties and other quick cooking foods.</p> <p><b>Grill with the oven door closed.</b></p> <p>'Grill Boost' allows you to take full advantage of the large grill dish area and will cook faster than normal 'Grill'. For best results it is recommended to preheat your grill for 3 minutes. This will help seal in the natural juices of steak, chops etc for a better flavour. Place grill shelf in position 4 with grill dish below to catch any spills.</p>

# EVE614 (CONTINUED)

## OPERATING SEQUENCE

### Select the cooking function

Turn the function selector in any direction to the desired cooking function. The oven cavity light will come on.

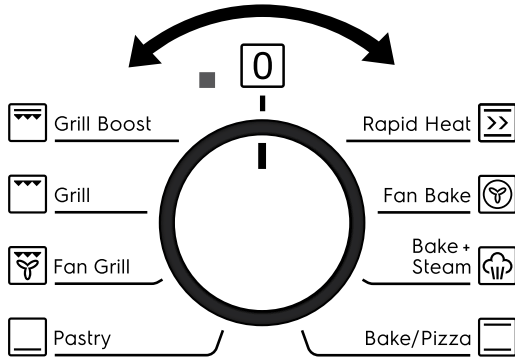

### Select the temperature

To set the temperature, turn the temperature selector in a clockwise direction to the desired setting. An indicator light in the display will come on.

A thermostat controls the temperature in your oven. When the temperature is reached, the heating source switches itself off and the indicator light goes out. When the oven temperature falls below the desired setting, the heating source switches on and the indicator light comes on again.

Once the food is cooked, turn the temperature selector back in an anti-clockwise direction. Do not force it right round in a clockwise direction as this will result in damage to the thermostat.

*NOTE: The desired cooking function must be selected before the oven will operate.*

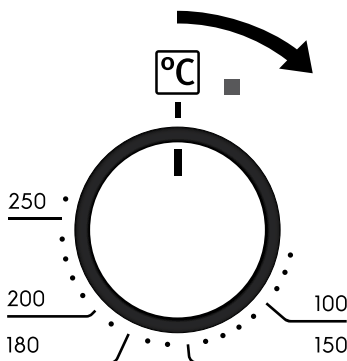

## USING THE APPLIANCE

### Cooking with the timer

The appliance is equipped with a timer that has the following features:

- Timer - sets a countdown time that will beep when the set time has elapsed.
- Cook time - sets cooking duration. A timer will count down the preset cooking time, beep when the time has elapsed and turn the appliance off.
- End time - instead of setting a cooking duration, a cooking finish time can be set. When the finish time has been reached the timer will beep and turn the appliance off.
- Delayed start cooking time - combines the cooking time and end cooking time to switch oven on and off at a specific time during the day.

### Selecting the timer

- Touch the MODE symbol until the timer  icon begins flashing.
- Set the countdown time you want by using the **+** and **-** symbols. 5 seconds after the last change the timer icon will stop flashing and the countdown will start in minutes.
- To stop the beeper, touch any symbol.
- Maximum countdown time is 2hrs 30mins.

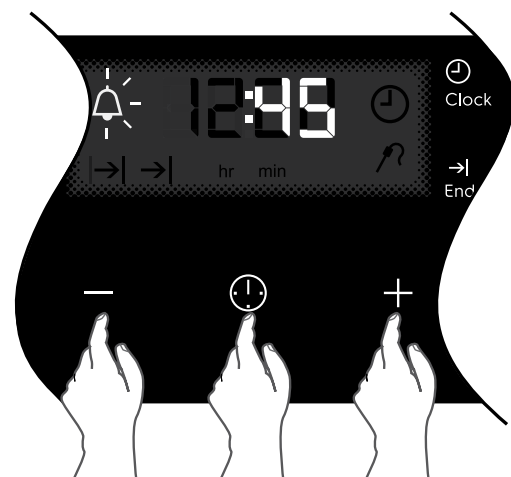

### Setting the cooking duration

- Select the desired oven function and temperature.
- The oven indicator light will glow and the heating source will come on.
- Touch the MODE symbol until the cook time icon  begins flashing.
- Set the cooking duration you want by using the **+** and **-** symbols. Five seconds after the last change the cook time icon will stop flashing, and the time of

day will be displayed. The oven will automatically shut off once the set duration is reached. To check how much time remains, press MODE until the cook time icon is lit. The remaining time will be displayed.

- When the oven shuts off an alarm will beep. To stop the beeper, touch any symbol.

**NOTE:** Remember to add pre-heating time if necessary.

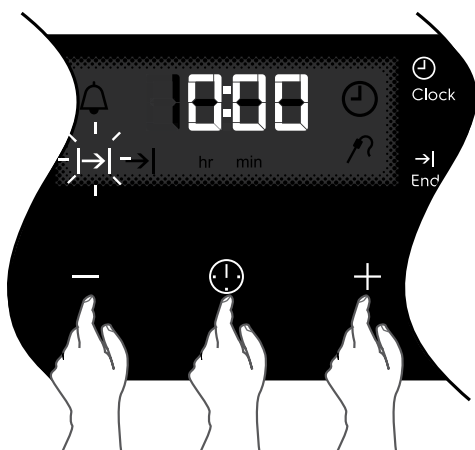

### Setting the cooking end time

Check that the clock displays the correct time of day.

Select the desired oven function and temperature. The oven indicator light will glow and the heating source will come on.

Touch the MODE symbol until the end time →| icon begins flashing.

Enter the time of day you want the cooking to finish by using the + and - symbols. Five seconds after the last change, the end time icon will stop flashing and the current time will be displayed.

**NOTE:** To stop the beeper, touch any symbol.

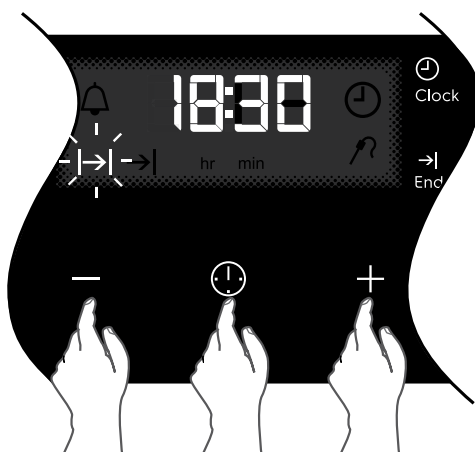

### Setting the delayed start cooking time

- Set the cook time and end time as described in the previous sections.
- Once both the cook time and end time have been set, both icons will stop flashing and the current time will be displayed.

To check or cancel settings:

- To check settings, touch the MODE symbol until the desired setting is displayed. The relevant icon will flash.

To cancel 'delayed start' touch the MODE symbol until the end time →| icon flashes. Touch and hold the - symbol until the clock no longer reverses (a beep will be heard). If temperature and function knobs are still at a setting, the oven will start once the end time →| icon stops flashing.

- To cancel 'auto shut off' touch the MODE symbol until the cook time |→| icon flashes. Touch and hold the - button until the clock no longer reverses (at 0:00 a beep will be heard). This automatically cancels 'auto shut off'. If the temperature and function knobs are still at a setting, the oven will start once the cook time |→| icon stops flashing. Because 'auto off' is cancelled the oven will continue to heat until it is manually turned off.

### On completion of cooking

The heat source will turn off, the timer will beep and the end time and/or cook time icons will flash.

Even though the heating element turns off the oven will still retain substantial heat. This will continue to cook the food until it is removed or the oven cools down. If you do not plan on being present when the oven turns off, you should take this extra heating time into account.

Turn the function and temperature controls to the off position.

Touch any button to stop the timer beeping.

### Adjusting the clock

Touch the MODE symbol until the ⌚ clock icon begins flashing.

Touch the + and - symbols to change the time of day. 5 seconds after the last change, the clock icon will disappear, confirming the time has been adjusted.

# EVEP614

## COMPONENTS

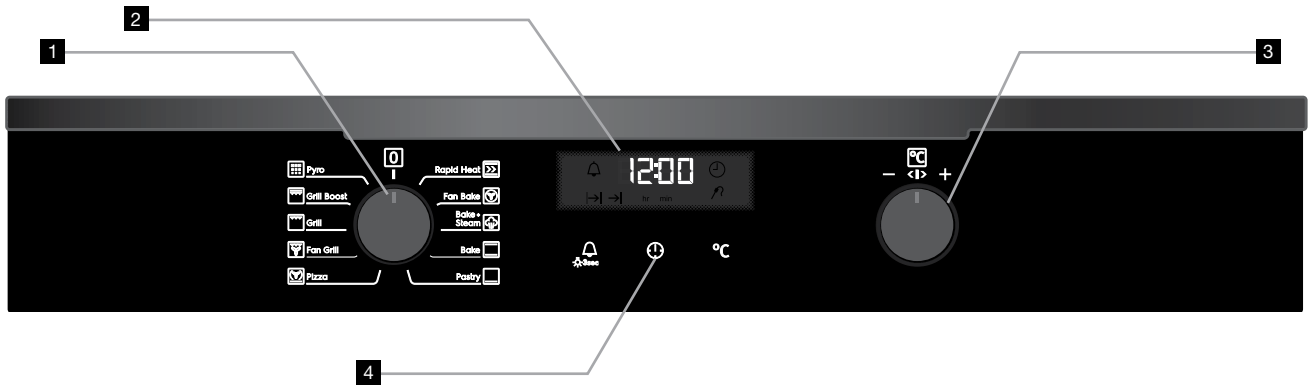

- 1 Function selector knob
- 2 Timer display
- 3 Temperature selector knob
- 4 Touch pad

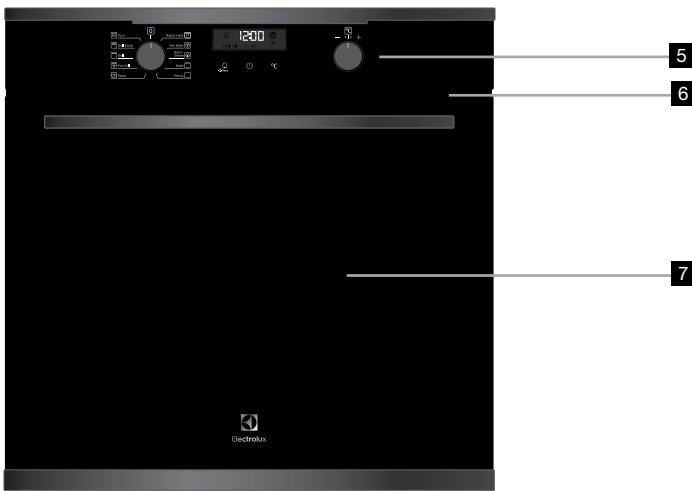

## EVEP614

- 5 Control panel
- 6 Warm air exhaust
- 7 Quad glazed door

## BEFORE USING THE APPLIANCE

### Setting the time

Before the appliance can be used, the time must be set.

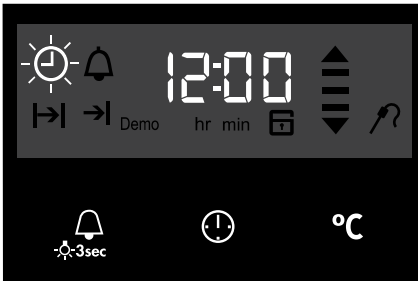

When power is supplied to the oven the  clock icon will be displayed. Along with the clock symbol the '12' will be flashing. This indicates that 'hour' portion of the time is ready to be changed.

Toggle the temp selector + or – , then touch  when you have the right hour.











The minutes will flash and can be set in the same manner. 5 seconds after the last change, the clock display will stop flashing, confirming that the time has been set.

*NOTE: The clock has a 24 hour display.*

# EVEP614 (CONTINUED)

## COOKING FUNCTIONS

### Symbol      Function description

<b>Rapid Heat</b> 	Heat comes from the element surrounding the fan as well as the smaller element above the food. This allows you to preheat your oven 30% quicker than on standard 'Bake'. 'Rapid Heat' is ideal for cooking frozen pre-cooked foods such as savoury pastries, pizzas, mini meals (TV dinners), meat pies and fruit pies. Simply place the food in the oven straight from the freezer and heat. Cook in the upper half of the oven for best results.
<b>Fan Bake</b> 	Heat comes from the element surrounding the fan. This fan circulates the hot air around the oven cavity so that you can put your food in different places in the oven and still cook them at the same time. You can use 'Fan Bake' function for multi-shelf cooking, reheating cooked foods, pastries and complete oven meals. It will cook at a lower temperature and be faster than baking. Please note that some variation in browning is normal.  <i>NOTE: The food probe function can be introduced into this cooking cycle.</i>
<b>Bake + Steam</b> 	Bake + Steam adds humidity at the beginning of the baking process. In bakery products, this allows the dough to rise and helps create a moist interior while obtaining a golden and crispy crust. Before preheating, when the oven is cold, add water to the cavity well. Refer to chapter 'Steam assisted cooking' for more details. For best results preheat the empty oven for 10 minutes prior to inserting food.  <i>NOTE: The food probe function can be introduced into this cooking cycle.</i>
<b>Bake</b> 	Heat comes from two elements, one above and one below the food. The bottom element is a clean heat element and is below the floor of the oven. Both elements are controlled by the thermostat and will turn on and off to maintain set temperature. You can use the 'Bake' function for single trays of biscuits, scones, muffins, cakes, slices, casseroles, baked puddings, roasts and delicate egg dishes.  <i>NOTE: The food probe function can be introduced into this cooking cycle.</i>
<b>Pastry</b> 	Heat comes from the clean heat element below the food. The element is controlled by the thermostat and will turn on and off to maintain the set temperature. The 'Pastry' function can be used to add extra browning to the bases of pizzas, pies, and pastries. Cook in the lower half of the oven when you are using only one shelf.  <i>NOTE: The food probe function can be introduced into this cooking cycle.</i>
<b>Pizza</b> 	'Pizza' is a combination of 'Pastry' and 'Fan Cook' and offers you the combined benefits of both functions. Heat comes from the element surrounding the fan as well as the clean heat element below the oven floor. The 'pizza' function is ideal for foods that require cooking and browning of the base. It is great for foods such as pizzas, quiches, meat pies and fruit pies. Simply put the food in the middle of the oven and select the desired temperature.  <i>NOTE: The food probe function can be introduced into this cooking cycle.</i>
<b>Fan Grill</b> 	'Fan Grill' offers you the benefits of both 'Bake' and traditional 'Grill' functions. The grill element turns on and off to maintain set temperature while the fan circulates the heated air.  <b>Fan grill with the oven door closed.</b>  You can use 'Fan Grill' for large cuts of meat, which gives you a result that is similar to 'rotisserie' cooked meat. Put your food on the grill shelf in position 2. When using 'Fan Grill' it is not necessary to turn food over during the cooking cycle. Set temperature to 180°C.  <i>NOTE: The food probe function can be introduced into this cooking cycle.</i>
<b>Grill</b> 	'Grill' function directs radiant heat from the powerful upper element onto the food. You can use the 'Grill' function for tender cuts of meat, steak, chops, sausages, fish, cheese toasties and other quick cooking foods.  <b>Grill with the oven door closed.</b>  Preheat your grill for 3 minutes to get the best results. This will help seal in the natural juices of steak, chops etc for better flavour. Place the grill shelf in position 4 with grill dish below to catch any spills.
<b>Grill Boost</b> 	'Grill Boost' directs radiant heat from 2 powerful upper elements onto the food. You can use the 'Maxi Grill' function for tender cuts of meat, steak, chops, sausages, fish, cheese toasties and other quick cooking foods.  <b>Grill with the oven door closed.</b>  'Grill Boost' allows you to take full advantage of the large grill dish area and will cook faster than normal 'Grill'. For best results it is recommended to preheat your grill for 3 minutes. This will help seal in the natural juices of steak, chops etc for a better flavour. Place the grill shelf in position 4 with grill dish below to catch any spills..
<b>Pyro</b> 	The 'pyrolytic cleaning' function cleans by burning off the spatters and accumulated dirt and grease from the oven liner, at high temperature. This process produces ash which can be wiped out of the oven cavity.
<b>Food Probe</b> 	The Food Probe measures the core temperature of the food. When the food reaches the desired set core temperature, the oven turns off. The Food Probe has a core temperature range of 50-99°C.  <i>Refer to 'Using Food Probe' chapter for more information</i>

## OPERATING SEQUENCE

### Select the oven function

Turn the oven function selector clockwise to select the desired oven function.

*NOTE: each oven function has a default temperature which can then be adjusted as outlined below.*

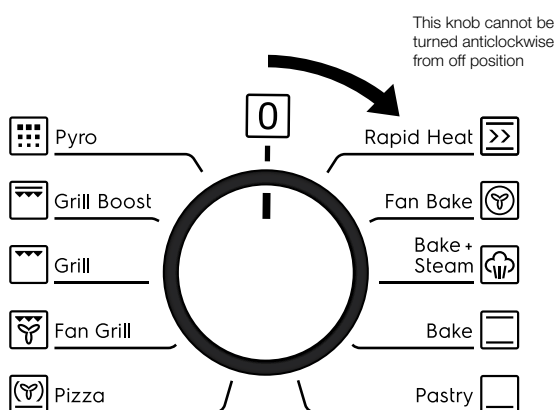

### Selecting the oven temperature

Toggle the temperature selector (left **-** or right **+**) as required to set the desired cooking temperature in °C.

*NOTE: the temperature can be adjusted at any time throughout the cooking time.*

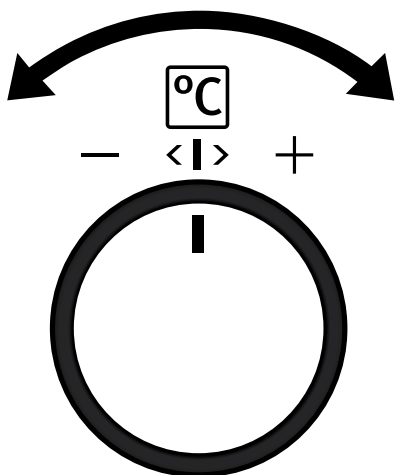

## USING THE APPLIANCE

### Cooking with the timer

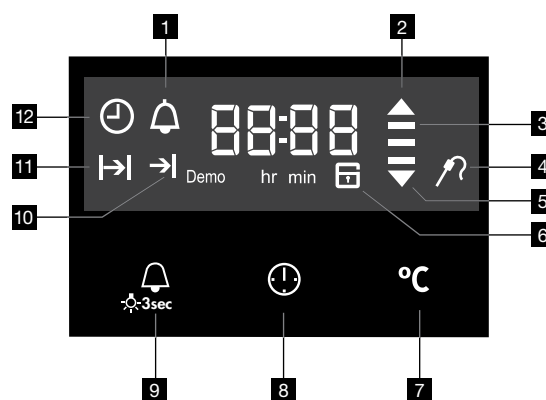

- 1 On when the timer is set
- 2 On when oven warming up
- 3 3 bars displayed when oven reaches set temperature
- 4 Food Probe icon
- 5 On when oven cooling down
- 6 Oven door locked
- 7 Touch to toggle through cooking time & oven set temp
- 8 Touch to toggle through the timer modes
- 9 Touch to start timer mode. Hold to turn oven light on/off
- 10 End time icon
- 11 Cook time icon
- 12 Time of day icon

## EVEP614 (CONTINUED)

### Adjusting the clock

To change the time, touch and hold the  button until the clock symbol begins to flash. The hour display will be ready to change.





Toggle the temp selector **+** or **-**, then touch  when you have the right hour.

The minutes will flash and can be set in the same manner.

5 seconds after the last change, the clock display will stop flashing, confirming that the time has been set.

*NOTE: The clock has a 24 hour display.*





### Setting the cook time

1. Use the knobs to select the desired oven function and cooking temperature.
2. Touch the  button as often as necessary, until the 'cook time'  symbol appears.
3. Set the desired cooking time commencing with minutes by using **+** or **-**, whilst the  symbol is flashing, then touch the  button again and set the hours by using **+** or **-**. After 5 seconds from the last time adjustment the  symbol will stop flashing. The appliance is now programmed and the display will countdown to zero.
4. When the set time has elapsed, a signal will sound and the appliance will turn off. To stop the signal, touch any button on the clock and then turn the oven function selector to OFF.

*NOTE: Cooking time cannot be set for the Rapid Heat function.*

*The feature can be cancelled at any time by returning the function selector to OFF.*







### Setting the end time

1. Use the knobs to select the desired oven function and cooking temperature.
2. Touch the  button as often as necessary, until the 'end time'  symbol appears.
3. Set the desired end time commencing with hours using **+** or **-** whilst the  symbol is flashing, then touch the  button again and set the minutes by using **+** or **-**. After 5 seconds from the last time adjustment the  symbol will stop flashing and the appliance is now programmed.
4. When the set time has elapsed, a signal will sound and the appliance will turn off. To stop the signal, touch any button on the clock and then turn the oven function selector to OFF.

*NOTE: Stop time cannot be set for the Rapid Heat function.*

### Setting the delayed start cooking time

The 'cook time' and 'end time' functions can be combined to switch the oven on and off at a specific time during the day.

1. Use the knobs to select the desired oven function and cooking temperature.
2. Touch the  button as often as necessary, until the 'cook time'  symbol appears.
3. Set the desired cooking time by using **+** or **-**, whilst the  symbol is flashing.
4. Touch the  button as often as necessary, until the 'end time'  symbol appears flashing.
5. Set the desired switch-off time using **+** or **-** whilst the 'end time'  symbol is flashing.
6. 5 seconds after the last change the 'cook time' and 'end time' arrows are lit to confirm that the oven has been programmed.
7. When the delayed start cooking time has elapsed, a signal will sound and the appliance will turn off. To stop the signal, press any button on the clock and then turn the oven function selector to OFF.

*NOTE: Delayed start cooking time cannot be set for the Rapid Heat function.*





*The feature can be cancelled at any time by returning the function selector to OFF.*



## Additional Functionality

Setting the countdown timer

Use this for timing any activity. For example boiling eggs.

1. Touch the  button, the display will flash.
2. Set the countdown time you want by using **+** and **-**. Commence with setting the number of seconds first. The minutes and hours can then be set by subsequently pressing the  button again and adjusting using **+** or **-**. 5 seconds after the last change the timer will stop flashing, confirming the timer has been set.
3. To cancel the timer touch the  button, the display will flash. Then touch and hold  and **°C** buttons until the timer is cleared.
4. To stop the beeper, touch any button.

*NOTE: The clock display cannot be selected when the timer is operating.*

## Elapsed Time

When an oven function is selected (other than pyrolytic clean) an elapsed timer commences on the display.



To reset this timer touch and hold both the  and **°C** buttons until the timer is reset.

## Displaying the oven temperature

During operation of the oven the current oven temperature during pre-heating of the oven can be displayed by touching the **°C** button. During normal operation the set temperature can be reviewed by touching the **°C** button.

*NOTE: this temperature will only be displayed for approximately 5 seconds.*

## Light operation

During operation of the oven the light can be switched off by touching and holding the  button until the light turns off. Also the light can be turned on from the standby state by touching and holding the  button until the light comes on.

## Activating the child-proof lock

When the child lock is engaged, the oven cannot be operated and the door cannot be opened.

1. Switch off the appliance using the function selector switch.
2. Touch and hold the  and **°C** buttons at the same time until the word 'SAFE' is displayed and a double beep is sounded. The word SAFE will be replaced by a padlock symbol on the display after 5 seconds.

## Releasing the child-proof lock

Touch and hold the  and **°C** buttons at the same time until a double beep is sounded. This will commence to unlock the door and after 5 seconds the oven is ready for use.

## Activating the function lock

The active function can be locked so it is not changed unintentionally.

1. The active function can be locked, to activate touch  and **°C** together until 'Loc' is displayed.
2. If the oven is switched-off while in 'Loc' it will switch into Child lock mode and the display will show 'SAFE'.
3. Oven can be released the same way as 'Releasing the child proof lock'

## Safety Cut-out feature

The oven automatically switches itself off if the temperature is not adjusted or the appliance is left operating after a period of time. The oven switches itself off after:

- 12.5 hours when the temperature is set less than 120°C.
- 8.5 hours when the temperature is set to 120°C or above, and below 200°C.
- 5.5 hours when the temperature is set to 200°C or above, and below 250°C.
- 3.0 hours when the temperature is set at 250°C.

## DEMO Mode

The oven can be set to operate in a demo mode (e.g. in a retail store). In this mode the display works and functions can be set but the oven does not actually heat. When in this mode the text 'DEMO' will be lit. The following instructions show how to enter and exit 'Demo' mode.

1. Ensure the oven is in the off state. Toggle and hold the selector to **+** until a beep sounds. The 'DEMO' text will begin to flash.
2. Toggle the temperature selector to set the first digit of display to 2. Touch clock to set.
3. Repeat step 2 until display shows 24:68. 3 beeps sound and DEMO will be shown.
4. To disable DEMO mode repeat steps 1 - 3.

# EVEP614 (CONTINUED)

## PYROLYTIC CLEANING THE OVEN

### Pyrolytic cleaning of the oven cavity

The oven has the Pyrolytic self-cleaning function. It cleans by burning off the spatters and accumulated dirt and grease from the oven liner, at high temperature. This process produces ash which can then be wiped out of the oven cavity.

Pyrolytic cleaning will not remove salt and mineral residue left in the cavity well when water evaporates. It is recommended that the residue is cleaned prior to conducting pyrolytic cleaning cycles. See section 'Cleaning the cavity well'.

### **WARNING**

**During the pyrolytic cleaning process the oven becomes extremely hot.**

- Please keep small children at a safe distance.
- Never clean non-stick baking trays and tins in the oven during the pyrolytic cycle. High temperatures damage the non-stick coating and poisonous gas is released.
- To prevent damage, do not use acids, sprays or similar cleaning agents.

### **CAUTION**

- **During pyrolytic cleaning the air outlet exhaust above the door must be kept clear of any obstruction (e.g. bulky tea towels).**
- **Do not use the oven to clean miscellaneous items (e.g. cookware).**

### Before carrying out the Pyrolytic function

1. All accessories must be removed from the oven, including shelves, trays and side racks.
2. Clean large deposits, spills or grease from the oven cavity.
3. Ensure the cavity well is free of limestone scaling (refer to cleaning the cavity well chapter)
4. Choose the Pyrolytic cleaning cycle from the following:

soiling	duration
light clean	1hr 30mins
normal clean	2hr 30mins

*NOTE: Duration includes heat-up time, excluding cool-down time.*

### Light clean

This is an energy saving cycle that can be used on a regular basis if the oven is lightly soiled. Possibly after every 2nd or 3rd roast.

### Normal clean

Use this as the regular cycle about once every 2-3 months.

### Pyrolytic Cleaning Operation

The pyrolytic cleaning function can be selected by turning the function selector switch clockwise to the pyrolytic position. Use **+** or **-** to toggle between a pyrolytic cleaning time of 1:30 hours or 2:30 hours. The pyrolytic function can be stopped at any time by turning the function selector counterclockwise to the OFF position.

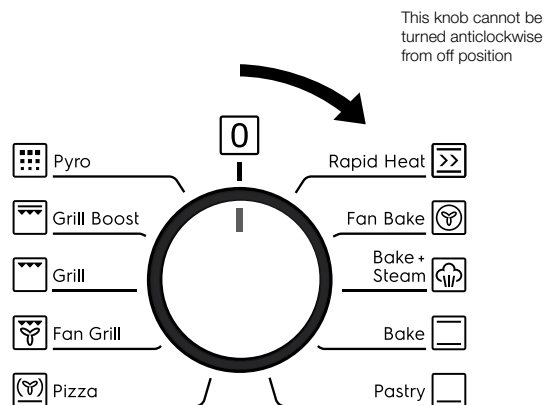

### **IMPORTANT**

**During Pyrolytic cleaning the door will automatically lock when the temperature in the oven approaches 300°C.  will appear on the display. During the pyrolytic cleaning cycle there may be some burn off odours. It is advised to keep the room well ventilated during this cycle.**

When the pyrolytic cleaning function is on, it is advisable not to use a cooktop if it is fitted above the oven. This could cause overheating and damage to both appliances.

The door will only unlock when the oven has cooled to a safe temperature. Turning the function off will not unlock the door. This will only happen when safe temperature is reached.

*NOTE: The cooling fan will operate at an increased speed for Pyrolytic cleaning and will continue to run until the oven has cooled down. This is normal. It is recommended to clean the oven regularly to keep it in its best condition.*

### After Pyrolytic cleaning

After cool-down, wipe the ash out of the oven with a soft damp cloth and warm water.

To restore the enamel shine to more difficult areas, use a damp cloth with vinegar and detergent.

### **CAUTION**

**Do not turn off the mains power supply to the oven during the pyrolytic cycle. This could damage the appliance.**

# EVE616

## COMPONENTS

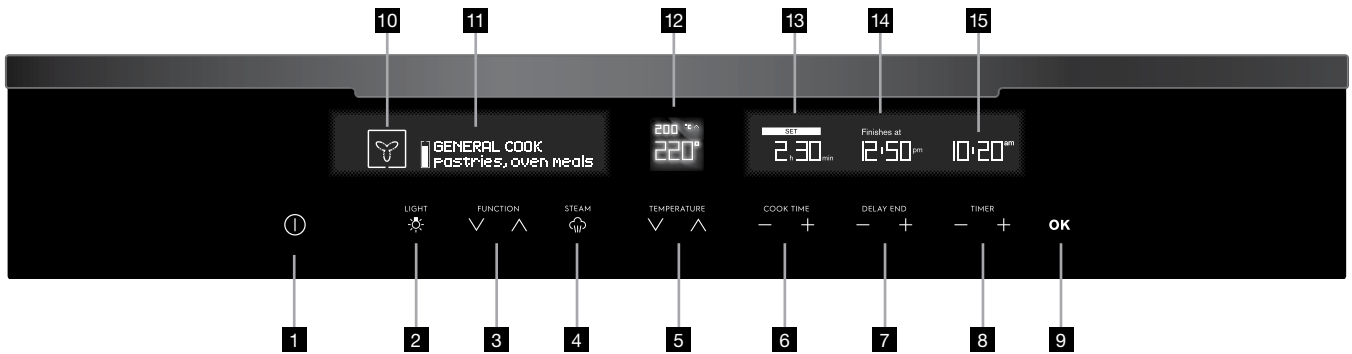

- |                                    |                                      |                                    |
|------------------------------------|--------------------------------------|------------------------------------|
| <b>1</b> ON/OFF                    | <b>6</b> Cook time control           | <b>11</b> Cooking function display |
| <b>2</b> Light on/off              | <b>7</b> Delay end control           | <b>12</b> Temperature display      |
| <b>3</b> Cooking function selector | <b>8</b> Set clock and timer control | <b>13</b> Cook time display        |
| <b>4</b> Steam on/off              | <b>9</b> Instant confirm             | <b>14</b> Delay end display        |
| <b>5</b> Temperature control       | <b>10</b> Cooking function icon      | <b>15</b> Clock/Timer display      |

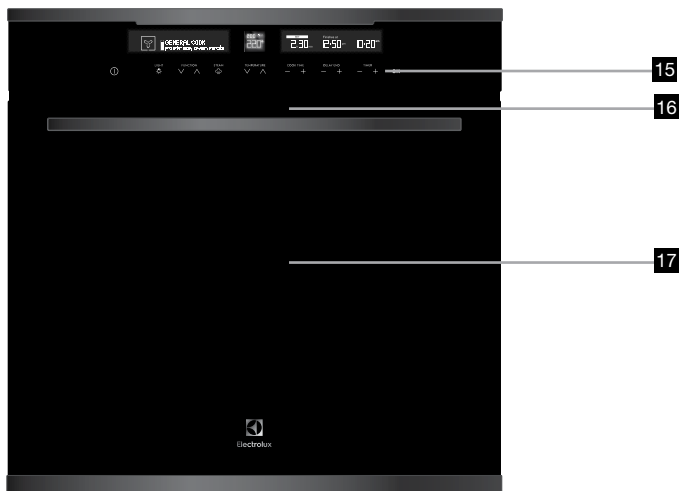

### EVE616

- 15** Control panel
- 16** Warm air exhaust
- 17** Triple glazed door

# EVE626, EVE636

## COMPONENTS

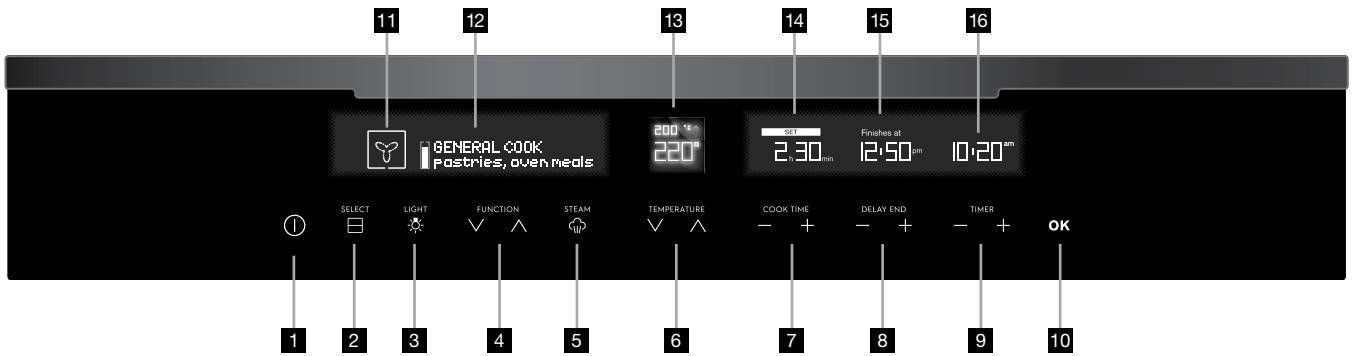

- |                                     |                                      |                                    |
|-------------------------------------|--------------------------------------|------------------------------------|
| <b>1</b> ON/OFF                     | <b>7</b> Cook time control           | <b>12</b> Cooking function display |
| <b>2</b> Upper/Lower level selector | <b>8</b> Delay end control           | <b>13</b> Temperature display      |
| <b>3</b> Light on/off               | <b>9</b> Set clock and timer control | <b>14</b> Cook time display        |
| <b>4</b> Cooking function selector  | <b>10</b> Instant confirm            | <b>15</b> Delay end display        |
| <b>5</b> Steam on/off               | <b>11</b> Cooking function icon      | <b>16</b> Clock/Timer display      |
| <b>6</b> Temperature control        |                                      |                                    |

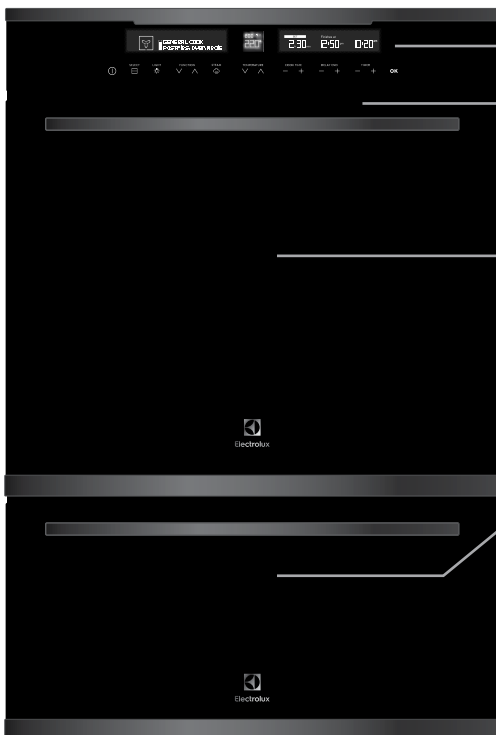

### EVE626

Double cavity model (duo)



### EVE636

Double cavity model (double wall oven)

- |   |
|---|
| <b>17</b> Control panel                                   |
| <b>18</b> Warm air exhaust                                |
| <b>19</b> Upper main oven with triple glazed door         |
| <b>20</b> Lower (half sized) oven with triple glazed door |
| <b>21</b> Lower (full sized) oven with triple glazed door |

# EVE616, EVE626, EVE636 (CONTINUED)

## BEFORE USING THE APPLIANCE

### Setting the time

The time of day must be set before the appliance can operate.

After the appliance has been electrically connected the display will cycle through the welcome screen, then 'Set Clock' will illuminate under the clock display and the Hour digits will flash.

1. Use the timer **+** and **-** to set the hour portion of the current time (including AM/PM).
2. Press OK when the hours are set correctly. The Minute digits will flash.
3. Use the timer **+** and **-** to set the minutes portion of the current time.
4. Press OK when the minutes are set correctly. You can turn the oven off or it will do so after 8 seconds. Once the time has been entered, the clock advances minute by minute.

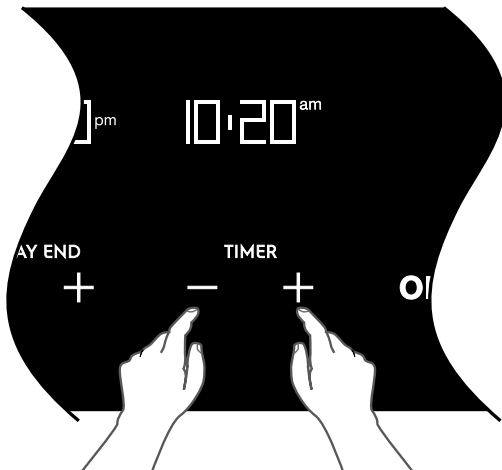















# EVE616, EVE626, EVE636 (CONTINUED)

## COOKING FUNCTIONS

Functions listed may not apply to all models.

### Symbol      Function description

<b>Fan Cooking</b> 	<p>Heat comes from the element surrounding the fan. This fan circulates the hot air around the oven cavity so that you can put your food in different places in the oven and still cook them at the same time. You can use the 'Fan Cooking' function for multi-shelf cooking, reheating cooked foods, pastries and complete oven meals. It will cook at a lower temperature and be faster than baking. Please note that some variation in browning is normal.</p> <p><i>🔪 NOTE: Where fitted, the food probe function can be introduced into this cooking cycle.</i></p> <p> <i>Steam can be added to 'Fan Cooking' at the beginning of the baking process. In bakery products, this allows the dough to rise and helps create a moist interior while obtaining a golden and crispy crust. Refer to 'Steam Assisted Cooking' chapter for more information.</i></p>
<b>Traditional bake</b> 	<p>Heat comes from two elements, one above and one below the food. The bottom element is a clean heat element and is below the floor of the oven. Both elements are controlled by the thermostat and will turn on and off to maintain set temperature. You can use the 'Traditional Bake' function for single shelf cooking, single trays of biscuits, scones, muffins, cakes, slices, casseroles, baked puddings, roasts and delicate egg dishes. This is a general function that can be used for most cooking.</p> <p><i>🔪 NOTE: Where fitted, the food probe function can be introduced into this cooking cycle.</i></p>
<b>Fan assist bake</b> 	<p>Heat comes from two elements, one above and one below the food. The fan circulates the hot air around the oven cavity so that you can put the food in different places in the oven and still cook them at the same time. You should only use a maximum of two shelves with 'Fan Assist Bake'.</p> <p>Do not use the bottom shelf. If the two shelves are used, food on the shelf in the higher position will cook first and should then be removed to allow the food on the lower shelf to finish cooking.</p> <p><i>🔪 NOTE: Where fitted, the food probe function can be introduced into this cooking cycle.</i></p>
<b>Roast</b> 	<p>The Roast function is designed for roasting meats, poultry and fish by utilising heat from all elements in combination with the fan to surround the food. This provides even cooking throughout and enhanced browning.</p> <p><i>🔪 NOTE: Where fitted, the food probe function can be introduced into this cooking cycle.</i></p>
<b>Pastry</b> 	<p>The 'Pastry' function is specially designed for food that require extra browning such as the bases of pastries and pies. Heat comes from the element below the food. If you choose the default setting, the oven will heat up to 230°C in order to brown the food. You should then lower the temperature as required. Cook in the lower half of the oven when you are using only one shelf.</p>
<b>Pizza</b> 	<p>'Pizza' is a combination of 'Pastry' and 'Fan Assist Bake' and offers you the combined benefits of both functions. Heat switches between the element surrounding the fan and the clean heat element below the oven floor. The 'Pizza' function is ideal for foods that require cooking and browning on the base. It is for foods such as pizzas, quiches, meat pies and fruit pies. Simply place the food in the middle of the oven and set the desired temperature.</p>

<p><b>Cook from frozen</b></p> 	<p>The 'Cook from Frozen' function is ideal for cooking frozen precooked foods such as savoury pastries, pizzas, mini meals (TV dinners), meat pies and fruit pies. Heat comes from the element surrounding the fan as well as a smaller element above the food. Simply place the food in the oven straight from the freezer and heat. Cook in the upper half of the oven for best results.</p>
<p><b>Grill Boost</b></p> 	<p>'Grill Boost' direct radiant heat from two powerful upper elements onto the food. You can use 'Grill Boost' function for tender cuts of meat, steak, chops, sausages, fish, cheese toasties and other quick cooking foods.</p> <p>Grill with the oven door closed.</p> <p>'Grill Boost' allows you to take full advantage of the large grill dish area and will cook faster than the normal 'Grill' function. For best results it is recommended to preheat your grill for three minutes. This will help seal in the natural juices of steak, chops etc for a better flavour.</p> <p>Place the grill shelf in position 4 with the grill dish below to collect any spills. Grill Boost has 2 temperature settings, 'LO' and 'HI'.</p>
<p><b>Grill</b></p> 	<p>The 'Grill' directs radiant heat from only one of the powerful upper elements onto the food. The 'Grill' function is used instead of 'Grill Boost' when only half the amount of heat is needed. Grill has 2 temperature settings, 'LO' and 'HI'.</p> <p>Grill with the oven door closed.</p>
<p><b>Fan grill</b></p> 	<p>'Fan Grill' offers you the benefits of both traditional bake and traditional grill functions. The grill element turns on and off to maintain set temperature while the fan circulates the heated oven air.</p> <p>Grill with the oven door closed.</p> <p>You can use 'Fan Grill' for large cuts of meat, which gives you a result similar to 'roisserie' cooked meat. Place food on grill shelf in position 2 with the grill dish below to catch any spills.</p> <p>When using 'Fan Grill' it is not necessary to turn the food over during the cooking cycle. Set temperature to 180°C.</p>
<p><b>Keep warm</b></p> 	<p>The 'Keep Warm' function is a low temperature oven function designed to keep your food at a perfect eating temperature without cooking it further. Heat comes from the smaller elements above the food and is circulated by the fan. Use 'Keep Warm' to keep your food warm while you prepare the rest of the meal or afterwards while you wait for the late arrival.</p> <p><i>NOTE: After cooking, the oven retains enough heat to continue to cook food even if the elements are turned off. The 'Keep warm' function recognises this by giving you a warning message. If this happens the function will not start.</i></p>
<p><b>Defrost</b></p> 	<p>The 'Defrost' function uses low temperature air that is circulated by the fan. You can defrost (thaw) your food before you cook it. You can also use 'Defrost' to raise your yeast dough and to dry fruit, vegetables and herbs. The 'Defrost' function does not have a suggested temperature but uses the ambient heat in the oven cavity.</p>
<p><b>Food Probe</b></p> 	<p>The Food Probe measures the core temperature of the food. When the food reaches the desired set core temperature, the oven turns off. The Food Probe has a core temperature range of 50 – 99°C.</p> <p><i>Refer to 'Using Food Probe' chapter for more information</i></p>

# EVE616, EVE626, EVE636 (CONTINUED)

## OPERATING SEQUENCE

### Turning the oven on

- Switch on the oven by touching the **⏻** ON/OFF symbol. The control panel will come on and inform you that you need to select a cooking function.
- If you do not select a function within 20 seconds the oven will turn off.

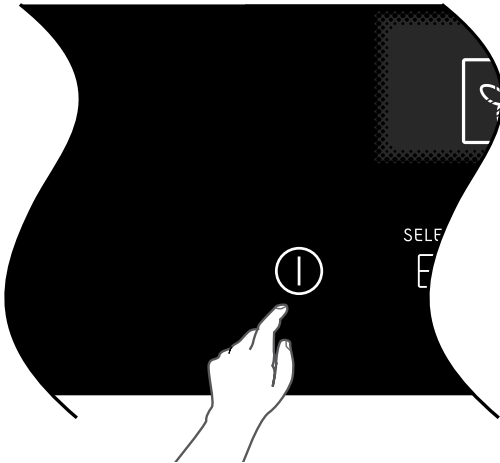

### Selecting the Upper or Lower oven

(EVE626, EVE636)

These models are equipped with two ovens. Use the oven selector symbol to toggle between the upper and lower ovens.

The oven cavity icon on the control panel will show which oven is currently active.

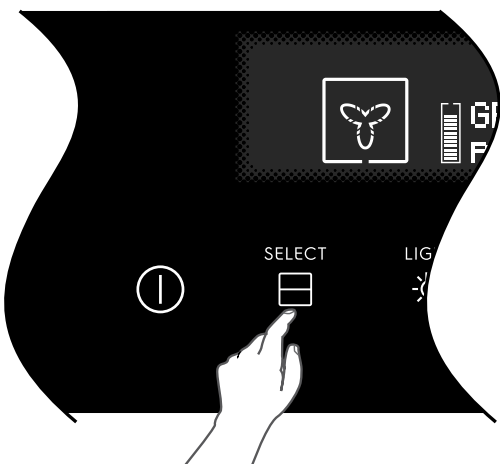

### Select a cooking function

The oven will have a selection of functions. Press the function **∧** or function **∨** symbols as many times as necessary until the desired function appears.

Cooking suggestions will appear under the function name and suggested cooking temperatures will appear above the temperature selector.

If no other symbol is touched within 8 seconds the oven will switch on and begin to heat up to the displayed temperature.

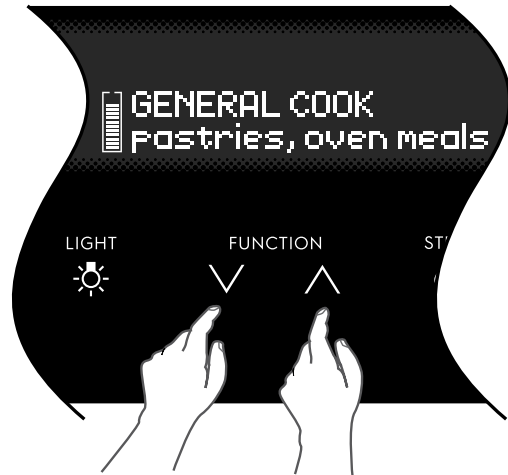

### Selecting a temperature

The temperature is electronically controlled.

The temperature can be selected within the range of 30°C to 250°C and can be adjusted at any time. To set the temperature, press the temperature **∧** and temperature **∨** symbols to reach the desired setting.

Touch OK, or if no further changes are made within 8 seconds the oven begins to heat up to the set temperature. The current oven temperature will appear above set temperature. This will change as the oven heats up and the heat up bar will change from grey to red.

When the temperature is reached, 'Set temperature reached' will appear and only the target temperature will be displayed.

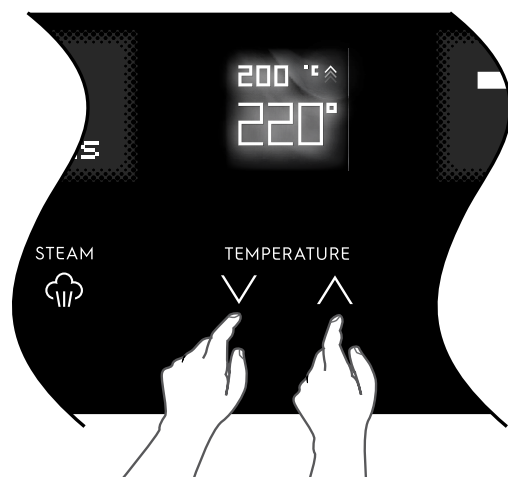



## USING THE APPLIANCE

### Turning the oven off

Single cavity models:

Touch the **ⓘ** ON/OFF symbol to switch off the oven. As the appliance cools down, 'cooling' will be displayed until the oven is below 100°C

Double cavity models:

1. Touch the upper/lower oven selector symbol to toggle to the desired oven.
2. Touch the **ⓘ** ON/OFF symbol to switch off the desired oven. The control panel will turn off to confirm that the oven is now switched off.
3. If the other oven is still active, after 1 second, the control panel will automatically revert to show the setting of that oven.
4. To turn off both ovens at once, touch and hold the **ⓘ** ON/OFF symbol for 5 seconds. All elements, cavity light and the control panel will then switch off at the same time.
5. If both ovens are off as the appliance cools down, 'cooling' will be displayed until both ovens are below approximately 100°C.

### Cooking with the timer

The oven is equipped with a programmable controller that can be used to turn the oven on and off automatically. The 'cook time' controls are used to automatically turn the oven off after a set amount of time. The 'Delay End' controls are used to set the time of day you want the cooking cycle to finish.

### Setting the cook time

1. Select the desired oven function and cooking temperature.
2. Touch the 'cook time' **+** symbol as often as necessary (or hold), until the desired cook time has been set.
3. Touch 'OK' or after 8 seconds from the last time adjustment the oven will start cooking and the 'cook time' display will countdown to zero.
4. The oven will turn off and beep when the 'cook time' display reaches zero.

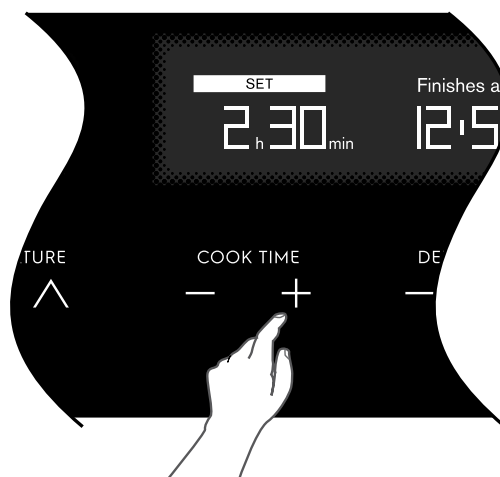

### **i** IMPORTANT

- **When you use the 'cook time' function, the 'Finishes at' display activates and tells you what time of day the oven will turn off (based on the set cook time).**
- **The cook time can be changed in the first 30 seconds by using the 'cook time' - or + symbols.**
- **When the cook time has elapsed, an audible signal will sound for 2 minutes, the oven will switch off and COOKING FINISHED will be displayed.**
- **To stop the audible signal, press any of the symbols on the control panel.**
- **If you wish to cook a bit longer, press the 'cook time' + symbol for each additional minute you require. The oven automatically reverts to the function and temperature previously programmed. This feature is available for 10 minutes after cooking has finished. After that, the oven automatically switches off.**

# EVE616, EVE626, EVE636 (CONTINUED)

## Setting the delay end time

The delay end function can be used to switch the oven on and off at a specific time during the day.

1. Check the clock displays the correct time of day.
2. Select the desired oven function and cooking temperature.
3. Set the required cook time.
4. Touch the 'delay end' symbol **+** to move the end time.
5. Touch 'OK' or after 8 seconds from the last time adjustment the SET icon will light and the oven is now programmed. The oven will start its cooking cycle to finish at the set 'end time'.
6. When the oven has finished cooking, cook time can be extended or the beeper turned off just as in 'cook time' mode.

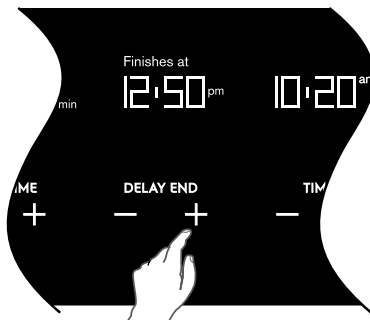

7. Touch the 'delay end' **+** symbol to move the end time forward.
8. Touch 'OK' or after 8 seconds from the last time adjustment the SET icon will light and the oven is now programmed.

The oven will commence its cooking cycle to finish at the set 'end time'.



### IMPORTANT

**30 seconds after a cooking function has started, it is no longer possible to delay the end time.**

**In order to delay a cooking function that has already started, the oven needs to be switched off then switched on again and re-programmed.**

Even though the heating element turns off the oven will still retain substantial heat. This will continue to cook the food until it is removed or the oven cools down. If you do not plan on being present when the oven turns off, you should take this extra heating time into account.

## Timers

The appliance has two timers which can be used one at a time. The count up timer can be used to measure a period of time. The count down timer beeps at the end of a preset time.

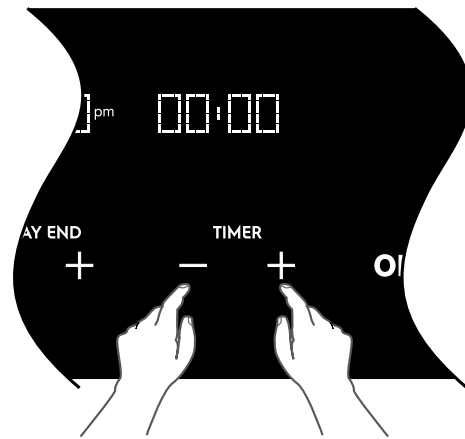

### Setting the count up timer

The timer can be used independently of the oven for measuring a count up period. There is no alert provided with this timer.

1. Touch either 'timer' **+** or **-**.
2. 00min will be displayed along with a bell and the up arrow will flash.
3. To begin the count up timer press OK.
4. To reset the count up timer, press 'timer' **-** once to show 00min. Press OK to restart.
5. To cancel the count up timer press 'timer' **-** twice.

### Setting the count down timer

The timer can be used independently of the oven for setting a count down period. When the period of time has elapsed, an audible signal sounds.

1. Touch either 'timer' **+** or **-**.
2. 00min will be displayed along with a bell and the up arrow will flash.
3. Touch the 'timer' **+** to set the countdown period.
4. The timer bell icon  will flash.
5. To begin the count down timer press OK or wait 8 seconds. When the timer starts, the bell will stop flashing and the timer will begin to count down.
6. When the set time has elapsed, an audible signal will sound for 2 minutes. The time indication '00min' and the timer bell will flash on the display.
7. To stop the signal, touch either of the 'timer' **+** or **-** symbols.
8. To cancel the count down timer touch 'timer' **-** until the normal time of day is displayed.

### Adjusting the clock

1. Switch on the oven by touching 'ON/OFF' symbol.
2. Select 'SETTINGS' from the function list and touch OK.
3. Select 'SET CLOCK' from the list and touch OK.
4. 'Set Clock' will illuminate under the clock display.
5. Use the timer **+** and **-** to set the hour portion of the current time (including AM/PM).
6. Touch 'OK' when the hours are set correctly.
7. Use the timer **+** and **-** to set the minutes portion of the current time.
8. Touch 'OK' when the minutes are set correctly. TIME SAVED will be displayed and then the function display will revert to the 'set clock' menu. Turn the oven off or it will do so after 8 seconds.

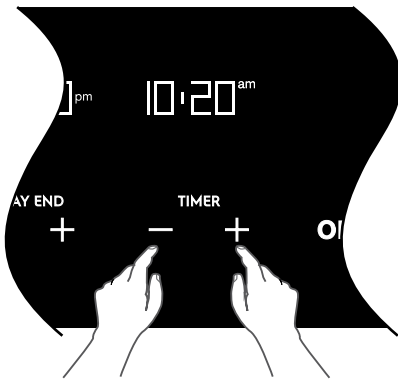

## ADDITIONAL FUNCTIONALITY

### Light on/off

Turn the oven light off and on in any cooking mode by simply touching the .

### DEMO Mode

This mode is intended to be used in retail shops to demonstrate the oven functionality without any power consumption except to the oven lights.

The following instructions show how to enter and exit 'DEMO' mode.

1. Ensure the oven is off by touching the ON/OFF symbol.
2. Touch and hold the ON/OFF symbol until the display turns ON then OFF. Immediately after, touch both the cooktime symbols simultaneously. Hold until a triple beep sounds.

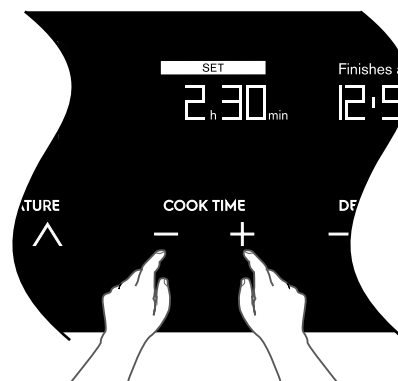

### Activating the child-proof lock

When the child lock is engaged, the oven cannot be switched on.

1. Switch on the oven by touching the 'ON/OFF' symbol.
2. Select 'SETTINGS' from the function list and touch 'OK'.
3. Select 'ACTIVATE LOCK' from the list and touch 'OK'.
4. The word 'LOCKED' will momentarily appear and a single beep will sound to confirm the operation. The child lock is now engaged.

### De-activating the child lock

1. Touch any symbol on the control panel (including the on/off symbol). 'Locked' will appear on the display.
2. Touch any symbol again. The display will instruct you to touch both 'cook time' symbols for 2 seconds.
3. Hold until a beep sounds. The child lock is now released and the oven is ready to use.

# EVE616, EVE626, EVE636 (CONTINUED)

## Other settings.

The 'Settings' function gives the opportunity to change oven functionality. Scroll through the list by using function up  $\blacktriangle$  or function down  $\blacktriangledown$ .

1. Switch on the oven by touching the 'ON/OFF' symbol.
2. Select 'SETTINGS' from the function list and touch OK.
3. Select 'SET CLOCK' to change the time of day.
4. Select 'TIME INDICATION' to have the time permanently displayed or not.
5. Select 'BUZZER VOLUME' to adjust the 'beep on touch' and alarm loudness.
6. Select 'KEY TONE' to turn the 'beep on touch' on or off.
7. Select 'SCREEN BRIGHTNESS' to adjust the brightness of the display.
8. Select 'SCREEN CONTRAST' to adjust the contrast of the display.
9. Select 'TEMPERATURE UNITS' to change between Celsius and Fahrenheit units.
10. Select "FAST HEAT UP" to enable or disable automatic fast heat up function.
11. Select "SERVICE INFO" to show the service information.
12. Select "FACTORY SETTINGS" to reset to original factory settings.
13. Select 'ACTIVATE LOCK' to turn child lock on.
14. Touch 'OK' to go into each selection to change its settings by using function up  $\blacktriangle$  or function down  $\blacktriangledown$ .

## Safety Cut-out feature

The oven automatically switches itself off if the temperature is not adjusted or the appliance is left operating after a period of time. The oven switches itself off after:

- 12.5 hours when the temperature is set between 30°C and 120°C.
- 8.5 hours when the temperature is set between 120°C and 200°C.
- 5.5 hours when the temperature is set between 200°C and 250°C.

# EVEP616, EVEP618

## COMPONENTS

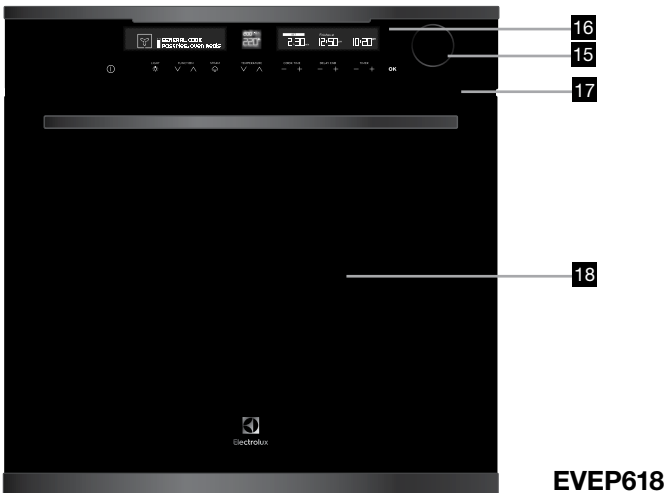
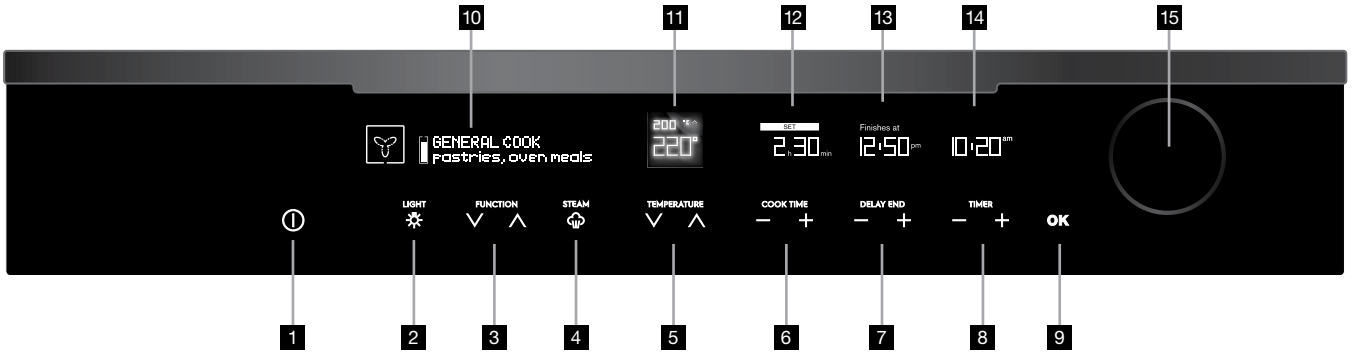

- |   |  |  |
|---|--|--|
| <ul style="list-style-type: none"> <li><b>1</b> ON/OFF</li> <li><b>2</b> Light on/off</li> <li><b>3</b> Cooking function selector</li> <li><b>4</b> Steam on/off</li> <li><b>5</b> Temperature control</li> <li><b>6</b> Cook time control</li> <li><b>7</b> Delay end control</li> </ul> | <ul style="list-style-type: none"> <li><b>8</b> Set clock and timer control</li> <li><b>9</b> Instant confirm</li> <li><b>10</b> Cooking function display</li> <li><b>11</b> Temperature display</li> <li><b>12</b> Cook time display</li> <li><b>13</b> Delay end display</li> <li><b>14</b> Clock/timer display</li> </ul> | <ul style="list-style-type: none"> <li><b>15</b> Water Drawer (EVEP618 only)</li> <li><b>16</b> Control panel</li> <li><b>17</b> Warm air exhaust</li> <li><b>18</b> Quad glazed door</li> </ul> |
|---|--|--|

# EVEP626

## COMPONENTS



**EVEP626** double cavity (duo)

- |                                    |                                      |                               |
|------------------------------------|--------------------------------------|-------------------------------|
| <b>1</b> ON/OFF                    | <b>7</b> Cook time control           | <b>13</b> Cook time display   |
| <b>2</b> Upper/Lower oven selector | <b>8</b> Delay end control           | <b>14</b> Delay end display   |
| <b>3</b> Light on/off              | <b>9</b> Set clock and timer control | <b>15</b> Clock/timer display |
| <b>4</b> Cooking function selector | <b>10</b> Instant confirm            | <b>16</b> Control panel       |
| <b>5</b> Steam function            | <b>11</b> Cooking function display   | <b>17</b> Warm air exhaust    |
| <b>6</b> Temperature control       | <b>12</b> Temperature display        | <b>18</b> Quad glazed door    |

# EVEP616, EVEP618, EVEP626

## BEFORE USING THE APPLIANCE

### Setting the time

The time of day must be set before the appliance can operate.

After the appliance has been electrically connected the display will cycle through the welcome screen, then 'Set Clock' will illuminate under the clock display and the Hour digits will flash.

1. Use the timer **+** and **-** to set the hour portion of the current time (including AM/PM).
2. Press OK when the hours are set correctly. The Minute digits will flash.
3. Use the timer **+** and **-** to set the minutes portion of the current time.
4. Press OK when the minutes are set correctly. You can turn off the oven or it will do so automatically after 8 seconds.



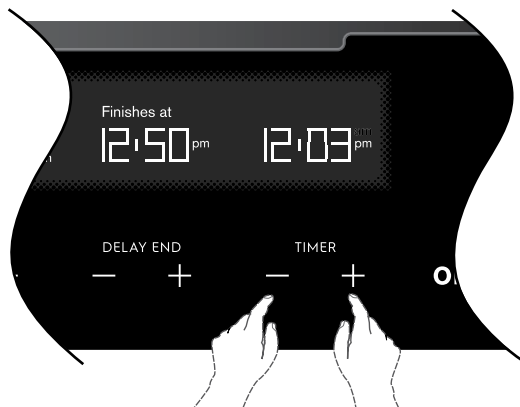









Once the time has been entered, the clock advances minute by minute.



# EVEP616, EVEP618, EVEP626 (CONTINUED)

## COOKING FUNCTIONS (Functions listed may not apply to all models.)









### Symbol      Function description

<p><b>Fan cooking</b></p> 	<p>Heat comes from the element surrounding the fan. This fan circulates the hot air around the oven cavity so that you can put your food in different places in the oven and still cook them at the same time. You can use the 'Fan Cooking' function for multi-shelf cooking, reheating cooked foods, pastries and complete oven meals. It will cook at a lower temperature and be faster than baking. Please note that some variation in browning is normal.</p> <p> <i>Steam can be added to 'Fan Cooking' at the beginning of the baking process. In bakery products, this allows the dough to rise and helps create a moist interior while obtaining a golden and crispy crust. Refer to 'Steam Assisted Cooking' chapter for more information.</i></p> <p><i>NOTE: The food probe function can be introduced into this cooking cycle.</i></p>
<p><b>Steam cooking</b></p> 	<p>EVEP618 only</p> <p>Steam comes from the outlet pipe and heat comes from the element surrounding the fan. This fan circulates the hot air and steam around the oven cavity so that you can put your food in different places in the oven. This combination of steam and hot air together cooks food with a tender interior and crisp exterior. Browning of meat or fish will be perfect with the best cooking result at the core. The shape will be always be preserved and evenly firm. Vegetables will benefit with a high retention of nutrients.</p> <p>Steam will only start if the water tank has been filled and the oven temperature is over 130°C.</p> <p><i>NOTE: The food probe function can be introduced into this cooking cycle.</i></p>
<p><b>Traditional bake</b></p> 	<p>Heat comes from two elements, one above and one below the food. The bottom element is a clean heat element and is below the floor of the oven. Both elements are controlled by the thermostat and will turn on and off to maintain set temperature. You can use the 'Traditional Bake' function for single shelf cooking, single trays of biscuits, scones, muffins, cakes, slices, casseroles, baked puddings, roasts and delicate egg dishes. This is a general function that can be used for most cooking.</p> <p><i>NOTE: The food probe function can be introduced into this cooking cycle.</i></p>
<p><b>Fan assist bake</b></p> 	<p>Heat comes from two elements, one above and one below the food. The fan circulates the hot air around the oven cavity so that you can put the food in different places in the oven and still cook them at the same time. You should only use a maximum of two shelves with 'Fan Assist Bake'.</p> <p>Do not use the bottom shelf. If the two shelves are used, food on the shelf in the higher position will cook first and should then be removed to allow the food on the lower shelf to finish cooking.</p> <p> <i>NOTE: EVEP618 gives you the option to introduce steam into this cooking cycle.</i></p> <p><i>NOTE: The food probe function can be introduced into this cooking cycle.</i></p>
<p><b>Roast</b></p> 	<p>The Roast function is designed for roasting meats, poultry and fish by utilising heat from all elements in combination with the fan to surround the food. This provides even cooking throughout and enhanced browning.</p> <p> <i>NOTE: EVEP618 gives you the option to introduce steam into this cooking cycle.</i></p> <p><i>NOTE: The food probe function can be introduced into this cooking cycle.</i></p>
<p><b>Pastry</b></p> 	<p>The 'Pastry' function is specially designed for food that require extra browning such as the bases of pastries and pies. Heat comes from the element below the food. If you choose the default setting, the oven will heat up to 230°C in order to brown the food.</p> <p>You should then lower the temperature as required. Cook in the lower half of the oven when you are using only one shelf.</p>
<p><b>Pizza</b></p> 	<p>'Pizza' is a combination of 'Pastry' and 'Fan Assist Bake' and offers you the combined benefits of both functions. Heat switches between the element surrounding the fan and the clean heat element below the oven floor. The 'Pizza' function is ideal for foods that require cooking and browning on the base. It is for foods such as pizzas, quiches, meat pies and fruit pies. Simply place the food in the middle of the oven and set the desired temperature.</p> <p> <i>NOTE: EVEP618 gives you the option to introduce steam into this cooking cycle.</i></p>
<p><b>Bread baking</b></p> 	<p>EVEP618 only</p> <p>Steam comes from the outlet pipe and heat comes from the element surrounding the fan. This fan circulates the hot air and steam around the oven cavity so that you can put your food in different places in the oven. The bread baking function creates a great loaf in terms of shape, colour of the top, uniform browning and texture. This function is suggested for baking bread or in general bakery products.</p> <p>Steam will only start if the water tank has been filled and the oven temperature is over 130°C.</p>



## COOKING FUNCTIONS (Functions listed may not apply to all models.)

### Symbol      Function description

<p><b>Cook from frozen</b></p> 	<p>The 'Cook from Frozen' function is ideal for cooking frozen precooked foods such as savoury pastries, pizzas, mini meals (TV dinners), meat pies and fruit pies. Heat comes from the element surrounding the fan as well as a smaller element above the food. Simply place the food in the oven straight from the freezer and heat. Cook in the upper half of the oven for best results.</p>
<p><b>Grill boost</b></p> 	<p>'Grill Boost' direct radiant heat from two powerful upper elements onto the food. You can use 'Grill Boost' function for tender cuts of meat, steak, chops, sausages, fish, cheese toasties and other quick cooking foods.</p> <p><b>Grill with the oven door closed.</b></p> <p>'Grill Boost' allows you to take full advantage of the large grill dish area and will cook faster than the 'Grill' function. For best results it is recommended to preheat your grill for three minutes. This will help seal in the natural juices of steak, chops etc for a better flavour.</p> <p>Place the grill shelf in position 4 with the grill dish below to catch any spills. 'Grill Boost' has 2 temperature settings, 'LO' and 'HI'.</p>
<p><b>Grill</b></p> 	<p>The 'Grill' directs radiant heat from only one of the powerful upper elements onto the food. The 'Grill' function is used instead of 'Grill Boost' when only half the amount of heat is needed. 'Grill' has 2 temperature settings, 'LO' and 'HI'.</p> <p><b>Grill with the oven door closed.</b></p>
<p><b>Fan grill</b></p> 	<p>'Fan Grill' offers you the benefits of both traditional bake and traditional grill functions. The grill element turns on and off to maintain set temperature while the fan circulates the heated oven air.</p> <p><b>Grill with the oven door closed.</b></p> <p>You can use 'Fan Grill' for large cuts of meat, which gives you a result similar to 'roisserie' cooked meat. Place your food on the grill shelf in position 2 with the grill dish below to catch any spills. When using 'Fan Grill' it is not necessary to turn the food over during the cooking cycle. Set temperature to 180°C.</p>
<p><b>Steam reheat</b></p> 	<p>EVEP618 only</p> <p>Steam comes from the outlet pipe and heat switches between the element surrounding the fan and the clean heat element below the oven floor. It's not possible to set the temperature for this function. It is fixed at 130°C.</p> <p>To reheat already cooked food (rice, pasta, pizza, vegetables) directly on a plate without drying it out or leaving it soggy.</p> <p>Steam will only start if the water tank has been filled and the oven temperature is over 130°C.</p>
<p><b>Keep warm</b></p> 	<p>The 'Keep Warm' function is a low temperature oven function designed to keep your food at a perfect eating temperature without cooking it further. Heat comes from the smaller elements above the food and is circulated by the fan. Use 'Keep Warm' to keep your food warm while you prepare the rest of the meal or afterwards while you wait for the late arrival.</p> <p><i>NOTE: After cooking, the oven retains enough heat to continue to cook food even if the elements are turned off. The 'Keep warm' function recognises this by giving you a warning message. If this happens the function will not start.</i></p>
<p><b>Defrost</b></p> 	<p>The 'Defrost' function uses low temperature air that is circulated by the fan. You can defrost (thaw) your food before you cook it. You can also use 'defrost' to raise your yeast dough and to dry fruit, vegetables and herbs. The 'Defrost' function does not have a suggested temperature but uses the ambient heat in the oven cavity.</p>
<p><b>Pyro clean</b></p> 	<p>The 'pyrolytic cleaning' function cleans by burning off the spatters and accumulated dirt and grease from the oven liner, at high temperature. This process produces ash which can be wiped out of the oven cavity.</p>
<p><b>Food Probe</b></p> 	<p>The Food Probe measures the core temperature of the food. When the food reaches the desired set core temperature, the oven turns off. The Food Probe has a core temperature range of 50 – 99°C.</p>

# EV6P616, EV6P618, EV6P626 (CONTINUED)

## OPERATING SEQUENCE

### Turning the oven on

- Switch on the oven by touching the **ⓘ** ON/OFF symbol. The LCD control panel will come on and inform you that you need to select a cooking function.
- If you do not select a function within 20 seconds the oven will turn off.

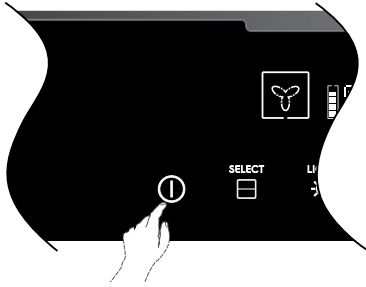

### Selecting the upper and lower oven

(EV6P626)

This model is equipped with two ovens. Use the oven selector symbol to toggle between the upper and lower ovens.

The oven cavity icon on the control panel will show which oven is currently active.

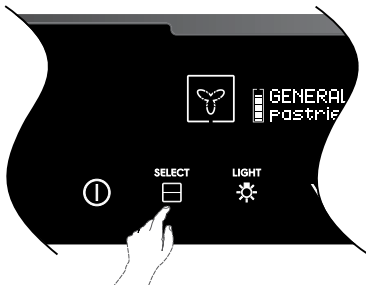

### Select a cooking function

The oven will have a selection of functions. Press the function **▲** or function **▼** symbols as many times as necessary until the desired function appears.

Cooking suggestions will appear under the function name and suggested cooking temperatures will appear above the temperature selector.

If no other symbol is touched within 8 seconds the oven will switch on and begin to heat up to the displayed temperature.

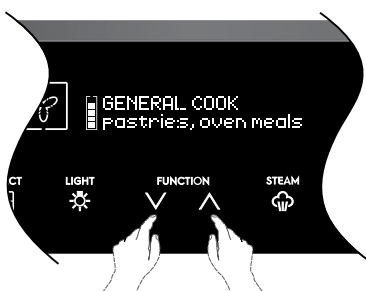

### Selecting a temperature

The temperature is electronically controlled.

The temperature can be selected within the range of 30°C to 250°C and can be adjusted at any time. To set the temperature, press the temperature **▲** and temperature **▼** symbols to reach the desired setting.

Touch **OK**, or if no further changes are made within 8 seconds the oven begins to heat up to the set temperature. The current oven temperature will appear above set temperature. This will change as the oven heats up and the heat up bar will change from grey to red.

When the temperature is reached, 'Set temperature reached' will appear and only the target temperature will be displayed.

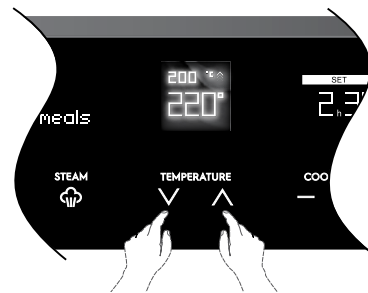

### Turning the oven off

Single cavity models:

Touch the **ⓘ** ON/OFF symbol to switch off the oven. As the appliance cools down 'cooling' will be displayed until the oven reaches approximately 100°C.

Double cavity models:

1. Touch the upper/lower oven selector symbol to toggle to the desired oven.
2. Touch the **ⓘ** ON/OFF symbol to switch off the desired oven. The control panel will turn off to confirm that the oven is now switched off.
3. If the other oven is still active, after 1 second, the control panel will automatically revert to show the setting of that oven.
4. To turn off both ovens at once, touch and hold the **ⓘ** ON/OFF symbol for 5 seconds. All elements, cavity light and the control panel will then switch off at the same time.
5. If both ovens are off as the appliance cools down, 'cooling' will be displayed until both ovens are below approximately 100°C.

## USING THE APPLIANCE

### Cooking with the timer

The oven is equipped with a programmable controller that can be used to turn the oven on and off automatically. The 'cook time' controls are used to automatically turn the oven off after a set amount of time. The 'Delay End' controls are used to set the time of day you want the cooking cycle to finish.

### Setting the cook time

1. Select the desired oven function and cooking temperature.
2. Touch the 'cook time' **+** symbol as often as necessary (or hold), until the desired cook time has been set.
3. Touch 'OK' or after 8 seconds from the last time adjustment the oven will start cooking and the 'cook time' display will countdown to zero.
4. The oven will turn off and beep when the 'cook time' display reaches zero.

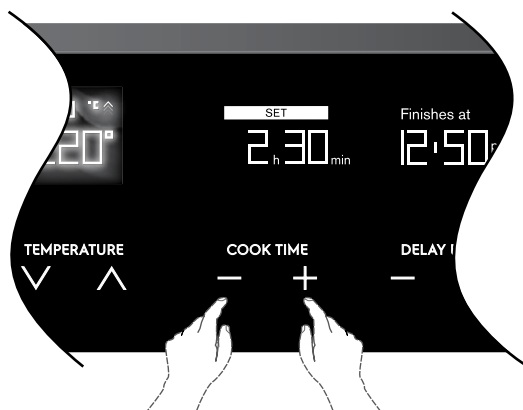

### **i** IMPORTANT

- When you use the 'cook time' function, the 'Finishes at' display activates and tells you what time of day the oven will turn off (based on the set cook time).
- During cooking, you can adjust the cook time with the 'cook time' **-** or **+** symbols for better cooking performance.
- When the cook time has elapsed, an audible signal will sound for 2 minutes, the oven will switch off and **COOKING FINISHED** will be displayed.
- To stop the audible signal, press any of the symbols on the control panel.

- If you wish to cook a bit longer, press the 'cook time' **+** symbol for each additional minute you require. The oven automatically reverts to the function and temperature previously programmed. This feature is available for 10 minutes after cooking has finished. After that, the oven automatically switches off.
- When using the Food Probe (where applicable), the duration and end time functions do not operate.

### Setting the delay end time

The delay end function can be used to switch the oven on and off at a specific time during the day.

1. Check the clock displays the correct time of day.
2. Select the desired oven function and cooking temperature.
3. Set the required cook time.
4. Touch the 'delay end' symbol **+** to move the end time.
5. Touch 'OK' or after 8 seconds from the last time adjustment the SET icon will light and the oven is now programmed. The oven will start its cooking cycle to finish at the set 'end time'.
6. When the oven has finished cooking, cook time can be extended or the beeper turned off just as in 'cook time' mode.

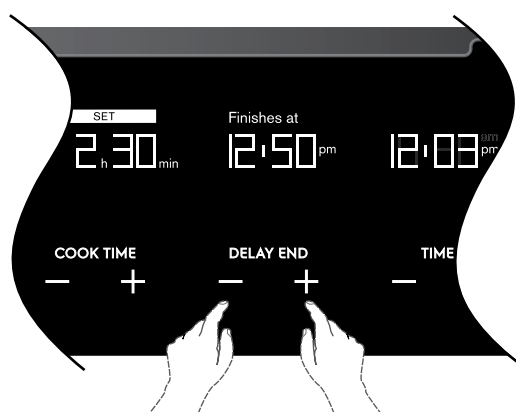

7. Touch the 'delay end' **+** symbol to move the end time forward.
8. Touch 'OK' or after 8 seconds from the last time adjustment the SET icon will light and the oven is now programmed.

The oven will commence its cooking cycle to finish at the set 'end time'.

# EV6P616, EV6P618, EV6P626 (CONTINUED)

## **i** IMPORTANT

- **30 seconds after a cooking function has started, it is no longer possible to delay the end time.**
- **In order to delay a cooking function that has already started, the oven needs to be switched off then switched on again and re-programmed.**
- **Even though the heating element turns off the oven will still retain substantial heat. This will continue to cook the food until it is removed or the oven cools down. If you do not plan on being present when the oven turns off, you should take this extra heating time into account.**

## Timers

The appliance has two timers which can be used one at a time. The count up timer can be used to measure a period of time. The count down timer beeps at the end of a preset time.

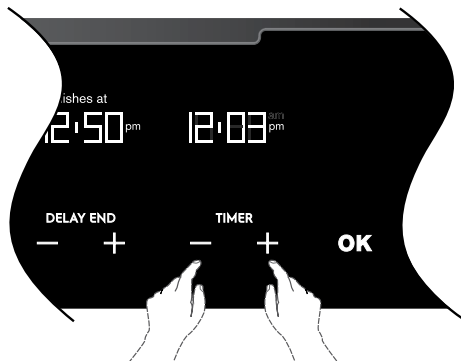

## Setting the count up timer

The timer can be used independently of the oven for measuring a count up period. There is no alert provided with this timer.

1. Touch either 'timer' **+** or **-**.
2. 00min will be displayed along with a bell and the up arrow will flash.
3. To begin the count up timer press OK.
4. To reset the count up timer, press 'timer' **-** once to show 00min. Press OK to restart.
5. To cancel the count up timer press 'timer' **-** twice.

## Setting the count down timer

The timer can be used independently of the oven for setting a count down period. When the period of time has elapsed, an audible signal sounds.

1. Touch either 'timer' **+** or **-**.
2. 00min will be displayed along with a bell and the up arrow will flash.
3. Touch the 'timer' **+** to set the countdown period.
4. The timer bell icon  will flash.
5. To begin the count down timer press OK or wait 8 seconds. When the timer starts, the bell will stop flashing and the timer will begin to count down.
6. When the set time has elapsed, an audible signal will sound for 2 minutes. The time indication '00min' and the timer bell will flash on the display.
7. To stop the signal, touch either of the 'timer' **+** or **-** symbols.
8. To cancel the count down timer touch 'timer' **-** until the normal time of day is displayed.

## Adjusting the clock

1. Switch on the oven by touching 'ON/OFF' symbol.
2. Select 'SETTINGS' from the function list and touch OK.
3. Select 'SET CLOCK' from the list and touch OK.
4. 'Set Clock' will illuminate under the clock display.
5. Use the timer **+** and **-** to set the hour portion of the current time (including AM/PM).
6. Touch 'OK' when the hours are set correctly.
7. Use the timer **+** and **-** to set the minutes portion of the current time.
8. Touch 'OK' when the minutes are set correctly. TIME SAVED will be displayed and then the function display will revert to the 'set clock' menu. Turn the oven off or it will do so after 8 seconds.

## ADDITIONAL FUNCTIONALITY

### Light on/off

Turn the oven light off and on in any cooking mode by simply touching the light  symbol.

### DEMO Mode

This mode is intended to be used in retail shops to demonstrate the oven functionality without any power consumption except to the oven lights.

The following instructions show how to enter and exit 'DEMO' mode.

1. Ensure the oven is off by touching the 'ON/OFF' symbol.
2. Touch and hold the 'ON/OFF' symbol until the display turns ON then OFF. Immediately after, touch both the cooktime symbols simultaneously. Hold until a triple beep sounds.

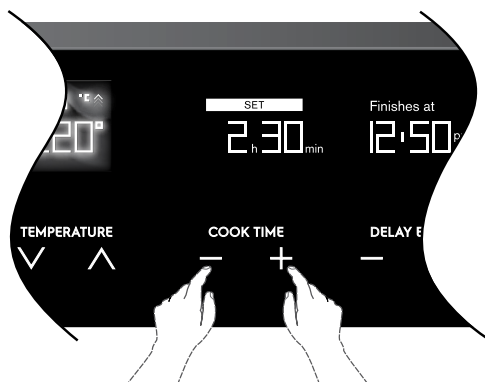

### Activating the child-proof lock



When the child lock is engaged, the oven cannot be switched on.



1. Switch on the oven by touching the 'ON/OFF' symbol.
2. Select 'SETTINGS' from the function list and touch 'OK'.
3. Select 'ACTIVATE LOCK' from the list and touch 'OK'.
3. The word 'LOCKED' will momentarily appear and a single beep will sound to confirm the operation. The child lock is now engaged.

### De-activating the child lock

1. Touch any symbol on the control panel (including the on/off symbol). 'Locked' will appear on the display.
2. Touch any symbol again. The display will instruct you to touch both 'cook time' symbols for 2 seconds.
3. Hold until a beep sounds. The child lock is now released and the oven is ready to use.

### Other settings.

The 'Settings' function gives the opportunity to change oven functionality. Scroll through the list by using function up  or function down .

1. Switch on the oven by touching the 'ON/OFF' symbol.
2. Select 'SETTINGS' from the function list and touch OK.
3. Select 'SET CLOCK' to change the time of day.
4. Select 'TIME INDICATION' to have the time permanently displayed or not.
5. Select 'BUZZER VOLUME' to adjust the 'beep on touch' and alarm loudness.
6. Select 'KEY TONE' to turn the 'beep on touch' on or off.
7. Select 'SCREEN BRIGHTNESS' to adjust the brightness of the display.
8. Select 'SCREEN CONTRAST' to adjust the contrast of the display.
9. Select 'TEMPERATURE UNITS' to change between Celsius and Fahrenheit units.
10. Select "FAST HEAT UP" to enable or disable automatic fast heat up function.
11. Select "CLEANING REMINDER" to enable or disable the cleaning reminder function.
12. Select "SERVICE INFO" to show the service information.
13. Select "FACTORY SETTINGS" to reset to original factory settings.
14. Select 'ACTIVATE LOCK' to turn child lock on.
15. Touch 'OK' to go into each selection to change its settings by using function up  and function down .

### Safety Cut-out feature

The oven automatically switches itself off if the temperature is not adjusted or the appliance is left operating after a period of time. The oven switches itself off after:

- 12.5 hours when the temperature is set between 30°C and 120°C.
- 8.5 hours when the temperature is set between 120°C and 200°C.
- 5.5 hours when the temperature is set between 200°C and 250°C.

# EVEP616, EVEP618, EVEP626 (CONTINUED)

## CLEANING THE OVEN



### CAUTION

**A steam cleaner is not to be used to clean the product.**

### Cleaning steam parts

#### EVEP618

After some time, the water tank can accumulate mineral deposits. To prevent this from occurring, empty the water tank after each steam cooking session and clean the water tank every two to three months using the following process.



### IMPORTANT

**During the cleaning procedure, some water can drip from the steam outlet onto the cavity of the oven. Put a dripping pan on the shelf level directly below the steam inlet to prevent water from falling onto the bottom of the oven cavity.**

### Cleaning procedure

1. With oven turned off, fill the water tank with a cleaning solution of 850mL of water and 50mL of citric acid. Let sit for approximately 60 minutes.
2. Turn on the oven and set to 'steam cooking'. Set the temperature to 230°C. After 25 minutes, turn off the oven and let it cool for 15 minutes.
3. Turn on the oven again and set to 'steam cooking'. Set the temperature to 180°C. After 10 minutes, turn off the oven and let it cool for 15 minutes. Insert the supplied drain pipe and empty the tank of remaining water. When tank is empty, remove the drain pipe.
4. To flush cleaning solution from water tank, refill the water tank with 850mL fresh water and empty via the drain pipe.
5. Remove the drain pipe again and clean by hand in warm water with soap.
6. To prevent build up of calcium deposits it is recommended to use this procedure every 2-3 months.

### Pyrolytic cleaning of the oven cavity

The oven has the Pyrolytic self-cleaning function, it cleans by burning off the spatters and accumulated dirt and grease from the oven liner, at high temperature. This process produces ash which can then be wiped out of the oven cavity.



### WARNING

**During the pyrolytic cleaning process the oven becomes extremely hot.**

- Please keep small children at a safe distance.
- Never clean non-stick baking trays and tins in the oven during the pyrolytic cycle. High temperatures damage the non-stick coating and poisonous gas is released.
- Do not put water into the water tank during the cleaning procedure.
- To prevent damage, do not use acids, sprays or similar cleaning agents.



### CAUTION

**During pyrolytic cleaning the air outlet exhaust above the door must be kept clear of any obstruction (e.g. bulky tea towels).**

**Do not use your oven to clean miscellaneous items (e.g. cookware).**

**If you have a steam oven, do not cause the water tank to overflow during the cleaning cycle. This could damage the enamel**

### Before carrying out the Pyrolytic function

- All accessories must be removed from the oven, including shelves, trays and side racks.
- Clean large deposits, spills or grease from the oven cavity.
- If you have a steam oven ensure the water tank is empty.
- Pyrolytic cleaning can release fumes that are not harmful to humans, including infants or persons with medical conditions, however you are strongly advised to provide good ventilation during and after each pyrolytic cleaning process.
- Unlike humans, some birds and reptiles can be extremely sensitive to the potential fumes emitted during the pyrolytic cleaning process. It is strongly advised to remove any pets (especially birds) from the vicinity of the appliance during and after each pyrolytic cleaning process.
- Small pets can also be highly sensitive to the localized temperature changes in the vicinity of all pyrolytic ovens when the pyrolytic self cleaning program is in operation.
- Pyrolytic cleaning will not remove salt and mineral residue left in the cavity well when water evaporates. It is recommended that the residue is cleaned prior to conducting pyrolytic cleaning cycles. See section 'Cleaning the cavity well'.

- Choose your Pyrolytic cleaning cycle from the following:

soiling	duration
light clean	1hr 30mins
medium clean	2hrs
heavy clean	2hr 30mins

*NOTE: Duration includes heat-up time, excluding cool-down time.*

### Light clean

This is an energy saving cycle that can be used on a regular basis if the oven is lightly soiled. Possibly after every 2nd or 3rd roast.

### Medium clean

Use this as the regular cycle about once every 2-3 months.

### Heavy clean

When the oven is very dirty it may need a longer cycle to clean it thoroughly. This cycle will clean the dirtiest of ovens.

### Turning the oven on

Switch on the oven by touching the **ⓘ** ON/OFF symbol. The control panel will come on and inform you that you need to select a cooking function.

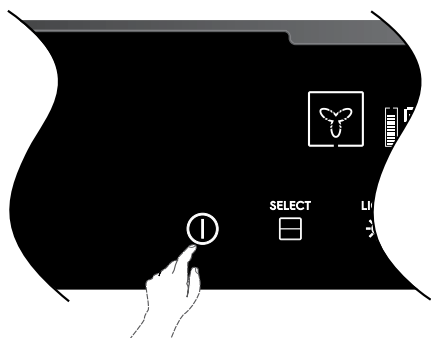

### Selecting the upper or lower oven

(EVEP626)

This model is equipped with two ovens. Use the oven selector symbol to toggle between the upper and lower ovens.

The oven cavity icon on the control panel will show which oven is currently active.

Only one cavity can be cleaned at a time.

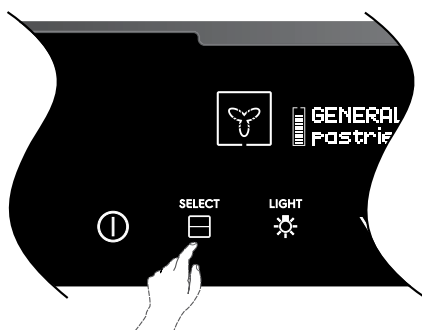

### Select the pyrolytic clean function.

Use cooking function selector to select the 'pyro clean' function.

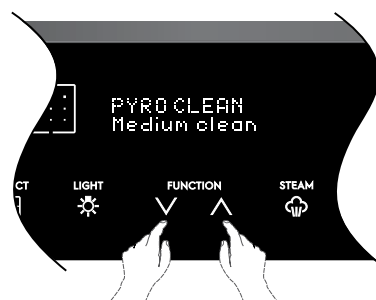

### Selecting the required cleaning cycle

Use the 'cook time' control to select Light, Medium or Heavy depending on the soiling of the oven.

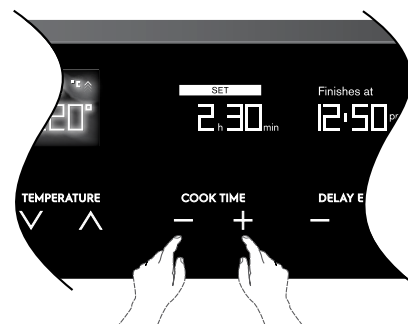

### Start Pyrolytic

Unlike other cooking functions, you **MUST** touch 'OK' for the pyrolytic cycle to start. The display will prompt you to remove all shelves and trays. You must touch 'OK' again to start. The oven light will then go out and the Pyrolytic function will start.



### **i** IMPORTANT

**At the beginning of pyrolytic cleaning the door will automatically lock **🔒** will appear on the display. During the pyrolytic cleaning cycle there may be some burn off odours. It is advised to keep the room well ventilated during this cycle.**

## EVERP616, EVERP618, EVERP626 (CONTINUED)

(EVERP626)

For these models with two ovens, both doors will lock automatically at the beginning of the pyrolytic cleaning. Cooking is not permitted in either oven during the pyrolytic clean function.

The door(s) will only unlock when the oven has cooled to a safe temperature. Turning the function off will not unlock the door(s). This will only happen when safe temperatures are reached.

When the pyrolytic cleaning function is on, it is advisable not to use a cooktop if it is fitted above the oven. This could cause overheating and damage to both appliances.

*NOTE: The cooling fan will operate at an increased speed for Pyrolytic cleaning and will continue to run until the oven has cooled down. This is normal.*

*It is recommended to clean the oven regularly to keep it in its best condition.*

### After Pyrolytic cleaning

After cool-down wipe the ash out of the oven with a soft damp cloth and warm water.

To restore the enamel shine to more difficult areas, use a damp cloth with vinegar and detergent.



### CAUTION

**Do not turn off the mains power supply to the oven during the pyrolytic cycle. This could damage the appliance.**

### Cleaning Reminder

After a recommended period of time the oven will remind you to clean the oven. Once this period of time has elapsed, when turning the oven off you will get a message "TIME TO CLEAN YOUR OVEN". Press the on/off button to clear the message and run the pyrolytic cycle. After the pyrolytic cycle has finished, the cleaning reminder will reset. The "Cleaning Reminder" setting can be enabled/disabled in the settings menu.

Alternatively while the "TIME TO CLEAN YOUR OVEN" message is displayed, you can press the "OK" button and you will get the option to "REMIND ME AGAIN".

## GETTING TO KNOW THE OVEN

### Get to know your new oven with this 'Simple Test Cake'

Although we strive for a perfect performing oven, it's possible that there will be some variation in colour when baking. Therefore, we suggest to make this simple, easy and delicious Simple Test Cake to help you understand your new oven. All ovens do sometimes have hot or cold spots, therefore it is important to judge with your eye as you may require to rotate during baking.

### 'Simple Test Cake'

125g butter, softened to room temperature

1 cup caster sugar

1 teaspoon pure vanilla essence

4 large eggs

2 cups self-raising flour

pinch of salt

4 tablespoons (80mL) full-cream milk

### Method:

1. Butter base and sides of two, 20cm straight-sided round or square cake pans. Then line the base with grease proof or baking paper.
2. Preheat oven to moderate '180°C' (170°C fan forced) and ensure oven shelf is in the centre position of oven.
3. Cream softened butter and sugar until light in colour.
4. Add vanilla essence.
5. Then eggs one at a time, beating well after each addition.
6. Sift flour and salt into the mixture and beat until well combined.
7. Add milk and beat or stir to combine.
8. Spoon mixture equally between prepared cake pans.
9. Bake in preheated oven, middle shelf for about 25 to 35 minutes or until when tested with a fine cake skewer it comes out clean or the edges of the cakes have come away slightly from the sides of the cake pans.
10. Remove from oven to wire cake rack and rest for 5 minutes before removing from cake pans.
11. Cool completely.

### To Serve:

Sandwich together with your favourite jam or conserve, and dust top with pure icing sugar.

*NOTE: if desired substitute butter for either margarine or olive oil spread. Recipe is based on the Australian standard metric 250mL cup and 20mL tablespoon sets.*



### Using the bread baking function (EVEP618 model only)

To aid you in baking bread here is a basic recipe to understand and experiment with the bread baking function.

'Test loaf from base ingredients'

500g wheat flour

10g salt

10g butter at room temperature

280 +/- 20 g water at 37 °C +/- 2 °C

3g sugar

20g fresh yeast

#### Method

1. Weigh wheat flour, salt and butter in mixing bowl of the food processor.
2. Dissolve sugar and yeast in the warm water and add to the flour.
3. If using a mixing machine, mix on slow speed for 2 minutes. Then mix on medium for 8 minutes or until dough is smooth.
4. Shape round ball of 750g of the dough, put in a bowl, cover with cling film and let it rise for 45 minutes in the oven at 30°C (or in defrost mode).
5. Shape a longish loaf, cover with a towel and let it rise for 45 minutes in the oven at 30°C (or in defrost mode).
6. Carve the surface of the bread with a serrated knife, depth of the cuts around 5mm.
7. Choose 'bread baking' function, ensure water is in the tank and pre-heat the oven to 180°C for 10 minutes.
8. Place the dough in shelf level 2 (second from bottom) and cook for 40-45 minutes.
9. Refill the water tank if it becomes empty before the end of the cycle.
10. Remove loaf and allow to cool.
11. Drain any left over water from the tank once the appliance is cool.

#### Cooking guide

- Select the correct shelf location for food being cooked.
- Make sure dishes will fit into the oven before it is switched on.
- Keep edges of non Electrolux baking dishes at least 40mm from the side of the oven. This allows free circulation of heat and ensures even cooking.
- Do not open the oven door more than necessary.

- Do not place foods with a lot of liquid into the oven with other foods. This will cause food to steam and not brown.
- After the oven is turned off it retains the heat for some time. Use this heat to finish custards or to dry bread.
- Do not use a lot of cooking oil when roasting. This will prevent splattering oil on the sides of the oven and the oven door.
- When cooking items that require a high heat (e.g. tarts), place the cooking dish on a scone tray in the desired shelf position.
- For sponges and cakes use aluminium, bright finished or non-stick cookware.

#### Condensation

Excess condensation may fog the oven door. This may happen when you are cooking large quantities of food from a cold start. Minimise condensation by:

- Keeping the amount of water used whilst cooking to a minimum.
- Making sure the oven door is firmly closed.
- Baking custard in a baking dish that is slightly smaller than the water container.
- Cooking casseroles with the lid on.

If water is being used in cooking, it will turn to steam and may condense outside your appliance. This is not a problem or fault with the appliance.

#### Oven shelf location

The oven has 5 positions for shelves (as shown in the diagram below). To give maximum space above and below the shelves, load them in this way:

When cooking with 1 shelf, position at 1 or 2.

When cooking with 2 shelves, position them at 2 and 4.

For more detailed shelf locations. Refer to cooking tables for individual cooking functions.

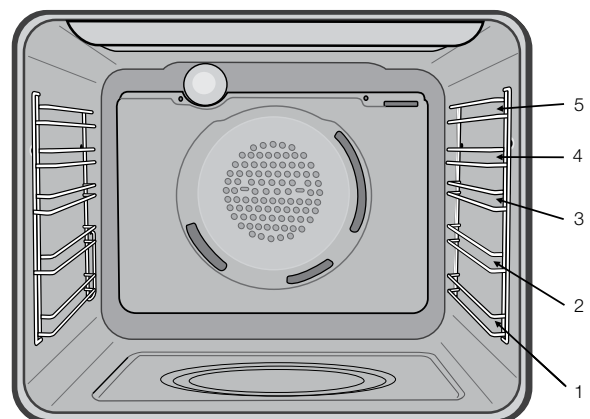

# STEAM ASSISTED COOKING

All Electrolux range of ovens have the ability to add steam while baking, additionally EVEP618 has dedicated steam drawer and functions.

Cooking with steam is a great addition to 'hot air' cooking. Steam brings out all the natural flavours and goodness in the food, cooks evenly from surface to centre and retains more nutrients and vitamins. Steam assisted cooking consistently produces juicy, succulent interiors with crisp, golden exteriors.



## WARNING

### Risk of burns and damage to the appliance

- Do not open the appliance door when the steam function operates, with the exception of preheating.
- Open the appliance door with care after the steam function stops.
- Refer to cleaning the appliance for cleaning after the steam function operates.

## EVE614, EVEP614

1. Open the oven door
2. Add 150ml of tap water to the cavity well. Fill the cavity well with water only when the oven is cold.



3. Set the 'Bake + steam' function.

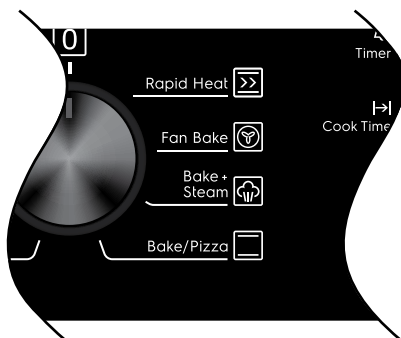

4. Turn the knob for the temperature to select a temperature.
5. Preheat the oven for 10 minutes or according to the recipe suggestions.
6. Place food in the appliance and close the oven door.



## CAUTION

**Do not refill the cavity well with water during cooking or when the oven is hot.**

7. To deactivate the appliance, turn the knob for the oven functions to off position.
8. Remove water from the cavity well.



## WARNING

Make sure that the appliance is cool before you remove the remaining water from the cavity well.

## EVE626, EVE636, EVEP616, EVEP626

1. Open the oven door
2. Add 150ml of tap water to the cavity well. Fill the cavity well with water only when the oven is cold.
3. Set the 'Fan cooking' function.

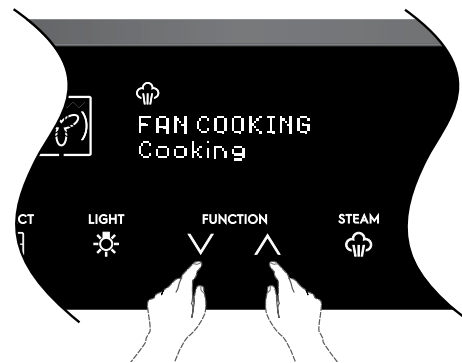

4. Activate the Steam button by touching . The steam control works only with the 'Fan cooking' function. The indicator turns on .
5. Set the temperature using .
6. Preheat the oven for 10 minutes or according to the recipe suggestions.
7. Place food in the appliance and close the oven door.



## CAUTION

**Do not refill the cavity well with water during cooking or when the oven is hot**







## WARNING

**Make sure that the appliance is cool before you remove the remaining water from the cavity well.**

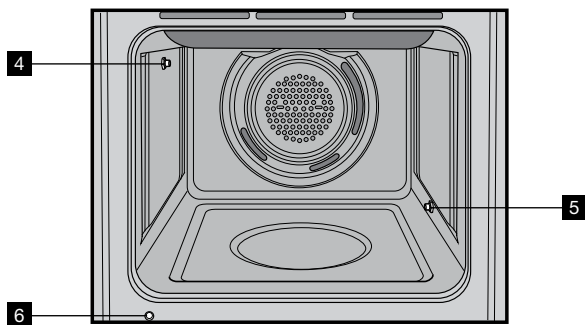
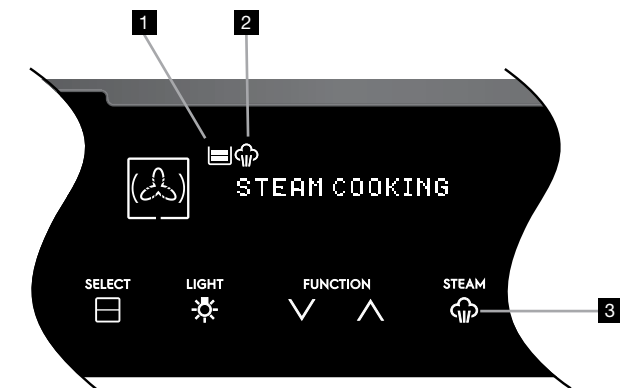
## EVEP618

### Steam product description



- 1** Water tank Level Indicator
  -  – Tank empty.
  -  – Water present.
  -  – Tank full. Overfill alarm will sound. Press 'OK' to continue.
- 2** Steam function in progress.
- 3** Steam On Demand. Available for certain functions only.
- 4** Steam outlet. This is where steam is injected into the oven.
- 5** Water overflow pipe. If the water tank is over filled, water will be dispensed into the oven from here. This is not a fault with the appliance. It prevents water spilling out of the water drawer which could create a hazard. If this occurs mop up the overflow with a clean cloth and continue with the cooking function.
- 6** Water outlet valve. To be used with the draining pipe (supplied). Any water left in the tank is to be drained after the appliance has cooled down.

### Steam operating sequence

1. Open the water drawer in the control panel by pressing it.
2. Pour approximately 850mL of water into the drawer. The water level indicator on the display will show one to two bars. Close the water drawer.

#### **WARNING**

Take care when filling the water drawer. Spillage could create a slipping hazard. Immediately clean up any spills on the product, cabinet or floor. If the overfill alarm sounds immediately stop pouring water into the water drawer. If the tank is overfilled the excess will flow into the oven. This prevents leakage onto cabinets and is not a fault. Sponge up overflows if they occur.

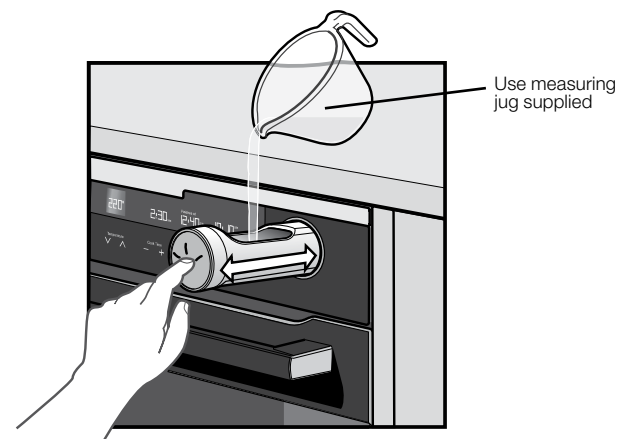

#### **CAUTION**

Do not use any liquid other than normal tap water. Do not use demineralised or distilled water. Doing so could affect the normal operation of the steam generator. Do not put solid matter into the water drawer.

1. Turn on the oven and select the steam cooking function and temperature as per normal operation. Set timer functions if desired.
2. Once the oven has reached the desired temperature put the food in and cook as planned. A full water tank will last approximately 30 minutes. It may have to be refilled during a long cooking cycle, for example, a roast.
3. Once cooking is complete remove the food and turn off the oven. Leave the oven door ajar to aid drying of the oven.
4. Drain water tank once the appliance is cool.

#### **WARNING**

The steam is not visible inside the oven but it is there. Opening the oven door to place, remove or inspect food will release it. Stand back when opening the door to avoid the risk of burns.

# STEAM ASSISTED COOKING (CONTINUED)

## Emptying the water tank

The water tank must be emptied after every steam assisted cooking cycle. This is done by:

1. Open the oven door to reveal the water outlet valve.
2. Insert the valve end of the supplied drain pipe into the water outlet valve. Ensure the other end is in a container that can take up to 1 litre.
3. Remove the drain pipe only when the water stops flowing.
4. Soak up any leakages with a sponge or cloth.



### WARNING

**Water in the tank can still be hot. Wait until the appliance is cool before the water tank is drained.**

**Do not use the drained water to fill the water tank again.**

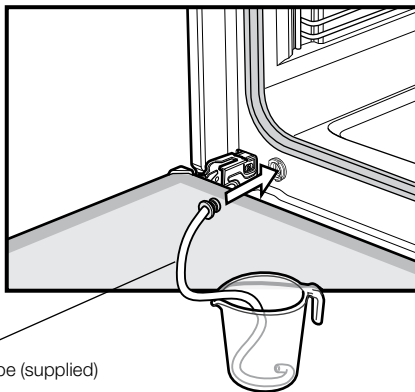

Drain pipe (supplied)

This model has three dedicated steam functions that have been individually tuned to produce the best result with a combination of steam and heat application.

They are:

#### Steam cooking

Perfect for all kinds meat, poultry and fish dishes. The hot air ensures the outside is sealed whilst the steam keeps the inside tender.

#### Steam reheat

Rejuvenates food like it was just cooked. Great for reheating dishes like rice, pasta and pizza that can suffer from dryness in normal ovens or sogginess in microwave ovens.

#### Bread baking

Specially programmed for buns and loaves of bread. This function gives perfect, fluffy insides with crisp golden crusts. See 'getting to know your oven' on page 40 for directions of use.

## Steam on demand

During the cooking process some functions will allow the user to switch between standard cooking and steam assisted cooking. This is useful if the food is drying out or the meal requires a higher retention of moisture. Steam can be introduced by pressing the  symbol. This option is available for the following functions:

- Fan cooking
- Fan assist bake
- Roast
- Pizza
- Cook from frozen

It will always be possible to switch back to standard cooking by again pressing the  symbol.

*NOTE: the ability to switch between steam and standard cooking is only available on the above functions. Pressing the  symbol on any other function will have no effect. Steam can only be generated if there is water in the tank and the oven temperature is over 130°C.*

# USING THE FOOD PROBE

The Food Probe measures the core temperature of the food. When the food reaches the desired set core temperature, the oven turns off. The Food Probe has a core temperature range of 50-99°C.

There are two temperatures to set:

- The oven temperature
- The core temperature of the food

## WARNING



**Only use the Food Probe supplied or the correct replacement parts.**

*NOTE: Food must be completely defrosted when inserting the Food Probe. If the food is too cold, the Food Probe function will not work.*

## ALL FOOD PROBE MODELS EXCEPT EVEP614

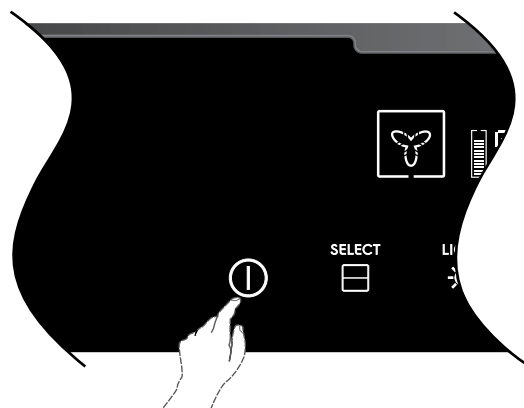

1. Switch on the oven by touching the  symbol.

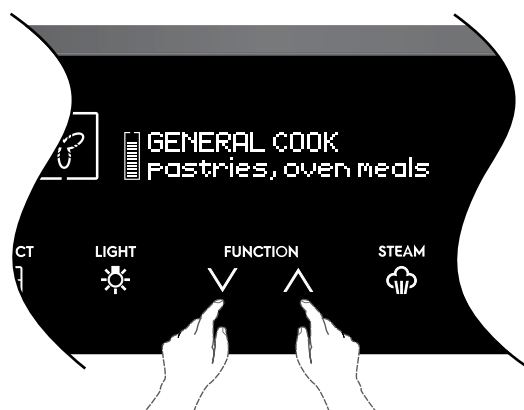

2. Select a cooking function by pressing the function  or function  as many times as necessary until the desired function appears.



*NOTE: When using the Food Probe, the duration and end time functions do not operate.*

3. Select the oven temperature by pressing the temperature  or temperature  to reach the desired setting. Allow oven to preheat.

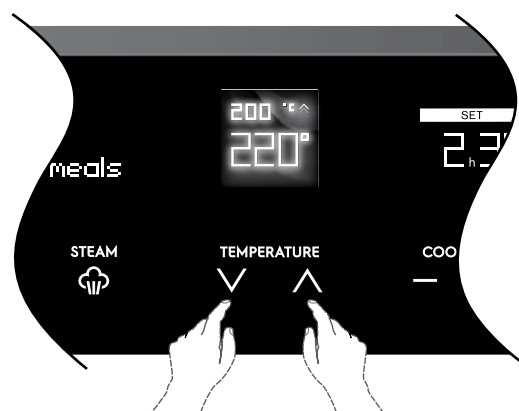

4. Put the tip of the Food Probe into the centre of the food, with at least 75% of the probe inserted into the food.

### Meat

For large pieces of meat, insert the tip of the Food Probe into the centre of the meat, with at least 75% of the probe inserted into the meat.

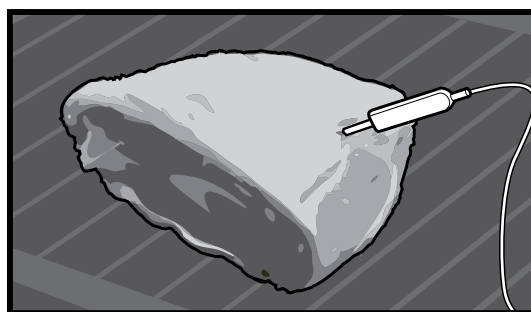

### Fish

For best results, place the whole fish onto the wire rack and prop it up in the swimming position (i.e. using half a potato or onion). Alternatively the fish can be laid flat. Insert the Food Probe behind the head with at least 75% of the probe inserted into the fish towards the bones in the middle of the fish.

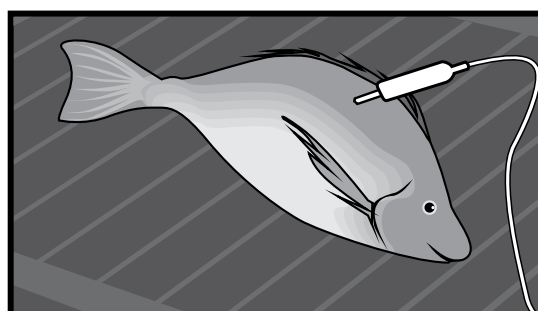

## USING FOOD PROBE (CONTINUED)

### Poultry

Place the whole poultry on the wire rack breast side up. Insert the Food Probe with at least 75% of the probe into the breast of the poultry. Place the probe in a direction toward the neck end of the poultry.

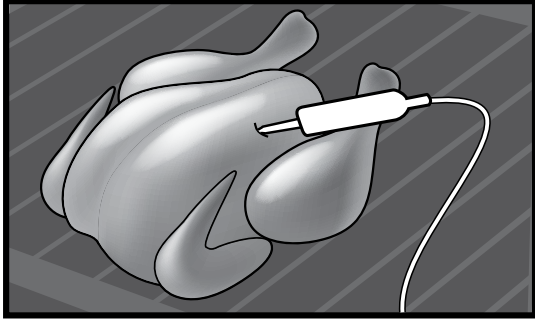

### ! CAUTION

To prevent the Food Probe from being damaged by excessive heat, there must be a gap of a few centimetres between the grill element and the Food Probe. The meat may expand during the cooking process.

- Put the plug of the Food Probe into the socket on the top right hand corner of the front frame. Ensure plug is fully inserted into the socket.

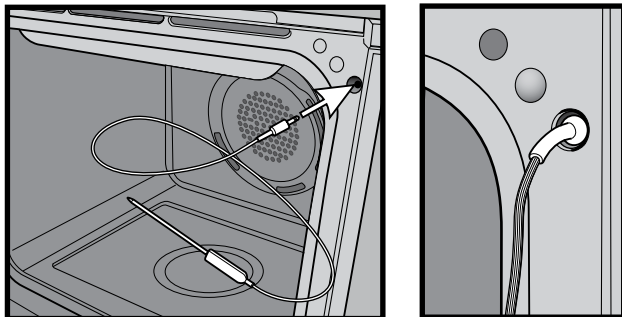

### ! CAUTION

After pre-heating, the front of the oven will be hot. Care should be taken when inserting the food probe plug.

*NOTE: The Food Probe will only work for the following functions*

- Fan cooking
- Steam cooking (EVEP618 only)
- Traditional bake
- Fan assist bake
- Roast

If you have selected a function that is not compatible with the Food Probe, you will see the message "REMOVE FOOD PROBE".

- Set the desired food core temperature by pressing the temperature  $\wedge$  or temperature  $\vee$  to reach the desired setting.

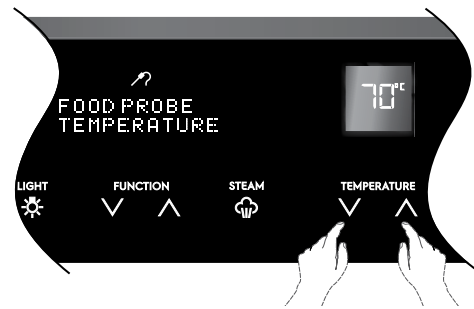

### Core temperatures of different foods

The temperatures in the table are given as a guide and may vary depending on the composition of the food.

Food	Core Temperature in °C
<b>Poultry</b>	
Chicken	80-85
Chicken breast	75-80
Duck	80-85
Duck breast, rare to medium rare	55-60
Turkey	80-85
Turkey breast	80-85
Goose	80-90
<b>Pork</b>	
Shoulder of pork	85-90
Fillet of pork, rare to medium rare	62-70
Loin of pork, well done	72-80
<b>Beef</b>	
Tenderloin or sirloin, rare	45-52
Tenderloin or sirloin, medium rare to medium	55-62
Tenderloin or sirloin, well done	65-75
<b>Veal *</b>	
Joint of veal or shoulder, lean	75-80
Joint of veal, shoulder	75-80
knuckle of veal	85-90
<b>Lamb **</b>	
Leg of lamb, medium rare	60-65
Leg or lamb, well done	70-80
Saddle of lamb, medium rare	55-60
<b>Fish</b>	
Whole fish	65-70
Fish fillet	60-65
<b>Miscellaneous</b>	
Meat loaf, all kinds	80-90

\* Veal core temperatures are for well done.

\*\* Lamb temperatures are for cuts of Lamb with the bone still in. For boneless, cooking times will be slightly less.

*NOTE: The oven temperature needs to be set at least 10° higher than the desired food core temperature.*

7. The appliance will calculate the approximate end time. The end time is different for different quantities of food, set oven temperatures and function modes.

*NOTE: The estimated end time will be displayed after approximately 30 minutes.*

*NOTE: The Food Probe temperature will not be displayed until the oven is at the desired temperature. Once the oven is at the desired temperature, the Food Probe temperature will cycle between the desired food core temperature and the actual food core temperature.*

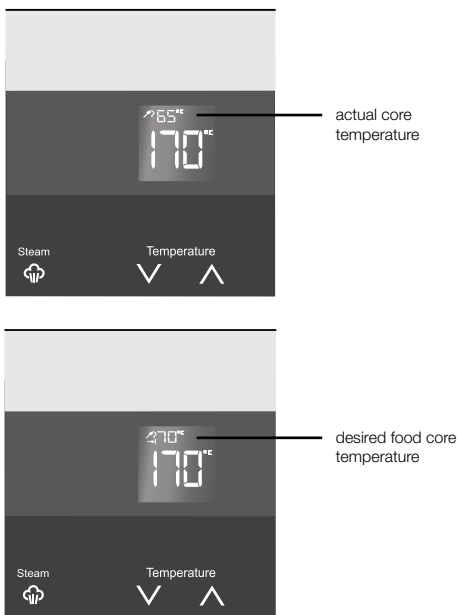

*NOTE: The end time/cook time function cannot be set whilst using the Food Probe function.*

8. When the food is at the desired food core temperature, an audible signal will sound for 2 minutes. To stop the signal, press the **⏸** symbol on the control panel.
9. Remove the Food Probe plug from the socket and remove the food from the oven.

**NOTE: All meat/fish/poultry should be rested, covered for at least 10 minutes.**



### CAUTION

**Always check if food is cooked throughout before eating.**



### WARNING

**After use, always remove the Food Probe from the oven cavity.**



### WARNING

**The Food Probe is hot. There is a risk of burns. Be careful when you remove the tip and plug of the Food Probe.**

To change the desired food core temperature during cooking, press and hold the **✓** and **▲** at the same time.

To cancel the Food Probe operation, simply unplug the probe from the socket.

## USING THE FOOD PROBE: MODEL EVEP614

1. Turn function knob to the desired function

*NOTE: The food probe will only work with the following functions.*

- Fan Bake
- Bake + Steam
- Bake
- Pastry
- Pizza
- Fan grill

2. Set the temperature using the temperature selector knob.
3. Put the tip of food probe into the centre of the food, with at least 75% of the probe inserted into the food, and then place food into the oven.
4. Put the plug of the Food Probe into the socket on the top right hand corner of the front frame. Ensure plug is fully inserted into the socket. The food probe icon and set temperature begin flashing. While the display is flashing, the food probe set temperature can be set using the temperature selector knob.
5. Touch the **°C** symbol to toggle through oven temperature – oven set temperature – Food Probe temperature – Food Probe set temperature. The oven set temperature and the Food Probe set temperature can be adjusted this way. The display will default to the Food Probe temperature.
6. Once the food has reached the set temperature, the oven will beep to notify. Touch any of the symbols to stop beep.
7. Remove the Food Probe plug from the socket and remove the food from the oven.

# COOKING GUIDE



## ENVIRONMENT!

To save energy and to help protect the environment, we recommend these hints:

Use the oven efficiently by cooking many trays of food at the same time. For example:

- Cook 2 trays of scones, small cakes or sausage rolls.
- Cook a roast dinner at the same time as you cook chips or vegetables.

### Roasting meat (use roasting tray & insert)

- Place the meat in the oven and set the temperature between 180°C and 200°C. (It is recommended to wrap your meats in an oven roasting bag or foil to prevent fats and oils from splattering. This will make it easier to clean the oven.)
- Use the grill/oven dish.
- Do not pierce the meat.
- When the meat is cooked, take the roast out of the oven, wrap in aluminium foil and leave to stand for about 10 minutes. This will help retain the juices when the meat is carved. The table below shows temperatures and cooking times for different kinds of meat. These may vary depending on the thickness and bone content of the meat.

### Roasting poultry and fish

- Place the poultry or fish in an oven set at a moderate temperature of 180°C-200°C.
- Place a layer of foil over the fish for about three quarters of the cooking time. The table shows the temperatures and the cooking times for different kinds of fish and poultry. These may vary depending on the thickness and bone content of the meat.

## Cooking guide

meat	recommended temperature °C	minutes per kg
beef	200	rare: 35-40
		medium: 45-50
		well done 55-60
lamb	200	medium: 40
		well done 60
veal	180	well done 60
pork	200	well done 60

poultry & fish	recommended temperature °C	minutes per kg
chicken	200	45-50
duck	200	60-70
turkey	180	40-45 (<10kg)
		35-40 (>10kg)
fish	180	20



## IMPORTANT

**For best cooking results pre-heat your oven and grill. Pre-heating reaches the required temperature quickly and efficiently as well as cook your food at the correct temperature for the entire cook time. When not using steam, for best baking results preheat oven for 30 minutes.**

### Temperature estimations

If a recipe calls for Fahrenheit (°F) or no actual temperatures, use the following table to determine the temperature (°C).

oven		temp. °C	temp. °F
low heat	cool	80	175
	very slow	100-110	210-230
	slow	130-140	265-285
moderate heat	moderately slow	150-160	300-320
	moderate	170-180	340-355
	moderately hot	190-200	375-390
high heat	hot	200-210	390-410
	very hot	220-230	430-450
	extremely hot	240-250	465-480



## TRADITIONAL BAKING

<b>food</b>		<b>temperature °c</b>	<b>oven shelf position*</b>	<b>time in minutes</b>
scones	– plain or fruit	220	1	10
biscuits	– rolled	170	1	10-15
	– spooned	190	1	12-15
	– shortbread biscuits	160	1	30-35
meringues	– hard – individual	110	1	90
	– soft – individual	180	1	15-20
	– pavlova – 4 egg whites	110	1	75
cakes	– patty cakes	190	1	15-20
	– sponge – 4 eggs	180	1	20-30
	– shallow butter cake	180	1	30-40
	– boiled fruit cake	180	1	60-70
pastry – shortcrust	– cornish pasties	200	1	40-45
	– custard tart	200/180	1	10/30-30
pastry – choux	– cream puffs	210	1	25-30
yeast goods	– bread	210	1	25-30
	– pizza	220	1	18

\*Counting from the bottom position up

## FAN COOKING

<b>food</b>		<b>temperature °c</b>	<b>oven shelf position*</b>	<b>time in minutes</b>
scones	– plain or fruit	210	1 and 4	10-15
biscuits	– rolled	150	any	10-15
	– spooned	180	any	10-15
	– shortbread biscuits	150	any	10-15
meringues	– hard – individual	100	any	90
	– soft – individual	165	any	15-20
	– pavlova – 4 egg whites	100	1 and 4	75
cakes	– patty cakes	180	1 and 4	15-20
	– sponge – 4 eggs	170	1 and 4	20-30
	– shallow butter cake	170	any	30-40
	– boiled fruit cake	170	1	60-70
pastry – shortcrust	– cornish pasties	180	any	40-45
	– custard tart	190/170	any	20-30
pastry – choux	– cream puffs	200	any	25-30
yeast goods	– bread	210	1	25-30
	– pizza	220	1	18

# COOKING GUIDE (CONTINUED)

## STEAM COOKING



### IMPORTANT

For best results, preheat oven for 10 minutes. Refer to steam assisted cooking section for details.

#### Bake + Steam function

(EVE614, EVE616, EVEP614, EVEP616, EVE626, EVEP626, EVE636)

food		Water on cavity bottom (ml)	Temperature °C	Oven shelf position*	Time in minutes
Yeast goods	Bread loaves	150	180-200	2	35 - 45
	Bread rolls	150	190-210	2	20 - 25
	Glutenfree bread	150	180-200	2	40 - 50
	Pizza (fresh)	150	210-220	2	15 - 20
	Focaccia	150	200-210	2	20 - 30
Biscuits	Rolled	150	160-170	2	10 - 15
	Spooned	150	160-170	2	10 - 15
Scones	Plain or fruit	150	200-210	2	10 - 15
Cakes	Cupcakes	150	180	2	20 - 25
	Sponge - 4 eggs	150	170	2	20 - 30
	Shallow butter cake	150	170	2	25 - 30
Pastry - choux	Cream puffs	150	200	2	20 - 30
Puff pastry		150	200	2	15-20
Frozen croissants		150	170-180	2	15-25

\*Counting from the bottom position up

#### Steam function (EVEP618 model only)

food		temperature °C	oven shelf position*	time in minutes
cakes and pastries	– apple cakes in a 20cm cake tin	140	1	60-80
	– biscuits on a baking tray	150	2 (1 and 3)	20-40
	– sweet buns on a baking tray	180-200	1	10-20
flan	– vegetable in a dish	170-180	1	20-40
	– lasagne in a dish	170-180	1	40-50
	– potato gratin in a dish	160-170	1	50-60
meat	– roast pork	180-200	1	90-110/kg
	– veal	180	1	35-45/kg
	– roast beef			
	• rare	210	1	35-40/kg
	• medium	200	1	40-45/kg
	• well done	190	1	50-55/kg
	– whole chicken	200	1	50-55/kg
fish and seafood	– snapper 1-1.5kg	140-150	1	15-25
	– barramundi 4 fillets	180	1	10-15
miscellaneous	tray of vegetables 500g	130	1	20-25
	pizza (fresh)	210	1	14-18

\*Counting from the bottom position up

## BREAD BAKING

food		temperature °c	oven shelf position*	time in minutes
bread	– rolls	200	1	20-25
	– loaves	180	1	35-45
	– foccacia	200-210	1	15-25

## GRILLING

### Grilling hints

As a method of cooking, grilling can be used to:

- Enhance the flavours of vegetables, fish, poultry and meat.
- Seal the surface of the food and retain natural juices.
- Grill with the door closed.

This table shows how to grill different types of meat:

food	grilling method
beef – tenderloin, rump and sirloin.	brush with oil or melted butter, especially if the meat is very lean
lamb – loin chops, shortloin chops, chump chops and forequarter chops.	remove skin or cut at intervals to avoid curling. brush with oil or melted butter
sausages	prick sausages to stop skin from bursting
poultry	divide into serving pieces. brush with oil
fish	brush with oil or melted butter and lemon juice
bacon	remove rind, grill flat and make into rolls



### WARNING

**Always clean the grill/oven dish after every use. Excessive fat build up may cause a fire.**

### Guide to better grilling

No definite times can be given for grilling because this depends on your own tastes and the size of the food. These times should only be used as a guide and remember to turn the food over half way through the cooking process.

food	time in minutes
Steak	15-20
Chops	20-30
Fish	8-10
Bacon	4-5

For better grilling results, follow these easy instructions:

- Remove oven/grill dish and grill shelf and preheat grill for about 5 minutes.
- Choose only prime cuts of meat or fish. If the cut is less than 5mm thick it will dry out. If the cut is more than 40mm thick, the outside may burn whilst the inside remains raw.



### WARNING

**Do not place aluminium foil under food as this prevents fats and oils from draining away, which could result in a fire.**

- Baste the food during grilling with butter, olive oil or marinade. Grilled food is better if marinated before cooking.
- Use tongs to turn food as a fork pierces the surface and will let juices escape.

### Fan grill

The 'fan grill' function will assist the grilling process by circulating the heat evenly around the food. The recommended temperature setting is 180°C for all fan grilling functions.

Use the grill shelf with dish below for all fan grilling. Position the shelf in the lower half of the oven for the best results.

Wipe off any oil or fat which splatters while the oven is still warm.

There is no need to turn meat as both sides are cooked at the same time which means the food is succulent.

# DEALING WITH COOKING PROBLEMS

<b>problem</b>	<b>possible causes</b>	<b>remedies</b>
Uneven cooking	Incorrect shelf position	• Select shelf suitable for cooking function. See cooking function tables in cooking guide
	Oven tray too large	• Experiment with other trays or dishes
	Trays not centralised	• Centre trays
	Air flow in oven uneven	• Rotate food during cooking
	Grill dish affecting thermostat	• Remove grill dish from oven on bake modes
Baked products too brown on top	Oven not preheated	• Preheat oven
	Baking tins too large for the recipe	• Use correct size tins
	Baking tins not evenly spaced	• Stagger baking tins at least 3cm between tins and oven walls
	Products not evenly sized or spaced on trays	• Make into same size and shape, and spread evenly over trays
Baked products too brown on bottom	Baking temperature too high	• Lower the temperature
	Baking tins too large for the recipe	• Use correct size tins
	Baking tins are a dark metal or glass	• Change to shiny, light tins or lower the temp by 10°C
	Food too low in the oven	• Cook one shelf higher
	Oven door opened too frequently during baking	• Don't open the door until at least half the cooking time has passed
Cakes have a cracked thin crust	Baking temperature too high	• Lower the temperature
	Food too high in oven	• Cook one shelf lower
	Cake batter over mixed	• Mix just long enough to combine ingredients
	Pan too deep	• Check size of pan
	Baking pans dark	• Change to shiny pans
Baked products are pale, flat and undercooked	Baking temperature too low	• Raise the temperature
	Food too low in oven	• Cook one shelf higher
	Baking time too short	• Increase the cooking time
	Incorrect size tin	• Use the correct size tin
Cakes fallen in the centre	Baking temperature too low	• Raise the temperature
	Baking time too short	• Increase the cooking time
	Proportions of ingredients incorrect	• Check recipe
	Door opened too early in baking	• Do not open door until the last quarter of cooking time
Roast meat, potatoes not browning in fan oven	Poor air circulation	• Elevate food onto a rack to allow air circulation
	Grill dish affecting thermostat	• Remove grill dish from oven on bake modes
	Juices running out of meat	• Do not pierce meat with a fork
Grilled meats outside is overcooked and centre is raw		• Grill in a lower position
Grilled chops and steaks curling		• Cut into fat every 2cm
The steam cooking does not operate	There is no water in the tank	• Fill the water tank
	Limescale is obstructing the hole	• Check the steam outlet opening and remove the lime
It takes more than three minutes to empty the water tank or the water tank leaks from the steam outlet	There are lime deposits in the appliance	• Check the water tank and refer to the chapter on Cleaning the water tank.
Steam and condensation settle on the food and in the appliance	The dish has been left in the oven for too long	• Do not keep the dishes in the appliance for longer than 15-20 minutes after the cooking ends
Food Probe function will not display when plugged in		• Ensure food is fully defrosted

# CLEANING THE APPLIANCE



## WARNING

- **Do not use steam cleaners.**
- **Do not line the bottom of the oven with foil or cookware.**

## Stainless steel

All grades of stainless steel can stain, discolour or become greasy. You must clean these areas regularly by following the procedures below, if you want your appliance to look its best, perform well and have a long life.

**Care must be taken when wiping exposed stainless steel edges, they can be sharp!**

A suitable cleaner can be purchased from Electrolux Customer Care Centres.



## CAUTION

The oven door and control panel are decorated with a special stainless steel that resists finger marks and should only be cleaned with warm water and a mild detergent.

DO NOT use stainless steel cleaners, abrasive cleaners or harsh solvents.

*NOTE: Make sure you follow the polish or brushing lines in the steel.*

## Glass

- Glass surfaces on doors and control panels are best cleaned immediately after soiling.
- A damp cloth may help remove baked on food deposits.
- Oven cleaners can be used to remove stubborn marks and stains.



## WARNING

**The door glass on this appliance is made from a tough, durable material that withstands heating and cooling without breaking. However, it must be remembered that it is GLASS, it may break. Treat it accordingly! Should you have any questions about the glass in your new appliance, please contact the customer care centre by dialling 1300 363 640.**

**Do not use harsh abrasive cleaners or sharp metal scrapers to clean the oven door since they can scratch the surface, which may result in shattering of the glass.**

## Oven

- Always keep the appliance clean. Ensure fats and oils do not accumulate around elements, burners or fans.
- Always keep oven dish, bake trays and grill dish inserts clean, as any fat deposits may catch fire.
- It is recommended to wrap meats in foil or an oven roasting bag to minimise cleaning.
- Any polyunsaturated fats can leave a varnish-like residue which is very difficult to remove.

## Grill

- Always keep grill dish clean, as any fat deposits may catch fire.

## Food Probe (selected models only)

- Clean the Food Probe after each use and let it dry. Use a soft cloth with warm water and a cleaning agent. Only clean the probe end and not the plug.

## Cleaning the cavity well

The cleaning procedure removes limestone residue from the cavity well after cooking with steam.



## WARNING

**Perform the cleaning procedure at least every 5 Bake + Steam cooking cycles.**

1. Mix 150ml of tap water with 100 ml of white vinegar and put the mix in the cavity well.
2. Let the water+vinegar-mix dissolve the limestone residue at the ambient temperature for 45 minutes.
3. Remove the water+vinegar-mix with a soft cloth and clean the cavity with warm water and a soft cloth.

# CLEANING THE APPLIANCE (CONTINUED)

## CLEANING THE ACCESSORIES

### Removing the trays and shelves from the appliance

1. Slide the tray and shelves towards you until they reach the front stop.
2. Tilt them up at the front to clear the side supports, taking care not to spill the contents.
3. Lift them clear.
4. Wash the tray and shelves in hot soapy water.
5. Reverse the above steps to put the tray and shelves back again.
6. Ensure that they are placed between two support wires.
7. To remove a shelf from slides:
  - Pull shelf towards you until it stops.
  - Lift the shelf clear.

### Removing the side racks

1. Grasp the middle wire at the front.
2. Pull firmly inwards while pushing back.

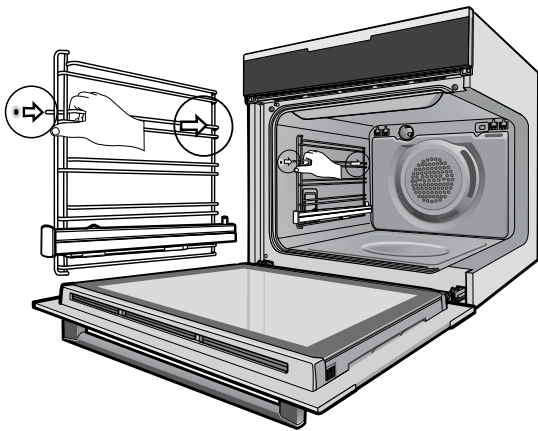

### Slides (Telescopic runners)

- Do not subject slides to temperatures greater than 300°C.
- Do not place slides in a dishwasher
- Do not use a knife or sharp object to clean slides.
- Do not add oil or any other lubricant to slides.

### WARNING

Make sure the appliance is turned off before you remove or replace parts to avoid the possibility of electric shock.

### Removing and replacing the oven back light and side light (if fitted)

- Turn oven light glass anti-clockwise to remove it for globe replacement.
- To remove side light, place a spoon under the light glass and lever off. Replace globe and snap glass cover back into position.
- A special high temperature resistant globe should be used. This can be purchased from Electrolux Customer Care Centres.

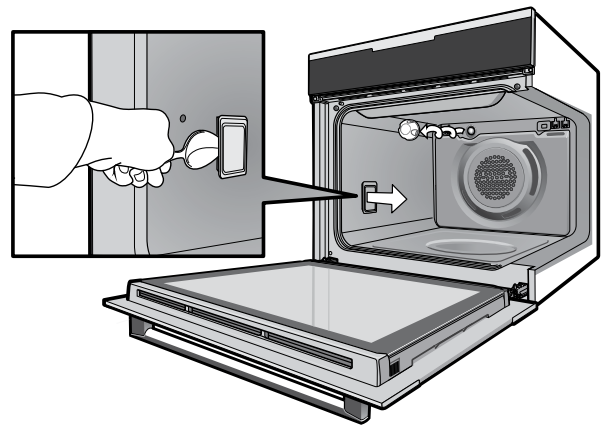

### Releasing the grill element

To clean the oven roof, rotate latch until the element drops down freely.

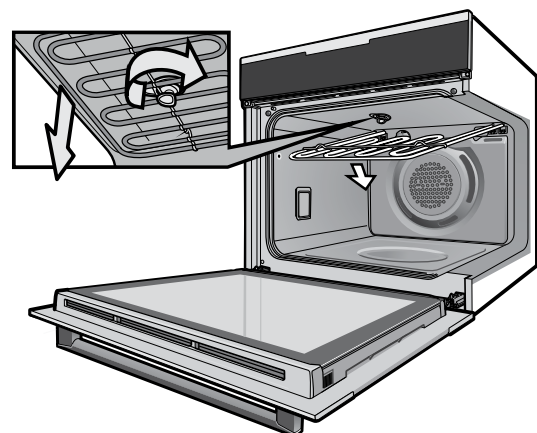

## CLEANING THE TRIPLE GLAZED DOOR (NON PYROLYTIC MODELS)



### WARNING

**Do not lift the door by the handle. Rough handling will cause glass to break.**

### Removing the oven door

The oven is equipped with a door that can be disassembled in order to clean all the panes of glass.

Remove the door before cleaning.

1. Open the door fully to access the hinges then rotate the 'stirrups' (highlighted in the diagram) on both hinges fully towards the oven.

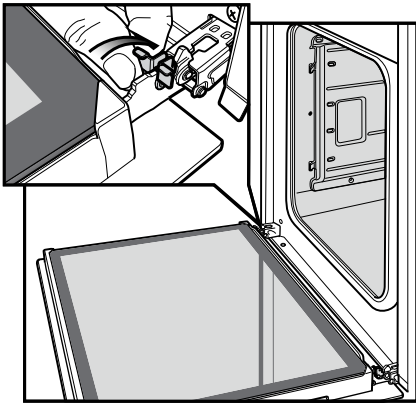

2. Slowly close the oven door until it stops against the 'stirrups' (about 45°).

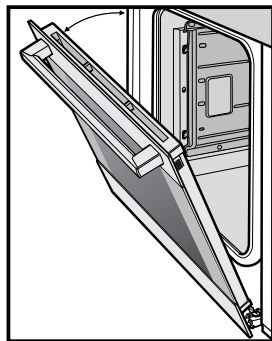

3. Grasp the oven door with a hand each side of the door and remove it from the oven by pulling it towards you.

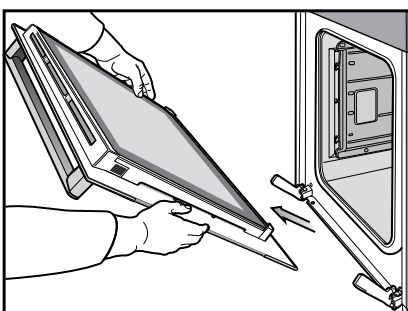

4. Lay the oven door with the outer side facing downwards on something soft and flat (for example a cloth/towel on a kitchen bench/table) to prevent scratches.

### Removing the oven door top trim

- Take hold of the grid embossed sections of the door trim at each end and press inwards to release the clips. Remove the door trim by pulling it towards you.

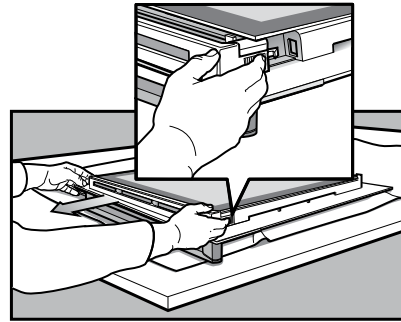

### Removing door glass panels



### WARNING

**Rough handling, especially around the edges can cause the glass to break.**

- Lift the black bordered glass panel out of the guide.
- Repeat this for the smaller clear glass panel.

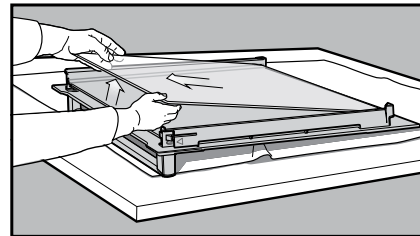

### Cleaning the door glass panels



### CAUTION

- **Do not use harsh abrasives on the glass panes as the reflective surface plays a role in the function of the oven to keep the door cool.**
- **Do not place glass in dishwasher. Hand wash only with a soft cloth and warm soapy water. When dry polish with a soft cloth and ensure the glass is dry before reassembly.**
- **Be careful not to hit the corners of the glass on the benchtop as the glass may break.**

# CLEANING THE APPLIANCE (CONTINUED)

## Replacing the door glass panels

1. Insert the smaller clear glass panel first from above and at an angle to the profile of the door.

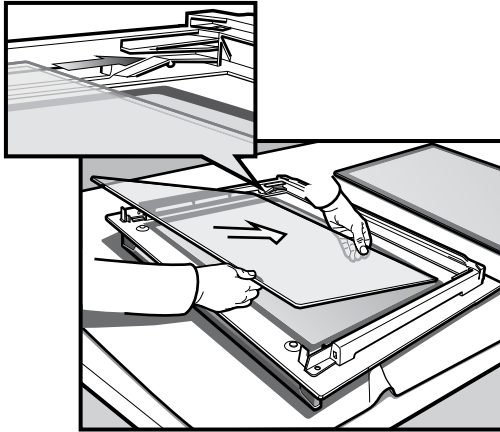

2. Repeat for the black bordered glass panel ensuring the painted surface is facing to the downside.

## Replacing the top door trim

1. Take hold of the top door trim at each side and position it to the inside edge of the glass.
2. Push the trim down with its top edge over glass panel until the clip snaps in on each side of the trim.

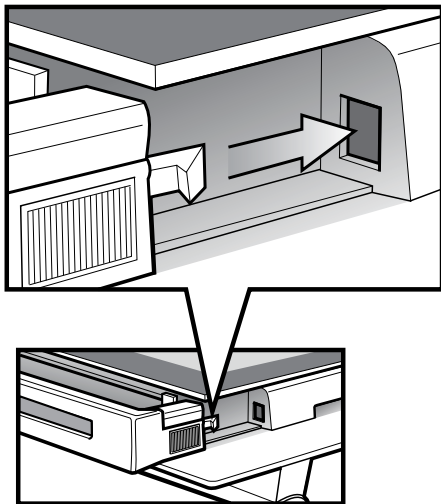

3. Push the middle of the trim down to ensure it is straight and firm against the glass panel.

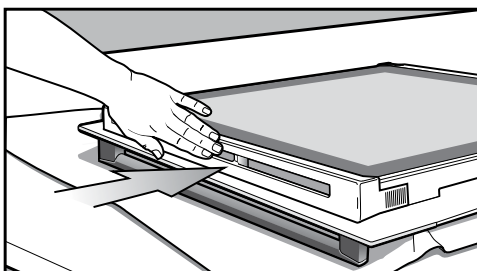

## Fitting the oven door

1. Take hold of the oven door with a hand on each side and with the door at an angle of 45°, position the recesses at the bottom of the door onto the hinge arms of the oven. Let the door slide down the hinge arms as far as it will go.

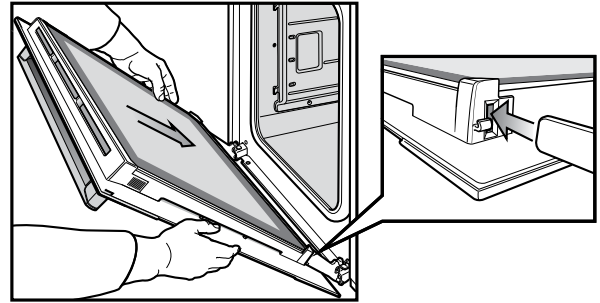

2. Open the door fully to access the hinges.
3. Rotate the 'stirrups' (see the diagram below) until they lock into the hook. The oven door may now be closed.

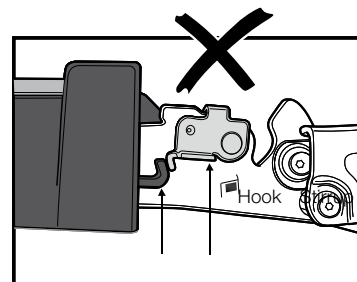
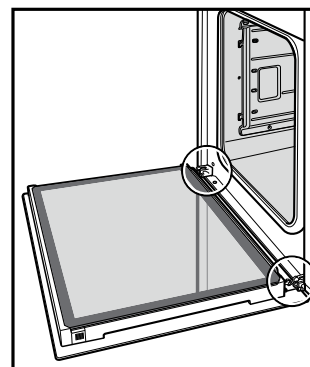
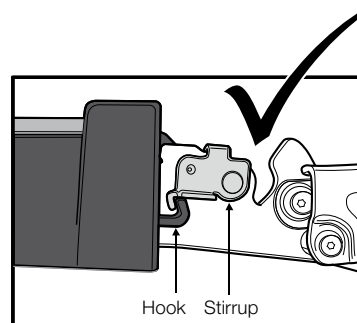



## CLEANING THE QUAD GLAZED DOOR (PYROLYTIC MODELS)

### **WARNING**

**Do not lift the door by the handle. Rough handling will cause glass to break.**

### Removing the oven door

The oven is equipped with a door that can be disassembled in order to clean all the panes of glass.

Remove the door before cleaning.

1. Open the door fully to access the hinges then rotate the 'stirrups' (highlighted in the diagram) on both hinges fully to open position.

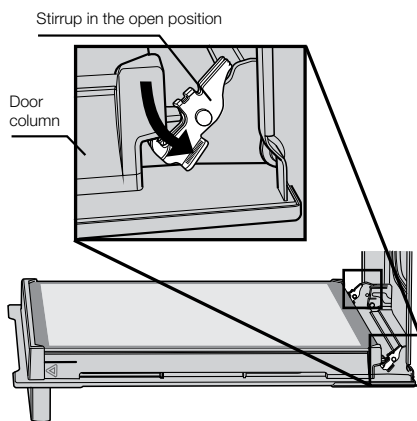

2. Slowly close the oven door until it stops against the 'stirrups' (about 30°).

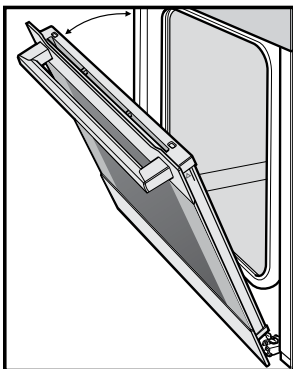

3. Hold the oven door with a hand each side and remove it from the oven by pulling it towards you.

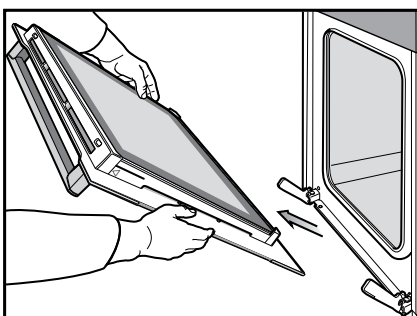

4. Lay the oven door with the outer side facing downwards on something soft and flat (for example a cloth/towel on a kitchen bench/table) to prevent scratches.

### Removing the oven door top trim

- Hold the embossed sections of the door columns at each end and press inwards to release the clips. Remove the upper door trim by pulling it towards you.

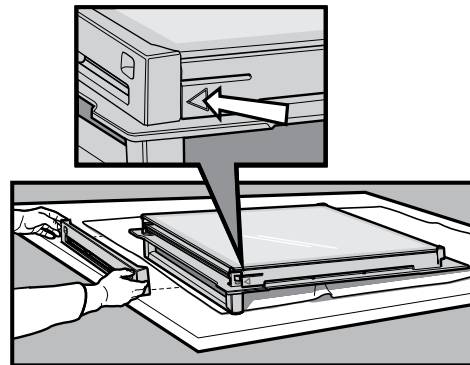

### Removing door glass panels

### **WARNING**

**Rough handling, especially around the edges can cause the glass to break.**

- Lift the black bordered glass panel out of the guide.
- Repeat this for the smaller clear glass panels.
- When removing panel 3, ensure that the two rubber spacers are removed before cleaning. Do not misplace them!

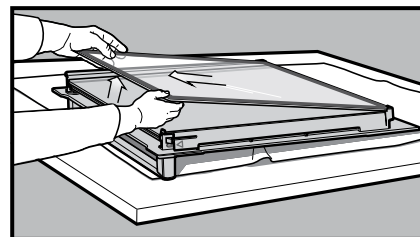

### **CAUTION**

- **Do not to use harsh abrasives on the glass panes as the reflective surface plays a role in the function of the oven.**
- **Do not place glass in dishwasher. Hand wash only with a soft cloth and warm soapy water. When dry, polish with a soft cloth and ensure the glass is dry before reassembly.**
- **Be careful not to hit the corner of the glass on the benchtop as the glass may break.**

# CLEANING THE APPLIANCE (CONTINUED)

## Replacing door glass panels

1. Assemble the silicone spacers to the upper corners of one of the clear glass panels. Position the panel into the lower position of the door, ensuring the chamfered corner of the panel is placed in the correct location as shown in the image below.

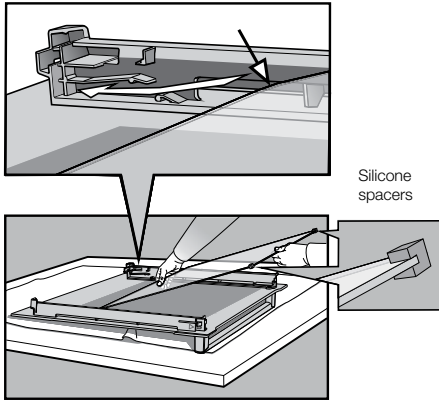

2. Insert the remaining smaller clear glass panel into the middle position, ensuring the chamfered corner of the panel is placed in the correct location as shown in the image below.

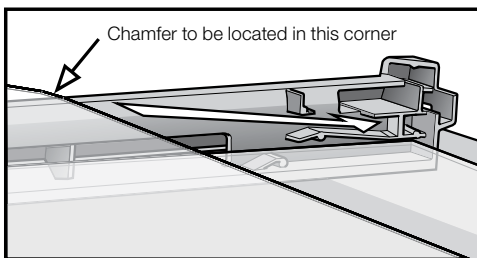

3. Insert the black bordered glass panel into the upper position, ensuring the painted surface is facing the downside as per the image below.

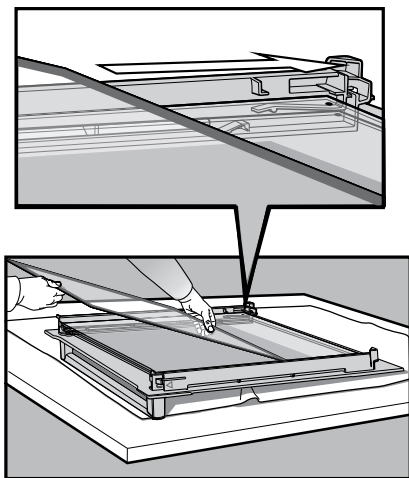

## Replacing the top door trim

1. Hold the top door trim at each side and position it to the inside edge of the glass with trim vent opening closest to glass.

2. Push the trim down with its top edge over the glass panel until the clip snap in on each side of the trim.
3. Push the middle of the trim down to ensure it is straight and firm against the glass panel.

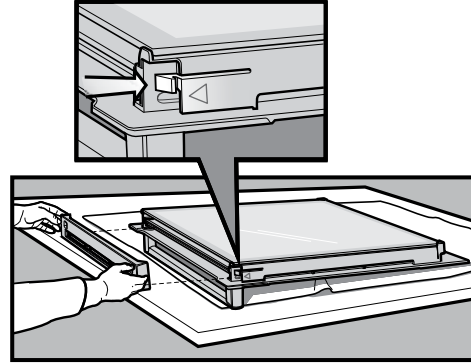

## Fitting the oven door

1. Take hold of the oven door with a hand on each side and with the door at an angle of 30°, position the recesses at the bottom of the door onto the hinge arms of the oven. Let the door slide down the hinge arms as far as it will go.

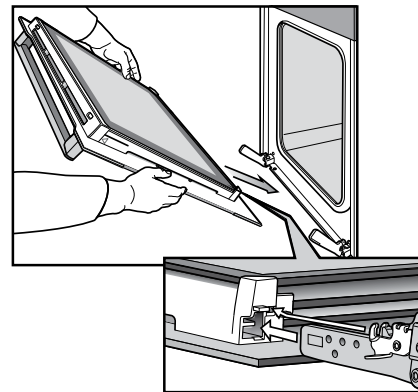

2. Open the door fully to access the hinges.
3. Rotate the 'stirrups' (see the diagram below) until they lock into the hook. The oven door may now be closed.

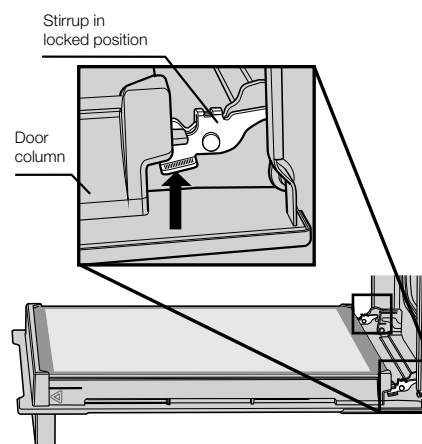

# TIPS AND TROUBLESHOOTING



## IMPORTANT

### Cooling/ventilation fan

**This appliance is fitted with a cooling fan. This prevents your kitchen cabinet from overheating and reduces the condensation inside the oven. It will operate whenever you are using the oven and blow warm air across the top of the oven door.**

*NOTE: If the oven is still hot from cooking, the cooling fan will keep running to cool the oven down and will switch off by itself once cool.*



## CAUTION

### Using the oven

- Always cook with the oven door closed.
- Stand clear when opening the drop down oven door. Do not allow it to fall open. Always support the door using the door handle until it is fully open.
- Do not lean on an open oven door, or place heavy items on it. This could damage the appliance. Take care in the region of the hinges.



## IMPORTANT

### Condensation and steam

This appliance is supplied with an exclusive system which produces a natural circulation of air and the constant recycling of steam.

This steam makes it possible to cook in a steamy environment ensuring that dishes are soft inside and crusty on the outside. This process also reduces cooking time and energy consumption. During cooking steam may be produced and released when the door is opened. This is absolutely normal.

When food is heated it produces steam in the same way a boiling kettle does. When steam comes into contact with the oven door glass it will condense and produce water droplets. To reduce condensation, ensure that the oven is well heated before placing food in the oven cavity.

Oven pre-heating is necessary before any cooking.

It is recommended that condensation is wiped away after each use of the oven.

### The effects of dishes on cooking results

Dishes and tins vary in their thickness, heat conductivity, colour etc. which affects the way they transfer heat to the food inside them.

- Aluminium, earthenware, oven glassware and bright shiny utensils reduce cooking and base browning.
- Enamelled cast iron, anodized aluminium, aluminium with non-stick interior and coloured exterior and dark, heavy utensils increase cooking and base browning.
- To increase base browning simply lower the shelf position. To increase top browning, raise the shelf position.
- Always place dishes centrally on the shelf to ensure even browning.
- Single level cooking gives best results in conventional modes that do not use the oven fan. If cooking on more than one level, use the fan cooking function.

### Faults

If there is a problem with the oven or grill, please check the points listed below before calling for service. It may be possible to avoid a call by fixing the problem yourself - and so continue cooking.

### Data plate

When you need information, service or spare parts please be prepared to tell us the:

Model number: \_\_\_\_\_

Serial number: \_\_\_\_\_

These are shown on the data plate. The data plate is visible when the oven or grill door is open.

### Customer Care Centre

If you need more information, please contact the Customer Care Centre:

Australia: 1300 363 640, 8am – 5pm EST Mon – Fri.

New Zealand: +649 573 2384, 8am – 5pm EST Mon – Fri.

If you have a warranty or spare parts enquiry, you should call the number listed on the back page.

# TROUBLESHOOTING

*NOTE: We may charge for service even in the warranty period if your problem is due to the causes listed below.*

<b>problem</b>	<b>possible cause</b>
Oven or grill not working	<ul style="list-style-type: none"> <li>• Time of day is not set.</li> <li>• Power is not turned on.</li> <li>• Controls are incorrectly set.</li> <li>• Oven is in 'Demo' mode, refer to Additional Functionality.</li> <li>• Household fuse has blown or power supply is off. (If the household fuse continues to blow, call the Service Centre).</li> <li>• Child-proof oven lock is activated. 'LOCKED' is displayed when control is touched. (Refer to operating instructions).</li> </ul>
Oven light not working	<ul style="list-style-type: none"> <li>• Light may be turned off at control panel.</li> <li>• Lamp blown or loose socket.</li> <li>• Household fuse has blown. (If the household fuse continues to blow, call the Service Centre).</li> </ul>
Oven not heating enough	<ul style="list-style-type: none"> <li>• Foil trays on bottom of oven.</li> <li>• Timer is in 'AUTO' mode. (Refer to operating instructions).</li> <li>• Household fuse has blown or power supply is off. (If the household fuse continues to blow, call the Service Centre).</li> </ul>
Clock flashing on display	<ul style="list-style-type: none"> <li>• Reset time of day and any cooking functions you were using.</li> </ul>
Unit smoking when first used	<ul style="list-style-type: none"> <li>• Protective oils being removed.</li> </ul>
Condensation build up	<ul style="list-style-type: none"> <li>• Reduce the amount of water used in cooking. (Sometimes condensation is normal).</li> </ul>
Door cannot be replaced after removal	<ul style="list-style-type: none"> <li>• Stirrup not engaged properly.</li> </ul>
Functions and temperature appear on display but oven does not work	<ul style="list-style-type: none"> <li>• Oven is in 'Demo' mode, refer to Additional Functionality.</li> </ul>
When the door is open the fan stops (underbench only)	<ul style="list-style-type: none"> <li>• This is a function of the power board to help reduce the blast of air when opening the door.</li> </ul>
When a non fan mode is selected the fan starts	<ul style="list-style-type: none"> <li>• Most oven modes have a fast heat up function that uses the fan, fan element and top (boost) elements. Auto fast heat up can be overridden by selecting a temperature of 120°C or less, allowing the function to start, then increasing the temperature to the desired level.</li> </ul>
The light stays on when the door is closed	<ul style="list-style-type: none"> <li>• An oven function has been selected.</li> <li>• The light has been turned on at the control panel.</li> </ul>
The light does not turn *ON* when the door is opened	<ul style="list-style-type: none"> <li>• Oven light may need replacing.</li> </ul>
Error message "REMOVE FOOD PROBE" after connecting Food Probe to appliance	<ul style="list-style-type: none"> <li>• The cooking function selected is not compatible with the food probe. Refer Food Probe instructions page.</li> </ul>
Food Probe temperature setting not displayed	<ul style="list-style-type: none"> <li>• Ensure Food Probe plug is fully inserted into the socket on the front panel.</li> <li>• Incorrect Food Probe used. Only use the Food Probe recommended for this appliance.</li> <li>• Ensure food is fully defrosted</li> </ul>
When using the Food Probe, centre of the food is undercooked	<ul style="list-style-type: none"> <li>• Ensure the Food Probe is inserted at least 75% into the food.</li> <li>• Ensure that food has been adequately rested after cooking.</li> </ul>
Shelf or telescopic runner slides out when door is opened	<ul style="list-style-type: none"> <li>• Oven cavity is not level, you can perform a check using a level to verify this (refer to installation section). If not level refer to installer.</li> </ul>
Door locked (switching off Pyro function quickly)	<ul style="list-style-type: none"> <li>• Go back into Pyro mode and switch off Pyro function after few seconds for the lock to open completely.</li> </ul>
Lime scale residue on base of oven	<ul style="list-style-type: none"> <li>• Follow the procedure for cleaning the cavity well. There may be some minor residual marks after cleaning.</li> </ul>
Oven seal loose	<ul style="list-style-type: none"> <li>• The oven seal of non pyrolytic models is only attached at each corner. It may seem like a loose fit, but when the oven is closed it will function correctly.</li> </ul>

# INSTALLATION OF THE APPLIANCE

## WARNING

**The appliance must not be installed behind a decorative door in order to avoid overheating.**

**To avoid any potential hazard, you must follow our instructions when you install your appliance. Failure to install the appliance correctly could invalidate any warranty or liability claims and lead to prosecution.**

## Use an authorised person

As stated in the local municipal building codes and other relevant statutory regulations:

- Wiring connections must be in accordance with AS/NZS 3000 Wiring Rules and any particular conditions of the local authority.
- Refer to data plate for rating information. The data plate is positioned behind the bottom of the oven door.
- For appliances with open cooking surfaces, a disconnect functional switch should be provided near the appliance in an accessible position. Refer to AS/NZS 3000 clause 4.7.1
- Wiring should be protected against mechanical failure. Refer to AS/NZS3000 clauses 3.3.2.6, 3.9, 3.10
- A means of disconnection with a contact separation of at least 3mm must be supplied in the fixed wiring.
- This appliance must be connected with cable of 75°C rating minimum.
- This product has passed the insulation resistance test after manufacture. If the resistance reading is low at installation, it is probably caused by moisture from the atmosphere being absorbed by the elements after the appliance has been produced. (pass at 0.01MΩ AS/NZS 3000 Wiring Rules Clause 8.3.6.2).

## WARNING

**This appliance must be properly earthed.**

- Do not lift the appliance by the door handles.
- Prepare the cupboard opening to match your appliance measurements. (See diagrams)
- Slide appliance into the cupboard, ensuring that the supply cable (where fitted) does not kink.
- To prevent tipping, use the screws supplied to secure your appliance into the cupboard by fastening through the 4 holes to the front panel.
- Where the appliance is built into a cabinet, the cabinet must be capable of withstanding 70°C. Installation into low temperature tolerant cabinetry (e.g. Vinyl coated) may result in deterioration of the low temperature coating by discolouring or bubbling.
- If the appliance is to be installed adjacent to vinyl wrapped surfaces, use an installation kit available from the vinyl-wrap supplier.

- Electrolux Home Products cannot accept responsibility for damage caused by installation into low temperature tolerant cabinets.
- After installation, test and ensure that the appliance operates correctly before handing it over to the customer.

*NOTE: If a powerpoint is fitted it must be accessible with the appliance installed, as the plug must be accessible after installation.*

## Cabinet construction for your appliance

For the best integration within a kitchen, install this appliance in a standard 600mm wide cupboard that gives a flush fit (Figure A) with the surrounding cupboard fronts. Non-pyrolytic appliances can also be installed using a proud fit (Figure B).

## IMPORTANT

**For all Pyrolytic clean models, the oven must be installed as a flush fit (Figure A) to the surrounding cupboards and the “infill panel” MUST not exceed 100mm in length. This ensures a 16mm gap is maintained between the cabinet and side of the appliance to prevent the cupboard overheating.**

Figure A – Flush Fit

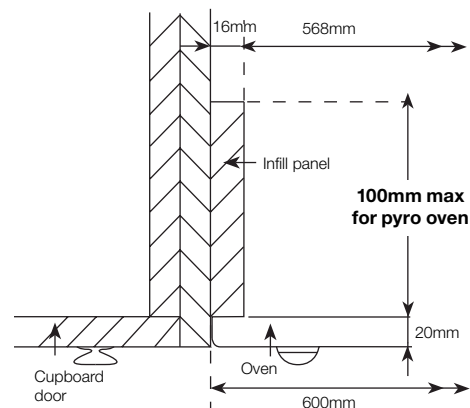
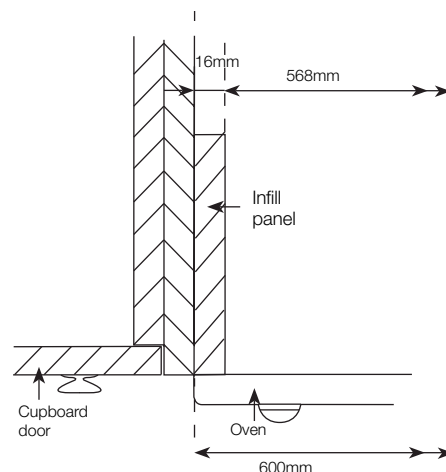

Figure B – Proud Fit



*NOTE: Your appliance must be mounted on a flat horizontal surface for the full width and depth of the product*

# INSTALLATION OF THE APPLIANCE (CONTINUED)

## Levelling oven

Place a level in the oven as below making sure the level sits on the front and rear forms. The level needs to be correct to prevent slides from moving in or out with gravity.

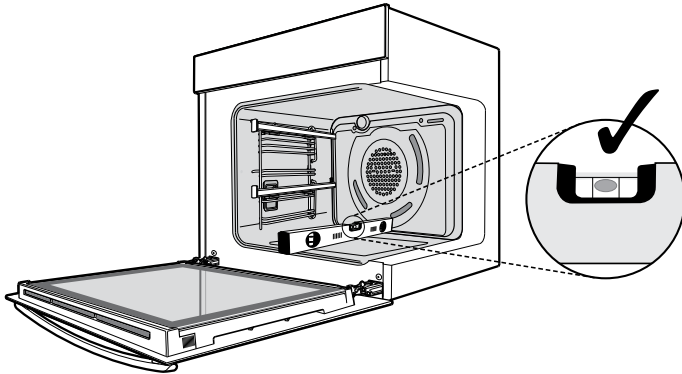

## Underbench oven

Your underbench oven looks best when the control panel is directly under the benchtop. An upper infill panel may be added if the cooktop placed above the benchtop is too deep. Refer to cooktop installation instructions for required clearance between cooktop and oven.

### **i** IMPORTANT!

**Note: Dimension 'D'\***

**A requirement for all EVEPxxxx pyrolytic clean ovens and all Duo ovens – for proper ventilation there MUST be a gap at the bottom rear of the cabinet. This can be a full width opening 20mm deep. Refer to dimension “D” in relevant diagram.**

*Power point connection for the EVEP618 must be accessible with the appliance fully installed. If the supply cord is damaged it must be replaced by the manufacturer, its service agent or similarly qualified persons in order to avoid a hazard.*

## Cut-out dimensions

type of fit	A (width)	B (height)	C (depth)
Flush fit (mm)	600	600	581 min.
Proud fit (mm)	568	590	560 min.

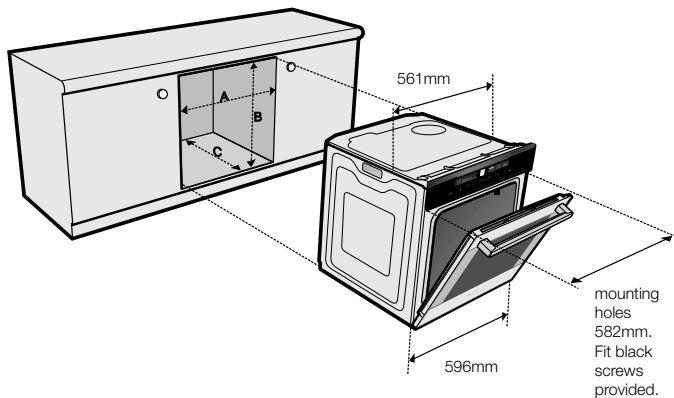

## Double oven Cut-out dimensions

type of fit	A (width)	B (height)	C (depth)
Flush fit (mm)	600	1086	581 min.
Proud fit (mm)	568	1078	560 min.

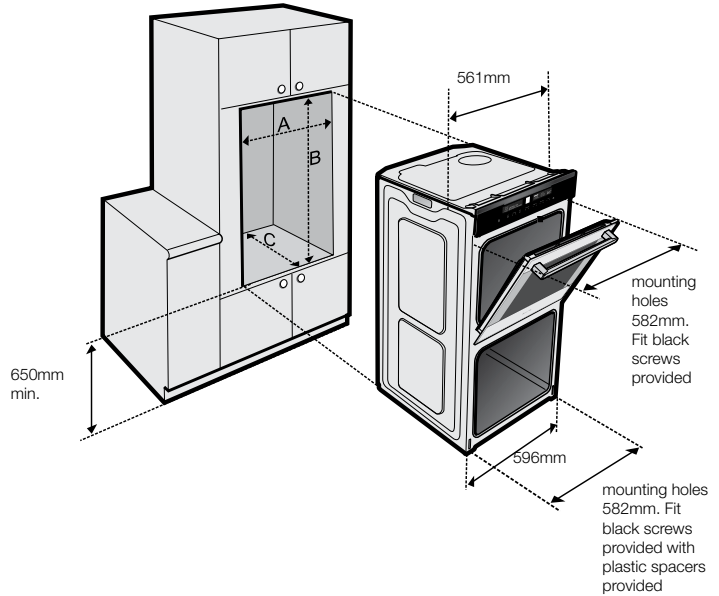

## Pyrolytic underbench Cut-out dimensions

type of fit	A (width)	B (height)	C (depth)	D*
Flush fit (mm)	600	600	581 min.	20

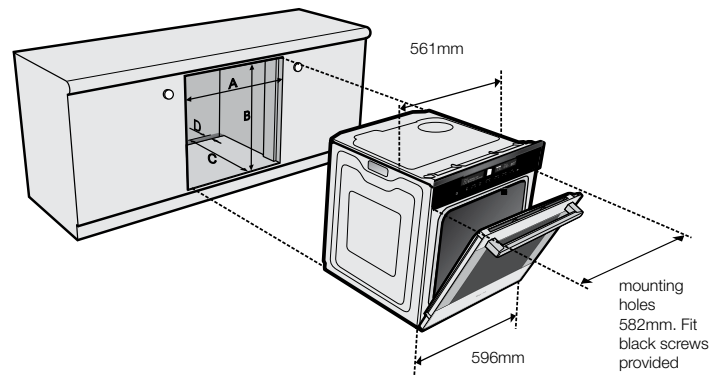

## Duo oven Cut-out dimensions

type of fit	A (width)	B (height)	C (depth)	D*
Flush fit (mm)	600	893	581 min.	20

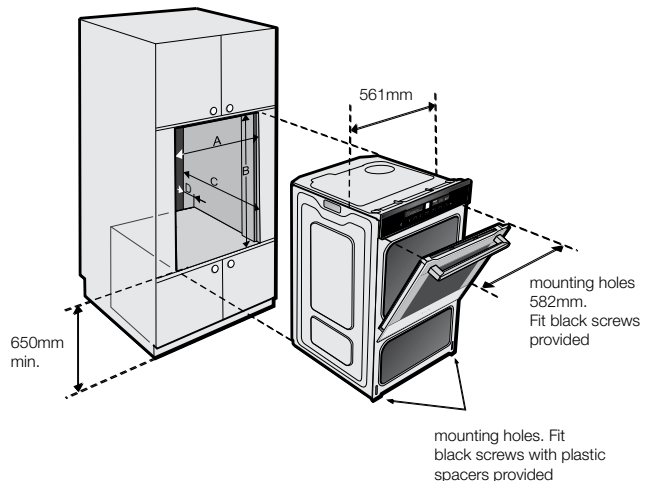

# TECHNICAL SPECIFICATIONS

model	product dimensions (h x w x d) mm	electrical connection	min. fuse rating	max. power rating	max. current rating
EVE614	597 x 596 x 568	230-240V/50Hz	16A	3.1kW	12.9A
EVE616	597 x 596 x 568	230-240V/50Hz	16A	3.1kW	12.9A
EVEP614	597 x 596 x 572	230-240V/50Hz	16A	3.1kW	12.9A
EVEP616	597 x 596 x 572	230-240V/50Hz	16A	3.1kW	12.9A
EVEP618	597 x 596 x 572	230-240V/50Hz	16A	3.1kW	12.9A
EVE626	890 x 596 x 568	230-240V/50Hz	25A	5.3kW	22.1A
EVEP626	890 x 596 x 572	230-240V/50Hz	25A	5.3kW	22.1A
EVE636	1083 x 596 x 568	230-240V/50Hz	32A	6.2kW	25.8A

## Hard wiring details

1. Remove terminal cover plate from rear panel of appliance.
2. Fit wires through hole in cover plate and make connections to terminals.
3. Engage wires into plastic clip. Secure plastic clip with two long silver screws (supplied in separate bag).
4. Replace cover plate onto rear panel.

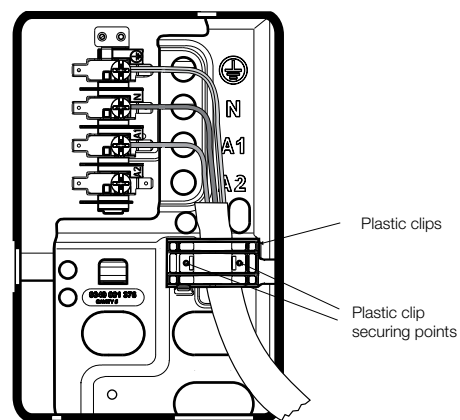









FOR SALES IN AUSTRALIA AND NEW ZEALAND  
 APPLIANCE: ELECTROLUX BUILT-IN OVENS, COOKTOPS AND  
 FREESTANDING COOKER

**This document sets out the terms and conditions of the product warranties for Electrolux Appliances. It is an important document. Please keep it with your proof of purchase documents in a safe place for future reference should there be a manufacturing defect in your Appliance. This warranty is in addition to other rights you may have under the Australian Consumer Law.**

**1. In this warranty:**

- (a) 'ACL' or 'Australian Consumer Law' means Schedule 2 to the Competition and Consumer Act 2010;
- (b) 'Appliance' means any Electrolux product purchased by you and accompanied by this document;
- (c) 'ASC' means Electrolux's authorised serviced centres;
- (d) 'Electrolux' is the brand controlled by Electrolux Home Products Pty Ltd of 163 O'Riordan Street, Mascot NSW 2020, ABN 51 004 762 341 in respect of Appliances purchased in Australia and Electrolux (NZ) Limited (collectively "Electrolux") of 3-5 Niall Burgess Road, Mount Wellington, in respect of Appliances purchased in New Zealand;
- (e) 'Warranty Period' means the period specified in clause 3 of this warranty;
- (f) 'you' means the purchaser of the Appliance not having purchased the Appliance for re-sale, and 'your' has a corresponding meaning.

**2. Application:** This warranty only applies to new Appliances, purchased and used in Australia or New Zealand and is in addition to (and does not exclude, restrict, or modify in any way) other rights and remedies under a law to which the Appliances or services relate, including any non-excludable statutory guarantees in Australia and New Zealand.

**3. Warranty Period:** Subject to these terms and conditions, this warranty continues in Australia for a period of 24 months and in New Zealand for a period of 24 months, following the date of original purchase of the Appliance.

**4. Repair or replace warranty:** During the Warranty Period, Electrolux or its ASC will, at no extra charge if your Appliance is readily accessible for service, without special equipment and subject to these terms and conditions, repair or replace any parts which it considers to be defective. Electrolux may, in its absolute discretion, choose whether the remedy offered for a valid warranty claim is repair or replacement. Electrolux or its ASC may use refurbished parts to repair your Appliance. You agree that any replaced Appliances or parts become the property of Electrolux.

**5. Travel and transportation costs:** Subject to clause 7, Electrolux will bear the reasonable cost of transportation, travel and delivery of the Appliance to and from Electrolux or its ASC. Travel and transportation will be arranged by Electrolux as part of any valid warranty claim.

**6. Proof of purchase** is required before you can make a claim under this warranty.

**7. Exclusions:** You may not make a claim under this warranty unless the defect claimed is due to faulty or defective parts or workmanship. This warranty does not cover:

- (a) light globes, batteries, filters or similar perishable parts;
- (b) parts and Appliances not supplied by Electrolux;
- (c) cosmetic damage which does not affect the operation of the Appliance;

- (d) damage to the Appliance caused by:
  - (i) negligence or accident;
  - (ii) misuse or abuse, including failure to properly maintain or service;
  - (iii) improper, negligent or faulty servicing or repair works done by anyone other than an Electrolux authorised repairer or ASC;
  - (iv) normal wear and tear;
  - (v) power surges, electrical storm damage or incorrect power supply;
  - (vi) incomplete or improper installation;
  - (vii) incorrect, improper or inappropriate operation;
  - (viii) insect or vermin infestation;
  - (ix) failure to comply with any additional instructions supplied with the Appliance;

In addition, Electrolux is not liable under this warranty if:

- (a) the Appliance has been, or Electrolux reasonably believes that the Appliance has been, used for purposes other than those for which the Appliance was intended, including where the Appliance has been used for any non-domestic purpose;
- (b) the Appliance is modified without authority from Electrolux in writing;
- (c) the Appliance's serial number or warranty seal has been removed or defaced

**8. How to claim under this warranty:** To enquire about claiming under this warranty, please follow these steps:

- (a) carefully check the operating instructions, user manual and the terms of this warranty;
- (b) have the model and serial number of the Appliance available;
- (c) have the proof of purchase (e.g. an invoice) available;
- (d) telephone the numbers shown below.

**9. Australia:** For Appliances and services provided by Electrolux in Australia: Electrolux goods come with guarantees that cannot be excluded under the Australian Consumer Law. You are entitled to a replacement or refund for a major failure and for compensation for any other reasonably foreseeable loss or damage. You are also entitled to have the Appliance repaired or replaced if the Appliance fails to be of acceptable quality and the failure does not amount to a major failure. 'Acceptable quality' and 'major failure' have the same meaning as referred to in the ACL.

**10. New Zealand:** For Appliances and services provided by Electrolux in New Zealand, the Appliances come with a guarantee by Electrolux pursuant to the provisions of the Consumer Guarantees Act, the Sale of Goods Act and the Fair Trading Act. Where the Appliance was purchased in New Zealand for commercial purposes the Consumer Guarantee Act does not apply.

**11. Confidentiality:** You accept that if you make a warranty claim, Electrolux and its agents including ASC may exchange information in relation to you to enable Electrolux to meet its obligations under this warranty.

**Important Notice**

Before calling for service, please ensure that the steps listed in clause 8 above have been followed.

<p><b>FOR SERVICE</b>                      or to find the address of your nearest authorised service centre in Australia  <b>PLEASE CALL 13 13 49</b>                      For the cost of a local call (Australia only)</p>	<p><b>AUSTRALIA</b>                      ELECTROLUX HOME PRODUCTS                      163 O'Riordan Street, Mascot NSW 2020                      electrolux.com.au</p>	<p><b>FOR SPARE PARTS</b>                      or to find the address of your nearest spare parts centre in Australia  <b>PLEASE 13 13 50</b>                      For the cost of a local call (Australia only)</p>
<p><b>FOR SERVICE</b>                      or to find the address of your nearest authorised service centre in New Zealand  <b>PLEASE CALL 0800 10 66 10</b>                      (New Zealand only)</p>	<p><b>NEW ZEALAND</b>                      ELECTROLUX (NZ) Limited                      3-5 Niall Burgess Road, Mount Wellington                      electrolux.co.nz</p>	<p><b>FOR SPARE PARTS</b>                      or to find the address of your nearest spare parts centre in New Zealand  <b>PLEASE 0800 10 66 20</b>                      (New Zealand only)</p>

**Electrolux Home Products Australia**

telephone: 1300 363 640  
fax: 1800 350 067  
email: [customercare@electrolux.com.au](mailto:customercare@electrolux.com.au)  
web: [electrolux.com.au](http://electrolux.com.au)

**shop.electrolux.com.au**



**Electrolux Home Products New Zealand**

telephone: 0800 436 245  
fax: 0800 225 088  
email: [customercare@electrolux.co.nz](mailto:customercare@electrolux.co.nz)  
web: [electrolux.co.nz](http://electrolux.co.nz)



To add a touch of professional inspiration to your home, visit [electrolux.com.au](http://electrolux.com.au) or [electrolux.co.nz](http://electrolux.co.nz)

[electrolux.com.au](http://electrolux.com.au)



or [electrolux.co.nz](http://electrolux.co.nz)



ANC A13110601  
Rev A ECN 99373

© 2018 Electrolux Home Products Pty Ltd.  
ABN 51 004 762 341

EMAN\_Ovens\_Aug18