

**FRENCH DOOR  
HANDLE INSTALLATION**

WHE5200, WHE5260, WHE5600

## GENERAL WARNINGS

Please read the user manual carefully and store in a handy place for later reference. Pass the user manual on to possible new owners of the appliance.

Read the following carefully to avoid damage or injury.

*NOTE: You must read these warnings carefully before installing or using the accessory. If you need assistance, contact your Customer Care Department. The manufacturer will not accept liability, should these instructions or any other safety instructions incorporated in this book be ignored.*



### ENVIRONMENT

Remove and discard any packaging material before using this accessory. Most of the packaging materials are recyclable. Please dispose of those materials through your local recycling depot or by placing them in the appropriate collection containers.



### WARNING

Risk of suffocation, injury or permanent disability.

- This accessory is not intended for use by persons (including children) with reduced physical, sensory or mental capabilities, or lack of experience and knowledge, unless they have been given supervision or instructions concerning the use of the appliance by a person responsible for their safety.
- This accessory may contain small parts that are a choking hazard. Not suitable for children under 3 years of age.



### CAUTION

It is important to use your appliance safely. Check these safety points before using your appliance.

- Do not use or place the accessory near the edge of the table or counter, near hot gas, stove, electric burner or heated oven.
- This accessory is for indoor use only.
- This accessory is intended for domestic use only. Electrolux will not accept any liability for possible damage caused by improper or incorrect use.
- When cleaning, use only a soft cloth with an unscented mild soap and lukewarm water.
- Never use hot water, solvents, commercial kitchen cleaners, aerosol cleaners, metal polishes, caustic or abrasive cleaners, or scourers to clean the accessory, as they may damage it. Many commercially available cleaning products and detergents contain solvents that will damage your accessory.

## KIT CONTENTS

Read and follow instructions carefully when installing the handles on this appliance, you may not be eligible to make a claim under warranty for damage caused by incorrect installation techniques. Please refer to warranty card in the product user manual for further warranty information.

### 3 x Handle assemblies

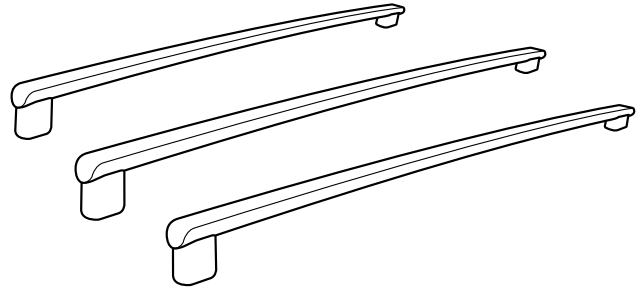

### 1 x Installation instructions



# INSTALLATION

## Installing door handles

### Step 1.

Fit bottom door handle first.

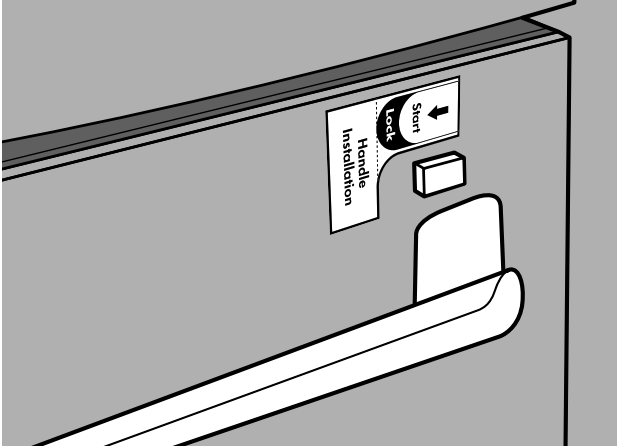

### Step 2.

Position handle over handle mounts and align with template on the door.

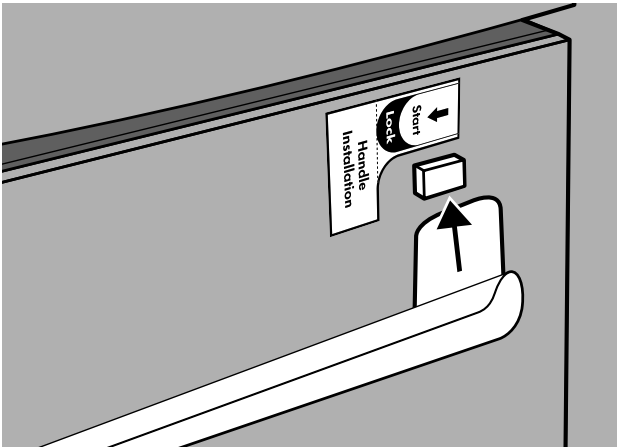

### Step 3.

Pull handle down and across until it locks into position and aligns with template on the door.

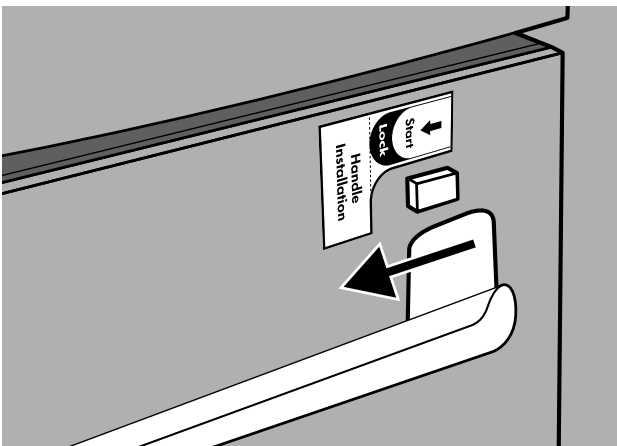

### Step 4.

Position top door handles (LH & RH) over handle mounts and align with template on the door.

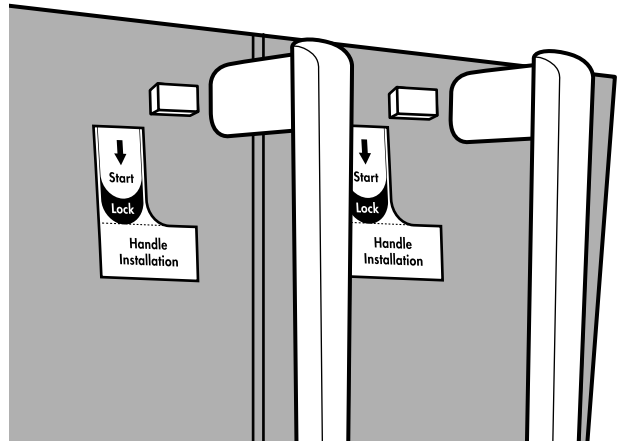

### Step 5.

Pull handle down until it locks into position and aligns with template on the door.

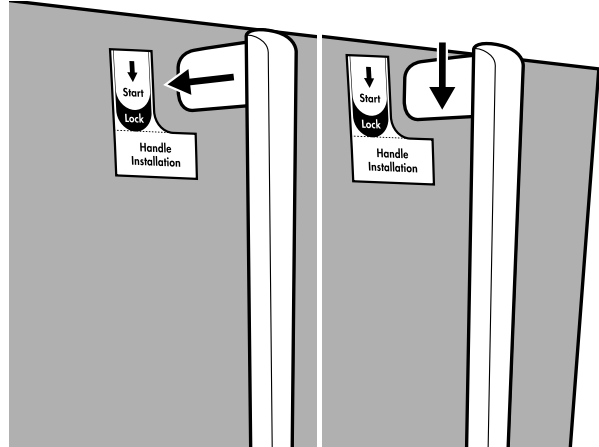

### Step 6.

Remove templates after handle fitment.

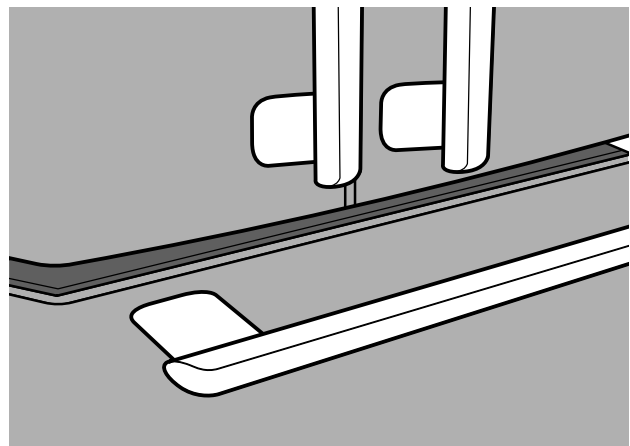

For more information on all Westinghouse appliances, or for dimension and installation information, call into your retailer, phone or email our customer care team or visit our website:

### AUSTRALIA

phone: 1300 363 640  
 fax: 1800 350 067  
 email: [customercare@electrolux.com.au](mailto:customercare@electrolux.com.au)  
 web: [westinghouse.com.au](http://westinghouse.com.au)

### NEW ZEALAND

phone: 0800 436 245  
 fax: 0800 225 088  
 email: [customercare@electrolux.co.nz](mailto:customercare@electrolux.co.nz)  
 web: [westinghouse.co.nz](http://westinghouse.co.nz)

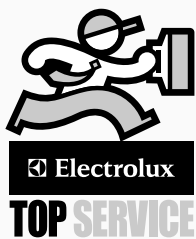

### TOP SERVICE

Top Service encompasses the after sales service provided by The Electrolux Group to consumers including delivery, home service and spare parts.

#### Important Notice

<p><b>FOR SERVICE</b>                      or to find the address of your nearest state service centre in Australia  <b>PLEASE CALL 13 13 49</b>                      For the cost of a local call (Australia only)</p>	<p><b>SERVICE AUSTRALIA</b>   <b>Electrolux</b>                      ELECTROLUX HOME PRODUCTS  <a href="http://electrolux.com.au">electrolux.com.au</a></p>	<p><b>FOR SPARE PARTS</b>                      or to find the address of your nearest state spare parts centre in Australia  <b>PLEASE CALL 13 13 50</b>                      For the cost of a local call (Australia only)</p>
<p><b>FOR SERVICE</b>                      or to find the address of your nearest authorised service centre in New Zealand  <b>FREE CALL 0800 10 66 10</b>                      (New Zealand only)</p>	<p><b>SERVICE NEW ZEALAND</b>   <b>Electrolux</b>                      ELECTROLUX (NZ) Limited  <a href="http://electrolux.co.nz">electrolux.co.nz</a></p>	<p><b>FOR SPARE PARTS</b>                      or to find the address of your nearest state spare parts centre in New Zealand  <b>FREE CALL 0800 10 66 20</b>                      (New Zealand only)</p>

 and WESTINGHOUSE are trademarks of Westinghouse Electric Corporation. Used under license. All Rights Reserved.