

Quick Start Guide

WVEP916 oven series

Dear Customer,

Thank you for purchasing a Westinghouse oven. You have chosen a product that comes from a history of durable and reliable products loved by many families. We look to help you make the most of your time at home, so you can spend your time doing what you really love, with the ones you love.

Welcome to Westinghouse.

Ready



This is a Quick Start Guide. Please refer to user manual online for detailed information and installation

To access your detailed user manual online, simply scan the QR code on your smart phone.

For more detailed information and installation guide refer to user manuals at westinghouse.com.au/manuals

Before you start, please make sure:

- Your oven has been correctly installed by a qualified person.
- Your oven has power and is switched on.
- You've removed all relevant packaging.

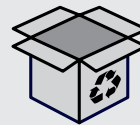

Most of the packaging materials can be recycled. Please dispose of them at your local recycling centre or in your own recycling bin.

Set...

Get to know your oven control panel:

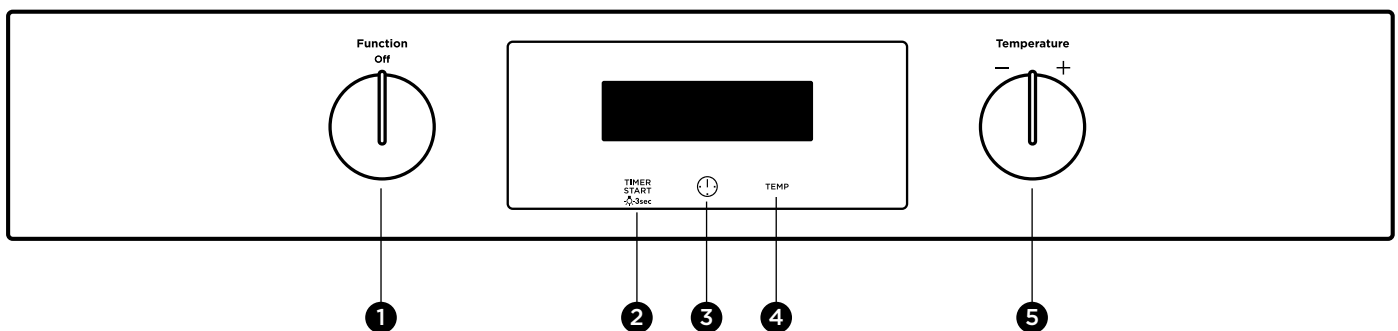

- 1 Function selector
- 2 Touch to start timer mode. Hold to turn oven light on/off
- 3 Touch to toggle through timer modes
- 4 Touch to toggle through cooking time and oven set temperature
- 5 Temperature selector

Set...

Installing the oven accessories

1. Install telescopic slides (where supplied) to the side racks. Refer to installation guide supplied with oven slides.

2. Insert side racks

There is a left hand and right hand version (see image).

1. Insert the rear peg into the rear access hole, ensuring that the peg is fully inserted.
2. Then locate the front peg into the front access hole and push in firmly.

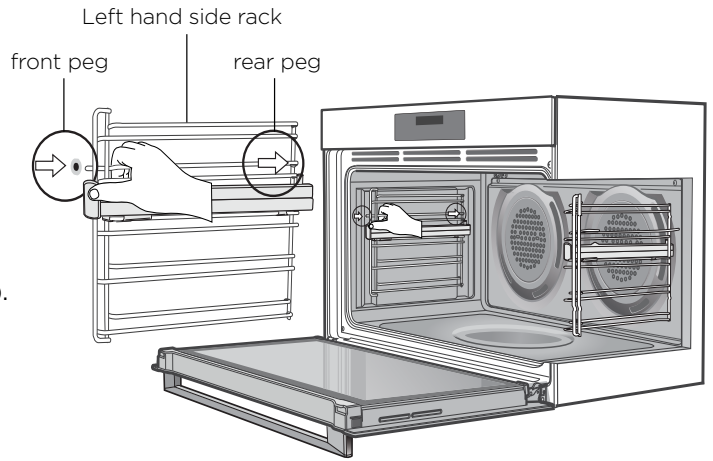

3. To fit a shelf or tray to side racks:

1. Locate the rear edge of the shelf in between guide rails of the side rack. Ensure the same rail positions on both sides of the oven are being engaged.
2. With the front edge raised, slide the shelf into the oven.
3. Once the detents have passed the front edge of the side rack, the shelf can be pushed completely in.

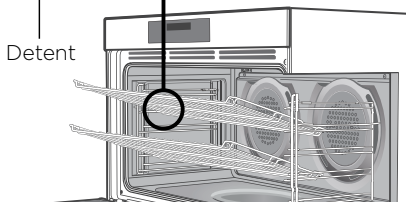
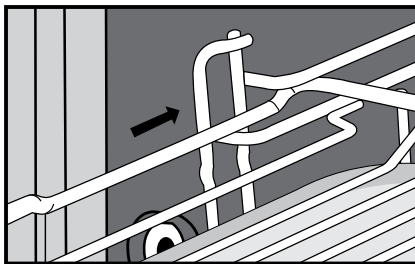

4. Fit shelf/tray (where supplied) to telescopic slides

1. Push the shelf or tray along the top of the slide until it hits the back post.

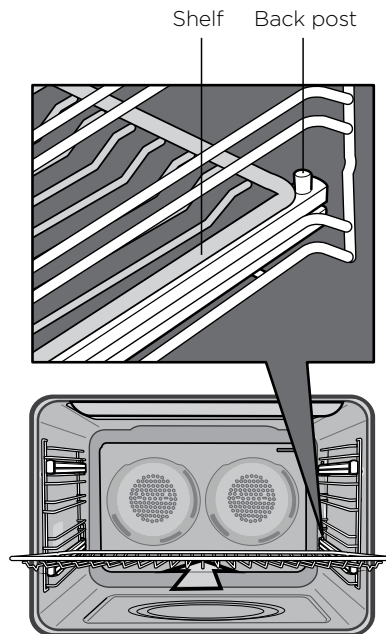

2. Drop the front of the shelf or tray onto the slide ensuring it sits behind the front post of the slide.

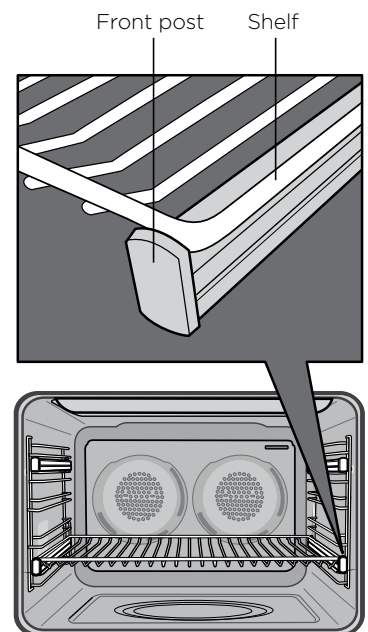

3. When fully inserted the shelf/tray should not interfere with the closed oven door.

Set the time

You must set the time before you can operate your appliance.

1. After the appliance has been electrically connected, the ⌚ clock icon will be displayed. Along with the clock icon, the "12" will be flashing.
2. Toggle the temp selector $-$ or $+$, then touch ⌚ when the correct hour is displayed.
3. The minutes will then flash and can be set in the same manner.
4. 5 seconds after the last change, the clock display will stop flashing, confirming that the time has been set.

NOTE: The clock has a 24 hour display.

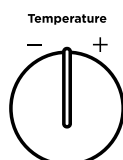
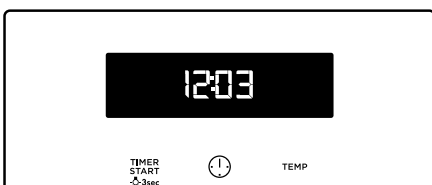

Condition the oven (to burn off any residue)

New appliances can have oil or residue left from manufacturing. You will need to heat your oven for 2 hours before using it for the first time.

1. Turn the function selector dial to FAN FORCED.
2. Using the temperature selector, set the oven at 180°C for approximately 2 hours. Please ensure that the room is well ventilated during this process.

Function
Off

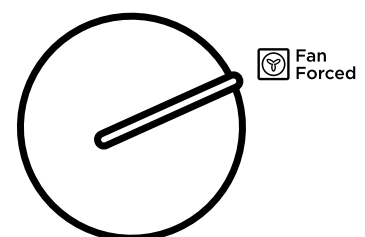

Go!

You're ready to use your new Westinghouse appliance. A few tips from us:

Remember to pre-heat each time.

For best cooking results pre-heat the oven. Pre-heating allows the oven to reach the required temperature quickly and efficiently as well as cook food at the correct temperature for the entire cook time. Recommended pre-heat time is 30 mins for baking and 3 minutes for grilling.

Choose the right program for the best result:

FAN
FORCED



This setting is best used when cooking on multiple shelves at once or reheating complete meals for your family.

BAKE



The "Bake" function is ideal for a single tray of biscuits, scones, muffins, cakes, slices, casseroles, baked puddings, roasts and delicate egg dishes.

GRILL



When it comes to cooking tender cuts of meat, steak, chops, sausages, fish, cheese toasties and other quick cooking foods the grill setting will get you the best results. By preheating your grill for 3 minutes this will help in sealing in the natural juices for a better flavour. Grill with the oven door closed.

AIR FRY



Air Fry uses superheated air that is quickly and evenly circulated around the oven to deliver perfect healthy crunch with little or no oil.

PIZZA



The "Pizza" function is ideal for food that require cooking and browning on the base. It is great for foods such as pizzas, quiches, meat pies and fruit pies. Simply place the food in the middle of the oven and set the desired temperature.

Refer to your full user manual for more details on oven functions.

Set your temperature

Toggle the temperature selector left (—) or right (+) as required to set the desired cooking temperature.

NOTE: the temperature can be adjusted at any time throughout the cooking time.

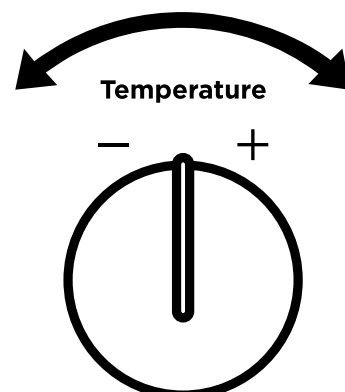

Quick Start Guide

WVEP916 oven series

Easily register your product with your smartphone for quick access to all services and downloads

Step 1

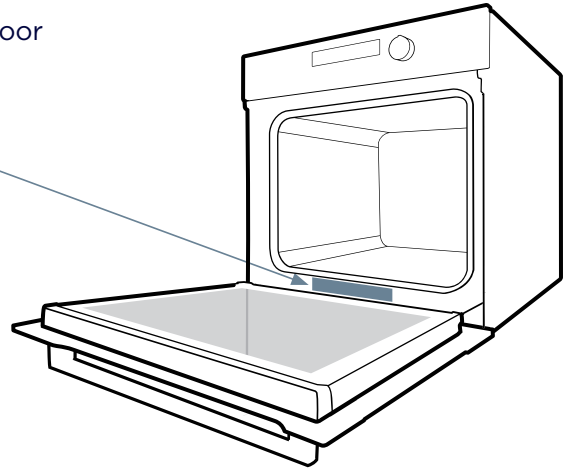
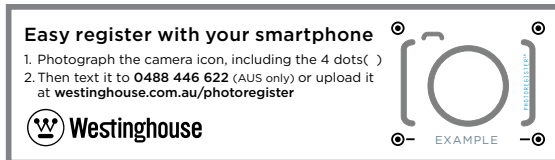
 Locate the label on the inside of your product door

Step 2

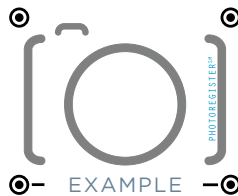
 Photograph the camera icon, including the 4 dots ()

Step 3

 Text image to **0488 446 622** (AUS only) or enter code at westinghouse.com.au/photoregister

Need more help?

To access your detailed user manual online, simply scan the QR code on your smart phone.



Customer Care Centre

Contact us if you need more help

Electrolux Home Products Australia

telephone: 13 13 49
email: customercare@electrolux.com.au
web: electrolux.com.au

Electrolux Home Products New Zealand

telephone: 0800 436 245
email: customercare@electrolux.co.nz
web: electrolux.co.nz