

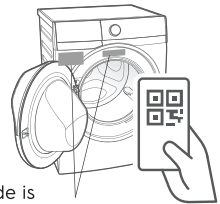

Enjoy peace of mind. Register your appliance today.

Stay updated on better living services,
safety notices and shop for accessories.

- 1. Open the camera app on your smartphone and point at the QR code to scan.**



Product Registration QR code is located on the front of your appliance or inside the door rim.

- 2. Tap the notification or link to open the registration form.**

- 3. Complete your details and enjoy peace of mind.**



Electrolux

IMPORTANT INFORMATION THAT MAY IMPACT YOUR MANUFACTURER'S WARRANTY

Adherence to the directions for use in this manual is extremely important for health and safety. Failure to strictly adhere to the requirements in this manual may result in personal injury, property damage and affect your ability to make a claim under the Electrolux manufacturer's warranty provided with your product. Products must be used, installed and operated in accordance with this manual. You may not be able to claim on the Electrolux manufacturer's warranty in the event that your product fault is due to failure to adhere to this manual.

WE'RE THINKING OF YOU

Thank you for purchasing an Electrolux appliance. You've chosen a product that brings with it decades of professional experience and innovation. Ingenious and stylish, it has been designed with you in mind. So whenever you use it, you can be safe in the knowledge that you'll get great results every time. Welcome to Electrolux.

Visit our website to:



Get usage advice, brochures, troubleshooter, service information, buy accessories & spare parts, online product registration : **www.electrolux.com**

CUSTOMER CARE AND SERVICE

We recommend the use of original spare parts. When contacting Service, ensure that you have the following data available. The information can be found on the rating plate. Model, PNC, Serial Number.



 Warning / Caution-Safety information.

 General information and tips

 Environmental information.

Subject to change without notice.

CONTENTS

1.  SAFETY INFORMATION..... 4	8. CARE AND CLEANING..... 31
1.1 Conditions Of Use 4	8.1 External Cleaning..... 31
1.2 Child Safety 5	8.2 Descaling 31
1.3 General Safety 5	8.3 After Each Wash..... 31
1.4 Installation 6	8.4 Maintenance Wash..... 31
1.5 Use 6	8.5 Cleaning The Detergent Dispenser And The Autodose Tanks 31
2. PRODUCT DESCRIPTION 7	8.6 Cleaning The Pump..... 33
2.1 Parts 7	8.7 Cleaning The Water Inlet Filter 35
2.2 Accessories 8	8.8 Frost Precautions 37
2.3 Load Sensor..... 9	9. TROUBLESHOOTING..... 38
2.4 The Autodose Technology (Autodosing)..... 10	9.1 Possible Failures..... 38
3. CONTROL PANEL 11	9.2 Emergency Door Opening..... 41
3.1 Control Panel Description 11	10. TECHNICAL DATA..... 42
3.2 Program Chart..... 12	11. INSTALLATION 42
3.3 Program Options Compatibility 13	11.1 Unpacking..... 42
3.4 Options..... 14	11.2 Positioning..... 44
3.5 Settings 17	11.3 Water Inlet 45
3.6 Start/Pause (▶) and Add Clothes (👕) Touchpad... 18	11.4 Water Drainage 45
4. BEFORE FIRST USE 18	11.5 Electrical Connection..... 47
5. DAILY USE 19	12. ENVIRONMENT CONCERNS .. 47
5.1 Loading The Laundry 19	12.1 Packaging Materials..... 47
5.2 Detergent Dispenser With Autodose Tanks And Manual Compartments..... 19	12.2 Old Machine 47
5.3 Options Setting..... 25	12.3 Ecological Hints..... 47
5.4 Starting A Cycle (▶) 26	13.  WI-FI CONNECTIVITY SETUP SETUP 48
5.5 Interruption Of A Program 26	13.1 Download and installing and configuring “Electrolux Life” App*..... 48
5.6 Changing A Program 26	13.2  Remote Start 49
5.7 Changing The Options 26	13.3 Over-the-air update..... 49
5.8 Opening The Door..... 26	14. WARRANTY 51
5.9 At The End Of The Program... 27	
5.10 When The Washing Program Is Completed, But There Is Water In The Drum..... 27	
5.11 AUTO Off Mode 27	
6. WASHING HINTS 28	
6.1 Sorting The Laundry..... 28	
6.2 Temperatures 28	
6.3 Before Loading The Laundry... 28	
6.4 Maximum Loads..... 28	
6.5 Removing Stains 28	
6.6 Detergents Type And Quantity Of Detergent..... 29	
7. INTERNATIONAL WASH CODE SYMBOLS..... 30	

1. SAFETY INFORMATION

1.1 Conditions Of Use

This appliance is intended to be used in household and similar applications such as:

- staff kitchen areas in shops, offices and other working environment ;
- farm houses;
- by clients in hotels, motels, and other residential type environments;
- bed and breakfast type environments;
- areas for communal use in blocks of flats or in launderettes.

 **WARNING!** The appliance must not be supplied through an external switching device, such as timer, or connected to a circuit that is regularly switched on and off by utility.

In the interest of your safety and to ensure the correct use, before installing and first using the appliance, read this user manual carefully, including its hints and warnings.

To avoid unnecessary mistakes and accidents, it is important to ensure that all people using the appliance are thoroughly familiar with its operation and safety features.

Save these instructions and make sure that they remain with the appliance if it is moved or sold, so that everyone using it through its life will be properly informed on appliance use and safety.

1.2 Child Safety

- This washing machine is not intended for use by young children or infirm persons without supervision.
 - Young children should be supervised to ensure that they do not play with the appliance.
 - The packaging components (e.g. plastic film, polystyrene) can be dangerous to children - danger of suffocation! Keep them out of children's reach.
 - Keep all detergents in a safe place out of children's reach.
 - Make sure that children or pets do not climb into the drum.
 - This machine is provided with child safety lock option () to prevent children playing with the control panel. (see page 17)
-

1.3 General Safety

- It is dangerous to alter the specifications or attempt to modify this product in any way.
- During high temperature wash program the door glass may get hot. Do not touch it!
- Make sure that small pets do not climb into the drum. To avoid this, please check inside the drum before using the appliance.
- Any objects such as coins, safety pins, nails, screws, stones or any other hard, sharp material can cause extensive damage and must not be placed into the machine.
- Wash small items such as socks, laces, washable belts etc in a washing bag or pillow case as it is possible for such items to slip down between the tub and the inner drum.
- Only use manufacturer's recommended quantities of fabric softener and detergent. Damage to the fabric or appliance can occur if you exceed the recommended amount.
- Do not use your washing machine to wash articles with whalebones, material without hems or torn material.
- Always unplug the appliance and turn off the water supply after use, clean and maintenance.
- This appliance is not intended for use by persons (including children) with reduced physical, sensory or mental capabilities, or lack of experience and knowledge, unless they have been given supervision or instruction concerning use of the appliance by a person responsible for their safety.

- Under no circumstances should you attempt to repair the machine yourself. Repairs carried out by inexperienced persons may cause injury or serious malfunctioning. Contact your local Service Centre. Always insist on genuine spare parts.



For safety reasons do not use double adaptors, extension cords and multi-plug adaptors.

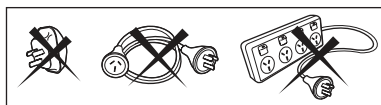

1.4 Installation

- This appliance is heavy. Care should be taken when moving it.
- When unpacking the appliance, check that it is not damaged. If in doubt, do not use it and contact the Service Centre.
- All packing and transit bolts must be removed before use. Serious damage can occur to the product and to property if this is not adhered to. See relevant section in the user manual.
- After having installed the appliance, check that it is not standing on the inlet and drain hose and the worktop is not pressing the electrical supply cable.
- If the appliance is installed on a carpeted floor, please adjust the feet in order to allow air to circulate freely.
- Always be sure, that there is no water leakage from hoses and their connections after the installation.
- Any plumbing work required to install this appliance should be carried out by a qualified plumber.
- Any electrical work required to install this appliance should be carried out by a qualified electrician.



May cause electric shock! if the machine is not connected to an earthed/ground system. DO NOT touch the wet clothes and metal parts.

1.5 Use

- Only wash fabrics which are designed to be machine washed. Follow the instructions on each garment label.
- Do not overload the appliance. See the relevant section in the user manual.
- Before washing, ensure that all pockets are empty and buttons and zips are fastened. Avoid washing frayed or torn articles and treat stains such as paint, ink, rust, and grass before washing.
- Garments which have been in contact with volatile petroleum products should not be machine washed. If volatile cleaning fluids are used, care should be taken to ensure that the fluid is removed from the garment before placing in the machine.
- Never pull the power supply cable to remove the plug from the socket; always take hold of the plug itself.
- Never use the washing machine if the power supply cable, the control panel, the working surface or the base are damaged so that the inside of the washing machine is accessible.

2. PRODUCT DESCRIPTION

2.1 Parts

Worktop

Detergent/Softener
Dispenser
(see page 19)

Control Panel
(see page 11)

Cabinet

Door

Front Panel

Drain Pump Filter
(see page 33)

Level Adjustment
Feet (Front)

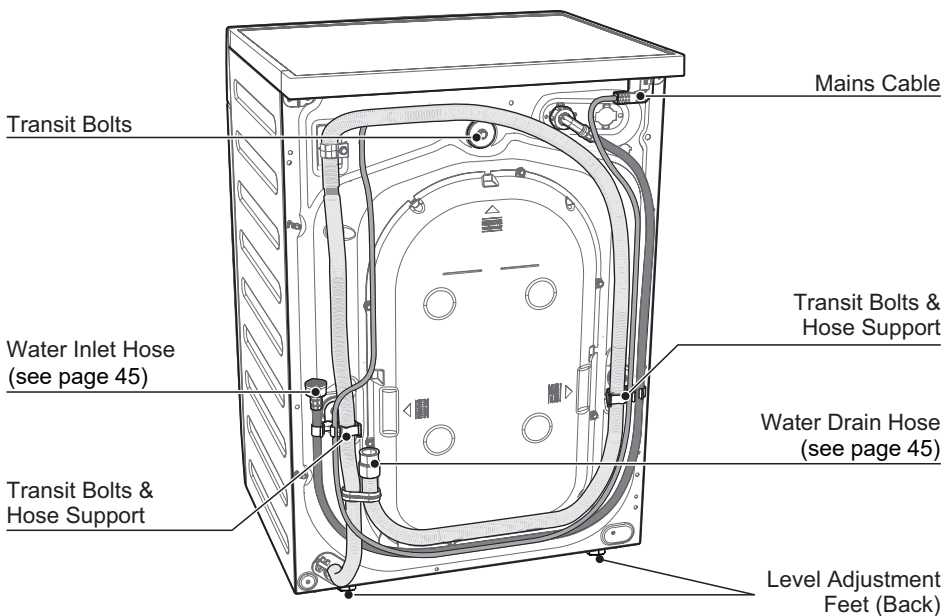

Detergent dispenser with AutoDose tanks and manual compartments

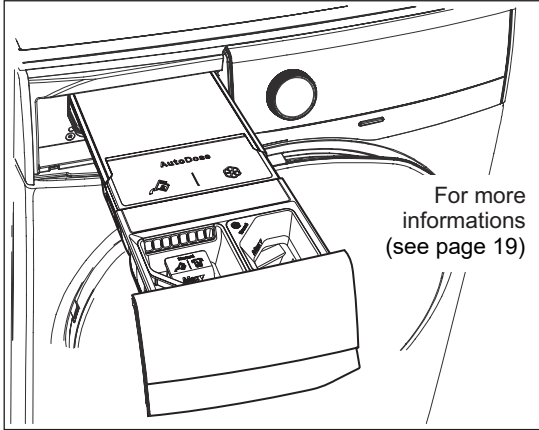

Door (when open) for more informations, see page 19

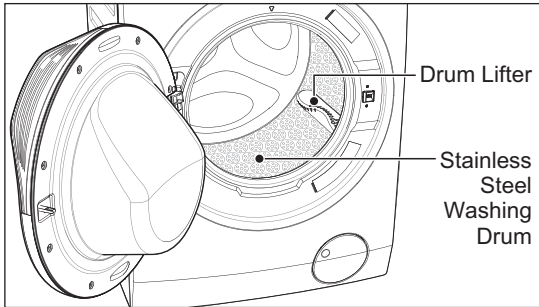

Drain Pump Filter (when open)

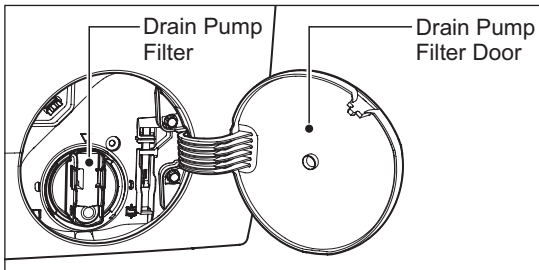

Level Adjustment Feet

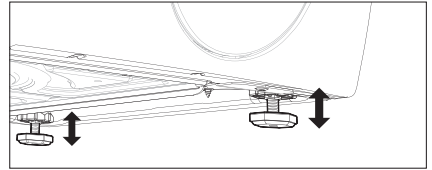

Transit Bolt (when remove)

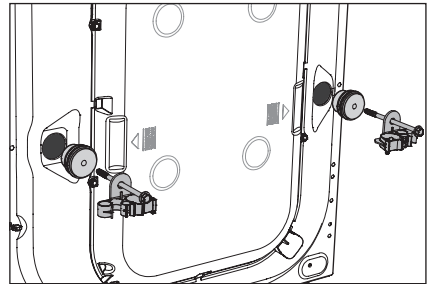
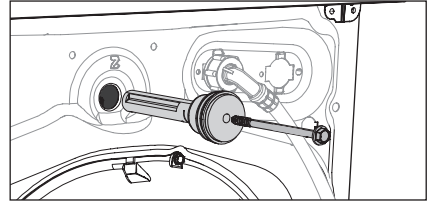

! Transit bolts must be removed before using the appliance.

2.2 Accessories

Plastic Caps

To close the holes on the rear side of the cabinet after the removal of the transit bolts.



Plastic Hose Guide

To connect the drain hose on the edge of a sink.

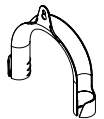

Spanner

To adjust levelling legs.
To remove the transit bolts.

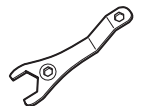

2.3 Load Sensor

This machine has “Load Sensing Device” which shows how much load you put in the machine and maximum load recommended for selected wash program.

- i** The display shows these indicators when the door is open.
- i** The weight shown on display is an approximate weight only.
- i** For correct operation of the load sensor, activate the appliance and set a wash program **BEFORE** loading the laundry in the drum.

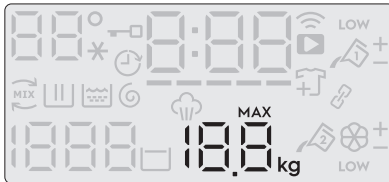

- The display will show “MAX” when max limit is reached for selected program.
 - On the display, the weight of the laundry updates by 0.5 kg steps.
 - The weight is a general indication that changes with the type of the laundry.
 - If you exceed the max weight limit of a program, the symbol “MAX” will start flashing if the load in the drum is more than recommended load, even after the door is closed.
-

2.4 The Autodose Technology (Autodosing)

Introduction

Using the right amount of detergent and fabric softener not only improves the wash performance of your machine it is also beneficial for your clothes and environment by avoiding excessive detergent usage.

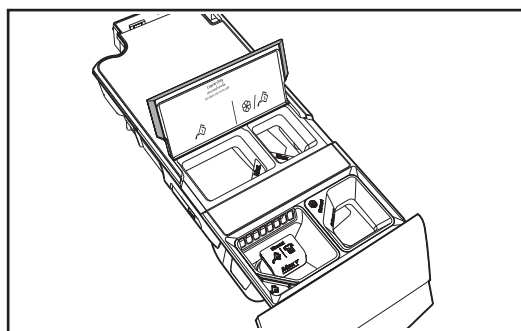

This appliance is equipped with an automatic dosing system enabling the machine to automatically dispense the right amount of detergent and fabric softener for selected wash cycle based on laundry weight.





 AutoDose detergent tank.

 AutoDose fabric softener tank.

The appliance is pre-set by the factory to suit most users habits.

When Either of Auto dose features are selected, relevant symbols  or  are shown on display. If one or both options are not shown on the display, detergent and softener should be added manually.

 **Note: Auto dose is not available for some wash programs as some garments require special detergents and treatments.**

 Auto dose detergent is available for the following wash programs:

- Cottons
- Mixed
- Delicates
- Bedding
- Energy Saver
- Sports
- Quick 15
- Daily 39
- Full Wash 60

 **AutoDose Fabric Softener;** Program available are:

- Cottons
- Mixed
- Delicates
- Bedding
- Energy Saver
- Rinse + Spin
- Sports
- Wool
- Quick 15
- Daily 39
- Full Wash 60

 **When Auto dosing is disabled, use manual detergent and fabric softener compartments.**

 **For more informations, refer to page 19 to page 25.**

3. CONTROL PANEL

3.1 Control Panel Description

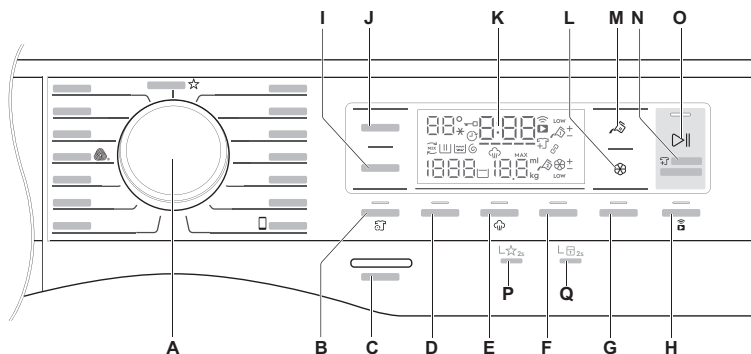



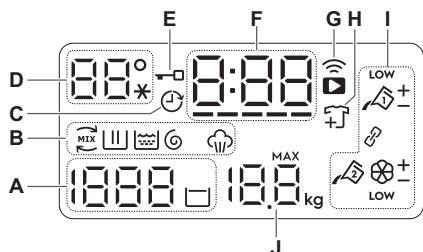

- | | |
|---------------------------------|--|
| A Program knob | J Temp touchpad |
| B SensorWash touchpad | K Display |
| C On/Off button | L Autodose - Softener |
| D Stain touchpad | M Autodose - Detergent |
| E Hygienic Care touchpad | N Pause to add Clothes option |
| F Prewash touchpad | O Start/Pause touchpad |
| G Delay End touchpad | P Favourite program save option |
| H Remote touchpad | Q Child safety lock option |
| I Spin touchpad | |

Display



- | | |
|---|---|
| A Spin Speed | C Delay End Icon |
| □ Rinse Hold Icon | D Temperature ("*" represents Cold water) |
| B Program Phase Indication Icon | E Door Lock Icon |
| <ul style="list-style-type: none"> ☼ Ultramix phase, █ Wash phase, ▒ Rinse phase, ⌚ Spin phase, ☁ Vapour phase | F Program Duration / Delay End Time / Alarm Code |
| | G Remote Icon (📶 Wi-Fi connection indicator, 📶 Remote connection indicator.) |
| | H Add Clothes Icon |
| | I AutoDose Icon |
| | J Maximum Load Capacity of Selected Program / Load Weight |

3.2 Program Chart

Program; Temperature range	Max. Spin Speed	Max. Load (Dry Clothes)	Type of load and soil level
Cottons; Cold to 90°C	1400 rpm	10 kg	White and coloured cotton.
Mixed; Cold to 60°C	1200 rpm	4 kg	Synthetic or mixed fabric items.
Delicates; Cold to 40°C	1200 rpm	4 kg	Delicate fabrics such as acrylics, viscose, polyester items.
Bedding; Cold to 60°C	800 rpm	3 kg	Special program for one synthetic blanket, duvet, bedspread and so on.
Vapour Refresh	–	1.5 kg	This cycle removes odours and helps to dewrinkle the laundry.  Do not add detergent.
Energy Saver; Cold, 40°C ¹⁾	1400 rpm	10 kg	White and colourfast cotton. Set this program to have a good washing results and decrease the energy consumption. The time of the washing program is extended.
 App Program	–	–	You can send any additional program from Mobile Application to store at this program position and can recall to using it everytime when you rotate program knob to this position. This can be done through the App.  Program “Outdoor” is the default stored program from factory.
Spin	1400 rpm	10 kg	To spin the laundry and drain the water in the drum.
Rinse + Spin	1400 rpm	10 kg	To rinse and spin the laundry.
Sports; Cold to 40°C	1200 rpm	4 kg	A gentle program designed for mixed fabrics found in delicate clothes.
Wool  ; Cold to 40°C	1200 rpm	2 kg	Specially tested program for woollen garments bearing the “Pure new woollen, non-shrink, machine washable” label.
Quick 15; Cold to 30°C	1200 rpm	1.5 kg	Lightly soiled synthetics or mixed fabrics.
Daily 39; 30°C, 40°C	1200 rpm	5.5 kg	Daily wear coloured cotton clothes such as shirts, blouses, towels and undergarments. Ideal for low level of soil.

Program; Temperature range	Max. Spin Speed	Max. Load (Dry Clothes)	Type of load and soil level
Full Wash 60; 30°C to 60°C	1400 rpm	10 kg	Daily wear coloured cotton clothes such as shirts, blouses, towels and undergarments. Ideal for normal level of soil.
Favourite	–	–	Recall your favourite program.

1) Energy Saver Program with Temperature 40degC, Spin speed 1400rpm, Off AutoDose Detergent, Off Autodose Softener options selected is recommended for a full load of normally soiled cotton and is the Energy and Water rating label program.

Woolmark Apparel Care - Blue



The wool wash cycle of this machine has been approved by The Woolmark Company for the washing of wool garments labelled as “hand wash” provided that the garments are washed according to the instructions issued by the manufacturer of this washing machine. Follow the garment care label for drying and other laundry instructions. M1361

The Woolmark symbol is a Certification mark in many countries.

3.3 Program Options Compatibility

Program	Option									
	---	□	📄	🌸	👕	☁️ ²⁾	🧼 ¹⁾	📦	🕒	
	No Spin	Rinse Hold	Auto Dose	Auto Dose	Sensor Wash	Stain ²⁾	Hygienic ¹⁾ Care	Prewash	Delay End	
Cottons	■	■	■	■	■	■	■	■	■	■
Mixed	■	■	■	■	■	■	■	■	■	■
Delicates	■	■	■	■	■	■	■	■	■	■
Bedding	■		■	■	■	■	■			■
Vapour Refresh							■			■
Energy Saver	■	■	■	■		■	■	■		■
App Program										
Spin	■									■
Rinse + Spin	■	■		■						■
Sports	■	■	■	■	■				■	■
Wool	■	■		■						■
Quick 15	■	■	■	■						■
Daily 39	■		■	■						■
Full Wash 60	■	■	■	■						■
Favourite										

1) “Hygienic Care” option can be combined with temperature 40 to 90 °C only.

2) “Stain” option can be combined with temperature 40 to 90 °C only.

3.4 Options

Temperature Touchpad

Press this touchpad repeatedly to increase or decrease the wash temperature if you want your laundry to be washed at a temperature different from the one proposed by the washing machine.

Spin Selection Touchpad

Press this touchpad repeatedly to increase or decrease the spin speed or select Rinse Hold, if you want your laundry to be spun at a speed different from the one proposed by the washing machine.

- **No Spin (---)**

No spin option eliminates all the spin phases and increase the number of rinses.

- **Rinse Hold (□)**

By selecting this option the water of the last rinse is not emptied out and the drum turns regularly to prevent the laundry creases.

The door is still locked to indicate that the water must be emptied out.

 The door stays locked with the water in the drum. To continue the cycle, you must press ▷|| (Start/Pause).

AutoDose Liquid Detergent Touchpad

For activating and deactivating the automatic detergent dosing refer to “5.2 Detergent dispenser with AutoDose tanks and manual compartments” on page 19.

AutoDose Fabric Softener Touchpad

For activating and deactivating the automatic fabric softener loading refer to “5.2 Detergent dispenser with AutoDose tanks and manual compartments” on page 19.

Remote () Touchpad

This option allows you to connect washing machine to Wi-Fi network and to link it to your smart phone.

By this functionality you can receive notifications, control and monitor your washing machine from your mobile devices.

Please refer to Chapter “13.  WI-FI CONNECTIVITY SETUP”.

 When the door is open, remote functions are disabled.

Delay End () Touchpad

Before you start the program, this option makes it possible to define the end of the washing program from minimum of 1 hour to maximum of 20 hours.

i If program duration is longer than 3 hours, minimum Delay End option starts from 4 hours.

Press the Delay End touchpad to choose the end time as you wish. The display shows the number of hours and the indicator beside the touchpad is on.

i This option must be selected after choosing the wash program, and before pressing the “Start/Pause” touchpad.

For example, if the program duration of your selected program is 3.20 hours and you define the “Delay End” time to 6 hours. This means your wash program will finish in 6 hours. (See diagram)

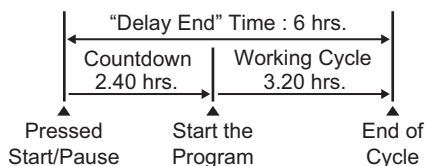

After selecting Delay End time, press Start/Pause touchpad to start the program. Machine will then countdown and update time on the display every hours until it reaches the starting point of the wash cycle.

If you wish to modify or cancel Delay End option after starting the program, follow the steps below:

- set the washing machine to PAUSE by pressing “Start/Pause” touchpad;
- deselect this option by pressing “Delay End” touchpad, the display will show delay time “  ”;
- press the “Start/Pause” to start the program.

SensorWash () Touchpad

Select “SensorWash” option to turn ON the sensors for the dirt and detergent residue.

When using this option, the washing machine will automatically check the dirt level and detergent residue* on your laundry. The machine will automatically adjust the washing time and numbers of rinses according to the load to make sure that your clothes are really clean.

** Only for liquid detergent*

The SensorWash technology consist of 2 different sensors for detection:

1) The 1st Turbidity sensor detects the dirt level at the start of cycle and automatically calculates the actual time needed to remove the level of dirt in the wash; from low dirt levels all the way to the maximum dirt level.

i The initial time displayed on the control panel indicates the time needed for the maximum dirt level.

2) The 2nd Conductivity sensor will check the amount of detergent residue after the first rinse and the machine will calculate the optimum number of rinses (Maximum addition of 2 rinses) needed to make sure that the detergent residue is properly removed.

i Please see details of detergent usage at “Detergents Type and Quantity of Detergent”



Stain Touchpad

Press this touchpad to add the stain phase to a program. The indicator of this option comes on.



Use this function for laundry with hard to remove stains.

You have 2 choices for adding stain remover:

1. If AutoDose Detergent is Off, when you set this function,

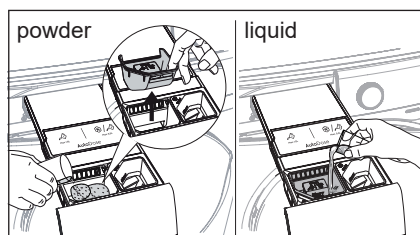
- put the powder stain remover into the compartment “Manual”  (powder) together with powder detergent or
- put the liquid stain remover into the compartment  |  (liquid) together with liquid detergent.



2. If AutoDose Detergent is On, The detergent is dispensed from the AutoDose compartment. You can put stain remover into the compartment “Manual”  (powder) or  |  (liquid).

i This function increases the program duration.

i Stain option can be combined with temperature 40 to 90 °C only.

i If you press AutoDose  button while Stain option is active, AutoDose function is switched off, but Stain option still remains active in manual mode.



Prewash Touchpad

Select this option if you wish your laundry to be pre-washed before the main wash.

Use this option for heavy soil, especially if containing sand, dust, mud and other solid particles.

This option increases the program duration.

You have 2 options for adding prewash detergent:

1. If AutoDose Detergent is Off, put the detergent for Main wash phase into the compartment “Manual”  (for powder) or  |  (for liquid) and pour detergent for Prewash phase directly into the drum.

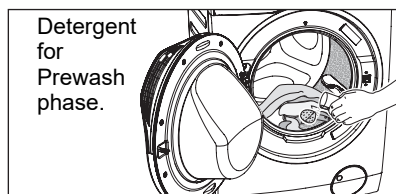

2. If AutoDose Detergent is On, detergent is dispensed from the AutoDose compartment during Prewash phase. So, you do not need to add more detergent.

Hygienic Care () Touchpad

Select this option to add approximately 30 minutes of tumbling in vapour after the rinse cycle.

- Vapour may not necessarily be visible inside the drum during a vapour cycle. Vapour is created below the drum and allowed to naturally rise into the clothes.
- Vapour may not be present during the entire vapour cycle.
- Vapour function is more effective with half load.

- At the end of the Vapour cycle, the clothes will be warmer, softer and detached from the drum.

i If Vapour option is selected, rinse temperatures will be elevated.

During a vapour cycle, you may notice vapour exiting from the drain hose of the washing machine, this is normal and there is no cause for alarm.

3.5 Settings

Save Favourite (☆) Program

Program settings that are frequently used can be saved (e.g. Cotton, 60°C, 1200 rpm, with Prewash and Hygienic Care).

To program/re-program Favourite with your own selections and save them, proceed as follows:

1. Put machine in Stand-By mode.
2. Select your desired wash settings.
3. To save favourite program, press and hold "Hygienic Care" touchpad about 2 seconds and you will hear the sound and "Favourite" LED is flashing.

To recall the favourite wash program, turn selector knob to "Favourite ☆" program. You will get acknowledgement on the screen when the Favourite program is loaded.

i App Program cycle cannot be saved as a Favourite on the appliance.

Child Safety Lock () Option

Your appliance is provided with CHILD SAFETY LOCK which permits you to leave the appliance unsupervised with the door closed without having to worry that children might be injured by or cause damage to the appliance.

i Set this option after pressing the Start/Pause touchpad.

To set "Child Lock" option:

- To activate the function, press and hold "Prewash" touchpad about 2 seconds until the display shows the icon ".

i If you press any touchpad while Child Lock is activated, the icon " will flash on display 3 times along with buzzer sound.

i The touchpads are locked (except for the On/Off button).



- To deactivate the function, press and hold "Prewash" touchpad about 2 seconds until the display shows the icon ".

i This function remains enabled even after the appliance is switched off.

Enabling/Disabling End-Of-Wash Buzzer

This setting permits you to either enable or disable the buzzer at the end of the program. As an example, you might wish to disable this buzzer when you start a wash when going to bed, so that when the wash finished approximately 1 hour later, it will not disturb you through the night.

i Error warning beeps such as critical faults are not disabled.

- To disable the buzzer sound, press "Hygienic Care" and "Stain" touchpads at the same time about 3 seconds, the icon " will show on display along with buzzer sound.
- To return to default configuration press these 2 touchpads at the same time about 3 seconds, the icon " will show on display along with buzzer sound.

3.6 Start/Pause (▷||) and Add Clothes (↻) Touchpad

This touchpad has 2 functions:

1. Start/Pause (▷||)

After you have selected the desired program and options, press this touchpad to start the machine. If you have selected a “Delay End” option, the countdown will begin and will be shown on the display.

To interrupt a program which is running, press this touchpad to pause the machine, the Start/Pause pilot light flashes.

To restart the program from the point at which it was interrupted, press this touchpad again, the Start/Pause pilot light will stop flashing.

2. Add Clothes (↻)

i You can only add clothes when the icon “ ↻ ” shown on the display.



To add clothes:

1. Pressing the “Start/Pause” touchpad to pause the program.
2. Wait for the machine to come to a complete stop before opening the door (wait for door lock “ ↻ ” icon to turn off).
3. Add clothing and close the door.
4. Resume the program by pressing “Start/Pause” touchpad again.

4. BEFORE FIRST USE

i NOTE

During installation or before first use you may observe some water in the machine. This is a residual water left in the machine after a full functional test in the factory to ensure the machine is delivered to customers in perfect working order and is no cause for concern.

1. Make sure that all transit bolts have been removed from the appliance.
2. Ensure that the electrical and water connections comply with the installation instructions.
3. Make sure to fill with liquid detergent and fabric softener the tanks marked by  and . Refer to “Basic Setting” paragraph in “The AutoDose technology” chapter.

4. Put 2 litres of water in the detergent compartment for washing phase. This activates the drain system.
5. Set and start a program for Cotton at the highest temperature without any laundry in the drum (turn off AutoDose system). This removes all possible dirt from the drum and the tub.

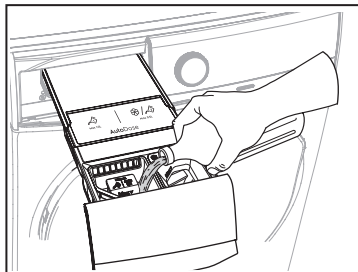

5. DAILY USE

5.1 Loading The Laundry

1. Turn the water tap on.
2. Connect the main plug to the main socket.
3. Press the On/Off button to turn on the washing machine. Turn the knob to set a program. The washing machine will propose a temperature and automatically select the spin value provided for the program you have chosen.
The selector knob can be turned either clockwise or counter-clockwise.

4. Check and remove objects (if there are any) that could be trapped in the fold.

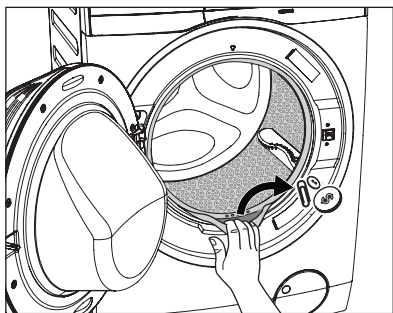

5. Place the laundry in the drum, one item at a time, shaking them out as much as possible.
(Refer to page 28 "WASHING HINTS")
6. Close the door.

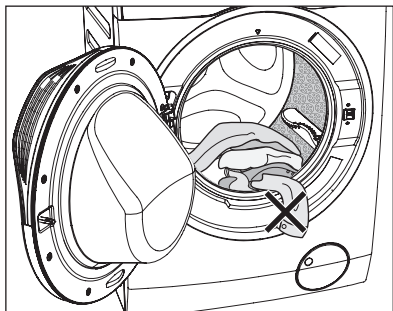
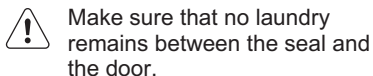

5.2 Detergent Dispenser With Autodose Tanks And Manual Compartments



When using detergent and any other treatments, always follow the instructions that you find on the packaging of the detergent products.

We recommend not to exceed the maximum indicated level in each compartment (Max).

If both AutoDose options are enabled for selected program, detergent and fabric softener are automatically loaded.

If one or both AutoDose options are disabled, manually add detergents to the relevant manual compartments.

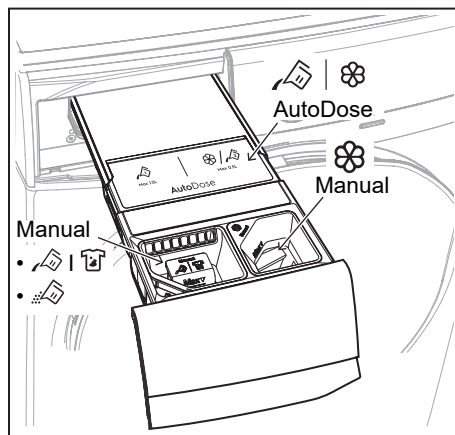

Do not put POWDER detergent in the AutoDose compartment.



- **Auto-dosing** tanks are for liquid detergent and fabric softener only.
- **Manual** compartment for powder detergent.
- **Manual** compartment for liquid detergent.

- i** When using liquid detergent (Manual compartment), make sure that the special container for liquid detergent is inserted. Refer to the "Manual filling the detergent and additives" paragraph in this chapter.

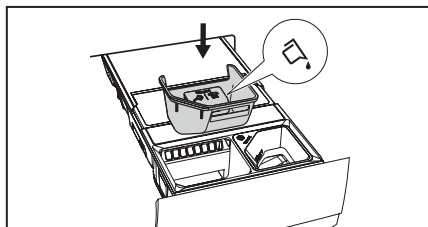

- Manual compartment for liquid additives (fabric softener, fabric conditioner, starch).

- i** **MAX** Maximum level for detergent/additives quantity.

AutoDose

The AutoDose system has 3 modes:

1. **Standard Mode** - Allows you to store liquid detergent and softener in the AutoDose compartments, and to toggle on/off auto dosing of detergent and/or softener.
- 2.* **Dual-Detergent Mode** - Allows you to store 2 different types of liquid detergents in the 2 AutoDose compartments, and toggle on/off or switch between them.
- 3.* **Link Detergent Mode** - Allows you to store 1 type of liquid detergent in both AutoDose compartments, and toggle on/off auto dosing of the liquid detergent.

- i** (*) By factory default, the appliance operates in basic **Standard Mode**. To change configuration to **Dual-Detergent Mode** or **Link Detergent Mode**, you need to complete the setup on the mobile application "Electrolux Life".

Advance functions like fine-tuning, can be enabled on the app to make available on the control panel.

** Apps and services are subject to change without notice.

The pre-set dosages are 50ml for detergent tank and 40ml for fabric softener tank: the optimal configuration to meet majority of use condition.

However, under extreme conditions (very soft or very hard water) and particular type of detergent (such as super concentrated), we recommend to adjust the pre-set dosage by following the instruction given on detergent and fabric softener container: e.g when using super concentrated detergent you may need to reduce the pre-set dosage considerably.

If the washing results are not satisfactory or there is too much foam during washing, you may need to change this setting.

Check on the detergent product instruction to identify the right dosage considering a normal laundry soil level, the actual water hardness and the additional dosage suggested for larger load.

1. Identifying the water hardness level:

Hard water can reduce the effectiveness of the detergent, for this reason detergent manufacturer recommend to adjust the dosage based on water hardness level. Check the water hardness level in your area. The levels are generally indicated as: soft, medium and hard. If necessary, please contact your local water authority to check the water hardness in your area.

2. Identifying the customized detergent dosage:

Check the label in the detergent/fabric softener container suggesting the quantity to use. This suggestion is measured combining three different factors:

- Water hardness level;
- Normal soil level;
- Rated capacity of the appliance (e.g. maximum load capacity 9 kg). If the rated capacity on the product container refers to lower capacity appliances, the customized dosage should be increased.

Filling the detergent and additives on AutoDose system

i Please read “Detergents Type And Quantity Of Detergent” on page 29.

i We recommend that you do not exceed the maximum indicated level (**MAX**).

1. Open the detergent dispenser.

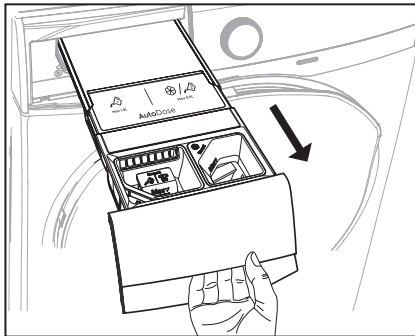

2. Lift up the AutoDose cover lid.

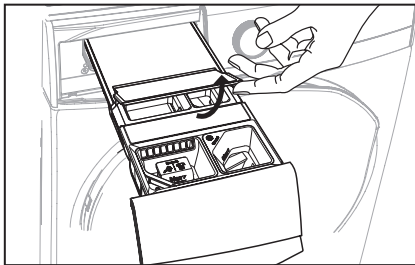

3. Gently pour only liquid detergent in the AutoDose detergent tank . Fill up to the maximum indicated level **MAX**.

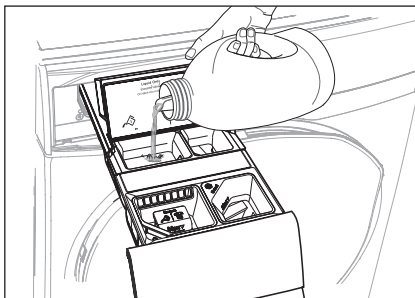

4. Gently pour only liquid softener in the AutoDose fabric softener tank . Fill up to the maximum indicated level **MAX**.

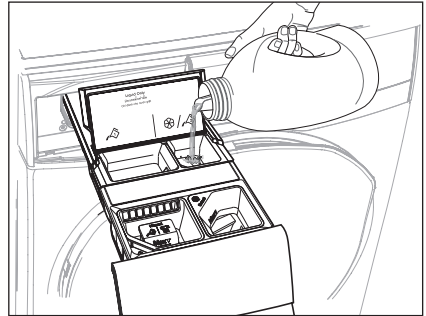

5. Close the AutoDose cover lid.

6. Gently close the detergent dispenser by pushing all the way in.

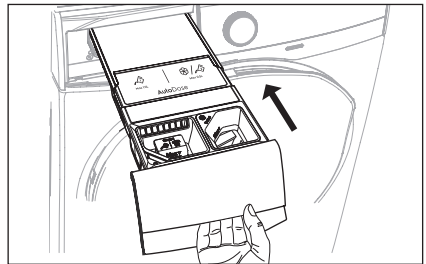

1. Standard Mode

In Standard Mode, you can toggle on/off auto dosing of detergent and softener.

By default, both AutoDose detergent and softener are enabled the first time appliance is powered on.

To Activate/Deactivate AutoDose Detergent ()

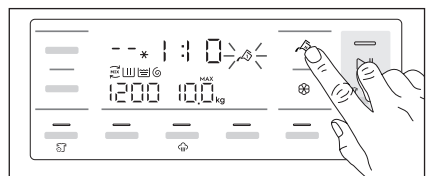

Press AutoDose touchpad to toggle on and off, the relevant symbols will show on display if enabled.

To Activate/Deactivate AutoDose Softener (☼)

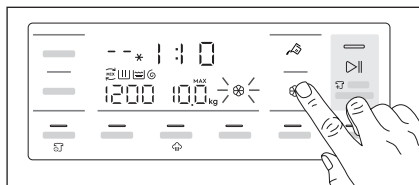



Press AutoDose softener ☼ touchpad to toggle on and off, the relevant symbols will show on display if enabled.

AutoDose configuration mode

i Enter the AutoDose configuration mode before proceeding with any program setting. The configuration mode may cancel temporary settings.

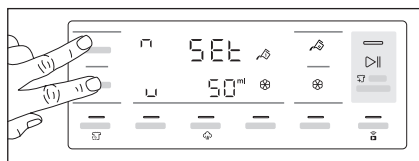
1. Press the On/Off button for a few seconds to activate the appliance.
2. Wait about 10 seconds for appliance internal check.
3. To enter in configuration mode, touch and hold "Temp" and "Spin" touchpads simultaneously for a few seconds until **SEt** appears on display.



4. Press  Detergent touchpad to select configure detergent dosage. Touch the "Temp" touchpad repeatedly to increase and "Spin" touchpad to reduce. Minimum step is 1 ml (you can press and hold touchpad to increase the increment to 10ml/step).

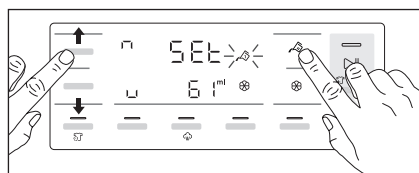

5. Press  Softener touchpad to select configure softener dosage. Touch the "Temp" touchpad repeatedly to increase and "Spin" touchpad to reduce. Minimum step is 1 ml (you can press and hold touchpad to increase the increment to 10ml/step).

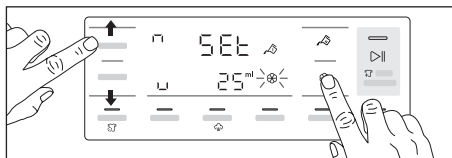

6. To save and exit configuration mode, press and hold "Temp" and "Spin" touchpads combination again for 3 seconds or you can turn the knob to any position.

AutoDose low level indication

 Do not refill the AutoDose tanks unless appliance indicates that one or both tanks are empty.

When the activated tank reaches a low level of detergent, **LOW** indicator blinks slowly and continuously on the display.

It will stop blinking when the compartment is refilled.

If tank is not refilled, once a program has started, the indicator will stop blinking and stay steadily lit. Once the program is finished, it will start blinking again.

If in both tanks detergent level is low, both indicators blink, but only the set dosage for detergent will be displayed.



 If the tanks are filled before the appliance is powered on for the first time, the AutoDose indicator will not blink.

 Refill the tanks with the same detergent and fabric softener as before. If changing either of the liquid detergents, clean the tanks before refilling (see section 8.5 for instructions on how to clean the tanks).

Drawer open indication

When a program is running, the detergent drawer must always be closed.

A sensor in the drawer detects if the drawer is open (or not properly closed) while the program is running. In such case, the appliance will immediately be paused.

If you press the Start/Pause ▷|| touchpad, an error sound is generated and everything in the display will turn off except the AutoDose symbols ( and ) remain lit for a few seconds. Then the display returns to the previous paused state. This will happen even if AutoDose is turned off.

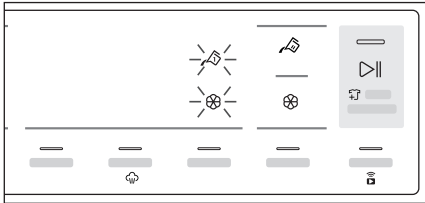

To restart the program, ensure the drawer is properly closed and press Start/Pause ▷|| touchpad.

Manual filling the detergent and additives

You may need to use a different detergent or fabric softener than the ones used in the AutoDose tanks. First, make sure that the AutoDose tanks are disabled and then pour the detergent, fabric softener or other treatments in the manual compartments.

 We recommend that you do not exceed the maximum indicated level (**MAX**).

Manual filling the powder detergent

1. Open the detergent dispenser.
2. Lift out the special container for liquid detergent.

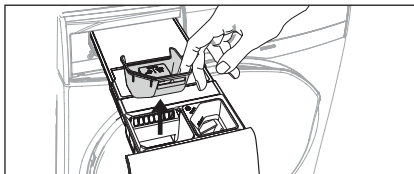

3. Put the powder detergent in the compartment .

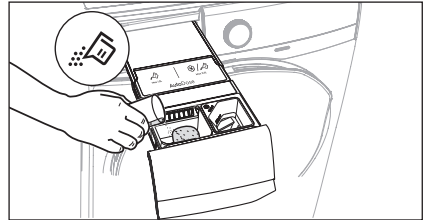

4. Gently close the detergent dispenser by pushing all the way in.

Manual filling the liquid detergent

1. Insert the special container for liquid detergent.

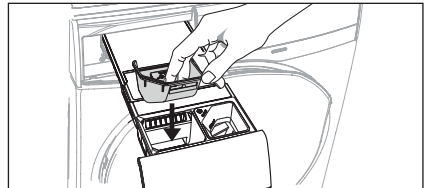

2. Pour the liquid detergent in the compartment .

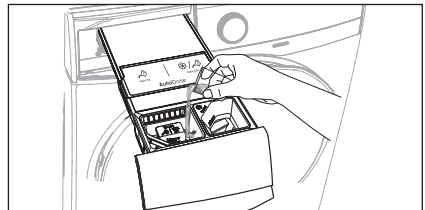

3. If desired, pour the fabric softener in the compartment .

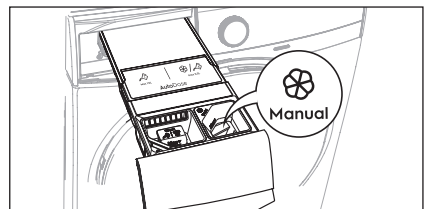

4. Gently close the detergent dispenser by pushing all the way in.

i If the machine has not been used for more than 4 weeks with full tanks, detergent/softener can become viscous or dry out. It is recommended to clean the drawer as indicated in “Care and Cleaning” chapter. (see page 31)



2. Setting AutoDose by using “Electrolux Life” App *

By using Electrolux Life App you can adjust amounts of detergent on Standard Mode and can change configuration to **Dual-Detergent Mode** or **Link Detergent Mode**.

* Apps and services are subject to change without notice.

• To Adjust Detergent Amounts on Standard Mode



Fine-tuning feature can be enabled by adding the appliance into the Electrolux Life App. Pressing on the AutoDose Detergent () touchpad will toggle through the following options:

-  Normal dosage (default)
-  A little more detergent
-  A little less detergent

i Fine-tuning settings is not “permanent”, and will return to normal dose after the cycle ends.

• To Adjust Softener Amounts on Standard Mode

Fine-tuning feature can be enabled by adding the appliance into the Electrolux Life App. Pressing on the AutoDose Softener () touchpad will toggle through the following options:

-  Normal dosage (default)
-  A little more softener

i Fine-tuning settings is not “permanent”, and will return to normal dose after the cycle ends.

• Dual-Detergent Mode

In Dual-Detergent Mode, you can select which of the 2 different detergents that are stored in the AutoDose compartments to be activated (For example, you can store compartment 1 with detergent for adult and compartment 2 with detergent for baby).

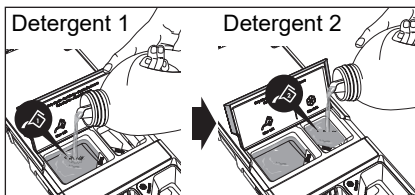



i AutoDose Softener () touchpad is disabled in this mode, the display will show “---” when touched it.

To Activate/Deactivate Detergent

Touch AutoDose Detergent () touchpad to toggle through the following options:

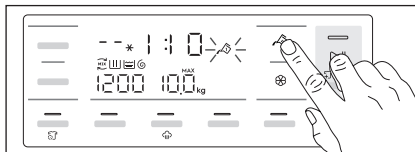
-  using main compartment





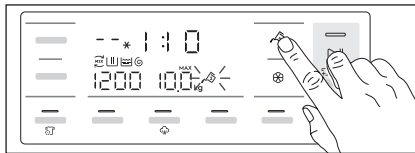



-  using secondary compartment



To Adjust Detergent Amounts

Fine-tuning feature can be enabled by adding the appliance into the Electrolux Life App. Pressing on the AutoDose Detergent () touchpad will toggle through the following options:

-  Detergent 1 - Main compartment, normal dosage (default)
-  Detergent 1 - Main compartment, a little more detergent
-  Detergent 1 - Main compartment, a little less detergent

-  Detergent 2 - Secondary compartment, normal dosage
-  + Detergent 2 - Secondary compartment, a little more detergent
-  - Detergent 2 - Secondary compartment, a little less detergent

 Fine-tuning settings is not “permanent”, and will return to normal dose after the cycle ends.

• Link Mode

In Link Mode, both compartments are filled with the same detergent. You can toggle On/Off dosing of AutoDose detergent.

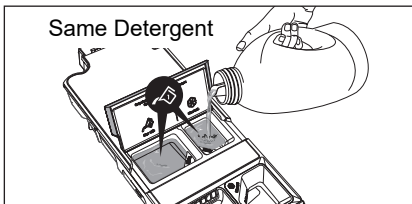

 AutoDose Softener touchpad is disabled in this mode, the display will show “---” when touched it.

To Activate/Deactivate Detergent

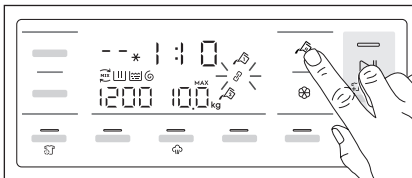

Touch AutoDose Detergent  touchpad to toggle on/off both detergent tanks.

Detergent 1 and Detergent 2 symbols will link together with the Link symbols shown in the picture below.



To Adjust Detergent Amounts

Fine-tuning feature can be enabled by adding the appliance into the Electrolux Life App. Pressing on the AutoDose Detergent () touchpad will toggle through the following options:

-  Normal dosage (default)
-  A little more detergent
-  A little less detergent

 Fine-tuning settings is not “permanent”, and will return to normal dose after the cycle ends.

5.3 Options Setting

1. If you want your laundry to be spun or use temperature different from the one proposed by the washing machine, press “Spin” and “Temp” touchpads repeatedly to change the spin speed and temperature. Press the option touchpads, if you want your laundry to be washed with special functions.

NOTE

- Different functions can be combined which is dependent on the program selected.
 - If an option is not compatible with the wash program selected, the symbol “---” will flash on display along with buzzer sound.
2. If you want to define the end of the washing program, press the “Delay End” touchpad repeatedly to choose your washing machine working time.

5.4 Starting A Cycle (▷||)

To start a program, press the Start/Pause touchpad. The corresponding pilot light will stop flashing and a default program duration will be displayed on the screen.

After approx. 15 minutes from the start of a program:

- The appliance will automatically adjust the selected program duration according to the type and size of the load.
- The display will show adjusted program duration.

NOTE

If you press any touchpad while a program is operating, the symbol “- - -” will flash on display along with buzzer sound. (except Start/Pause touchpad and On/Off button)

5.5 Interruption Of A Program

- To pause, press Start/ Pause. The indicator will start flashing.
- Press the Start/Pause again. The program will continue.

5.6 Changing A Program

Changing a running program **is possible only by switching off** the appliance.

- Press the “On/Off” button to cancel the program and to turn off the appliance.
- Press the “On/Off” button again to start the appliance.

Now you can set a new wash program and change any available options. Press Start/Pause to start the new program.

NOTE

The appliance will not drain the water (except programs; Vapour Refresh, Spin, Rinse + Spin, Tub Clean).

5.7 Changing The Options

It may be possible to change some of the options after a wash program has started.

1. Press the touchpad Start/Pause. The indicator will start flashing.
2. If available change the options that you wish.
3. Press Start/Pause again. The program will continue.

5.8 Opening The Door

While a program or the Delay End is operating, the appliance door is locked and the display shows the indicator “”. First, set the machine to PAUSE by pressing the “Start/Pause” touchpad. Wait until the door lock indicator goes off, then the door can be opened.

If the door lock indicator “” does not disappear, this means that the machine is already heating and the water level is above the bottom edge of the door or the drum is turning. In this case the door CAN NOT be opened. If you need to open it, you must drain the water to open the door.

In case of Remote () function is activated, when program cycle end and anticrease phase is complete. The door will remain locked for 5 minutes, if you want to open the door at that time, press any touchpads once to turned off function then the door is unlocked.



In case of emergency please refer to “Emergency door opening” on page 41.

5.9 At The End Of The Program

- The appliance stops automatically.
- The acoustic signal will operate.
- The display will show “E 7d”.
- The indicator of the touchpad Start/Pause goes off.
- The door lock indicator “ ” goes off.
- Remove the laundry from the appliance. Make sure that the drum is empty.
- Keep the door partly open, to prevent the mildew and odours.
- Turn off the water tap.

NOTE

At the end of the program, the time remaining can suddenly decrease from 7 minutes or less to 0 due to the overestimated total program time during the load sensing phase. In some cases (with perfectly balanced load) the program time can be shorter than the time estimated after the load sensing phase is completed. This is a normal behavior of the machine and not a cause for concern as it does not compromise its performance.



5.10 When The Washing Program Is Completed, But There Is Water In The Drum

(Option “Rinse Hold  ” is used)

- The drum turns regularly to prevent the creases in the laundry.
- The indicator “Start/Pause” flashes to remind you to drain the water.
- The door lock indicator “ ” is on. The door stays locked.

 **You must drain the water to open the door.**

To drain the water:

1. Press the “Start/Pause  ” touchpad. The appliance drains the water and spins with the maximum spin speed for selected program.
Alternatively, before pressing the “Start/Pause” touchpad, you can press the “Spin ” touchpad to change the spin speed. You can select “No Spin (---)”, if you want the machine to only drain the water.
2. When the program is completed and the door lock indicator “ ” goes off, you can open the door.
3. Press the “On/Off” button to deactivate the appliance.

NOTE

After approximately 18 hours, if you do not press Start/Pause touchpad, the appliance will drain and spin automatically (except for “Wool” program) .

5.11 AUTO Off Mode

The AUTO Off mode automatically deactivates the appliance to decrease the energy consumption when:

- You do not press any buttons for 5 minutes before you press “Start/Pause”.
 - Press the “On/Off” button to activate the appliance again.
- After 5 minutes from the end of the washing program.
 - Press the “On/Off” button to reactivate the appliance. Display will show the end of the last wash.
 - Press any touchpad again to show the last wash program.

6. WASHING HINTS

6.1 Sorting The Laundry

Follow the wash code symbols on each garment label and the manufacturer's washing instructions. Sort the laundry as follows: whites, coloureds, synthetics, delicates, woollens.

6.2 Temperatures

Temp	Soil level
90°C	For normally soiled white cottons and linen (e.g. tea cloths, towels, tablecloths, sheets...).
60°C 50°C	For normally soiled, colourfast garments (e.g. shirts, night dresses, pajamas....) in linen, cotton or synthetic fibres and for lightly soiled white cotton (e.g. underwear).
40°C 30°C Cold	For delicate items (e.g. net curtains), mixed laundry including synthetic fibres and woollens bearing the label pure new wool, machine washable, non-shrink.

6.3 Before Loading The Laundry

- Make sure that no metal objects are left in the laundry (e.g. coin, hair clips, safety pins, pins).

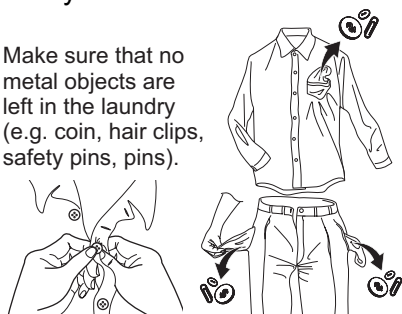

- Button up pillowcases, close zip fasteners, hooks and poppers. Tie any belts or long tapes.

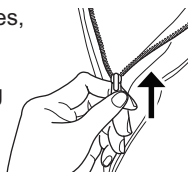

- Wash bras, pantyhose and other delicates in a mesh laundry bag, which you can purchase from your supermarket.
- Make sure that you wash lint collectors separately from lint producers.
- Never wash whites and coloured fabrics together. Whites may lose their "whiteness" in the wash.
- New coloured items may run in the first wash; they should therefore be washed separately the first time.
- Remove persistent stains before washing.
- Rub particularly soiled areas with a special detergent or detergent paste. Treat curtains with special care. Remove hooks or tie them up in a bag or a net.

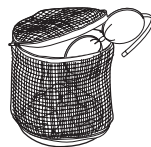

6.4 Maximum Loads

Recommended loads are indicated in the program charts on page 12.

General rules:

Clothes Load	Quantity
Cotton, linen	drum full but not too tightly packed;
Synthetics	drum no more than half full;
Delicate fabrics and woollens	drum no more than one third full.

Washing a maximum load makes the most efficient use of water and energy. For heavily soiled laundry, reduce the load size.

6.5 Removing Stains

WARNING!

Pre-treatment sprays and stain remover can damage plastic components on your washing machine. If you use pre-treatment sprays or stain removers, apply them to the clothing well away from your washing machine.

Stubborn stains may not be removed by just water and detergent. It is therefore advisable to treat them prior to washing.

Blood: treat fresh stains with cold water. For dried stains, soak overnight in water with a special detergent then rub in the soap and water.

Oil based paint: moisten with benzine stain remover, lay the garment on a soft cloth and dab the stain; treat several times.

Dried grease stains: moisten with turpentine, lay the garment on a soft surface and dab the stain with the fingertips and a cotton cloth.

Rust: oxalic acid dissolved in hot water or a rust removing product used in cold water. Be careful with rust stains which are not recent since the cellulose structure will already have been damaged and the fabric tends to hole.

Mould stains: treat with bleach, rinse well (whites and fast coloureds only).

Grass: soap lightly and treat with bleach (whites and fast coloureds only).

Ball point pen and glue: moisten with acetone (*), lay the garment on a soft cloth and dab the stain.

Lipstick: moisten with acetone (*) as above, then treat stains with methylated spirits. Remove any residual marks from white fabrics with bleach.

Red wine: soak in water and detergent, rinse and treat with acetic or citric acid, then rinse. Treat any residual marks with bleach.

Ink: depending on the type of ink, moisten the fabric first with acetone (*), then with acetic acid; treat any residual marks on white fabrics with bleach and then rinse thoroughly.

Tar stains: first treat with stain remover, methylated spirits or benzine, then rub with detergent paste.

(*) do not use acetone on artificial silk.

6.6 Detergents Type And Quantity Of Detergent

Low sudsing detergent is required for this washing machine to prevent oversudsing problems, unsatisfactory washing result and harm to the machine.

Low sudsing detergents designed for front load washing machines are labelled "Front Loading", "high efficiency", "HE", such as Cold Power for Front Loaders or "Matic".

Do not use wrong types of detergent, such as Top Loading, Handwash detergent or Soap-Based products in your frontload washing machine. This can result in excessive suds, longer cycle time, low spin speeds, poor rinsing and overloading of the motor.

Quantity of detergent to be used

The choice of detergent and use of correct quantities not only affects your wash performance, but also helps to avoid waste and protect the environment. Although biodegradable detergents contain substances which in large quantities can upset the delicate balance of nature.

The choice and quantity of detergent will depend on ;

- type of fabric (delicates, woollens, cottons, etc.) ;
- the colour of clothes ;
- size of the load ;
- degree of soil ;
- wash temperature ; and
- hardness of the water used.

Water hardness is classified by so-called "degrees" of hardness.

Information on hardness of the water in your area can be obtained from the relevant water supply company, or from your local authority.

You may have to try using the detergent quantity as per manufacturers' instructions then compare the wash result to the list below and adjust the amount of detergent for your future washes accordingly.

Not enough detergent causes:

- the washload to turn grey,
- greasy clothes.

Too much detergent causes:

































- oversudsing,
- reduced washing effect,
- inadequate rinsing.

Use less detergent if:

- you are washing a small load,
- the laundry is lightly soiled,
- large amounts of foam during washing.

7. INTERNATIONAL WASH CODE SYMBOLS

 These symbols appear on fabric labels, in order to help you choose the best way to treat your laundry.

 Energetic wash	 Max. wash temperature 95 °C	 Max. wash temperature 60 °C	 Max. wash temperature 40 °C	 Max. wash temperature 30 °C	 Hand wash	 DO NOT wash at all
 Delicate wash			 			
 Bleaching	 Bleach in cold water		 DO NOT bleach			
 Ironing	 Hot iron max. 200 °C	 Warm iron max. 150 °C	 Lukewarm iron max. 110 °C	 DO NOT iron		
 Dry cleaning	 Dry cleaning in all solvents	 Dry cleaning in perchlorethylene, petrol, pure alcohol, R 111 & R 113		 Dry cleaning in petrol, pure alcohol and R 113	 DO NOT dry clean	
 Drying	 Flat	 On the line	 On clothes hanger	 High temperature  Low temperature Tumble dry	 DO NOT tumble dry	

8. CARE AND CLEANING

WARNING!

You must DISCONNECT the appliance from the electricity supply, before you can carry out any cleaning or maintenance work.

8.1 External Cleaning

Clean the appliance only with soap and warm water. Fully dry all the surfaces.

CAUTION!

Do not use alcohol, solvents or chemical products.

8.2 Descaling

The water we use normally contains lime. It is a good idea to periodically use a water softening powder in the machine.

Do this separately from any laundry washing, and according to the softening powder manufacturer's instructions.

This will help to prevent the formation of lime deposits.

8.3 After Each Wash

Leave the door open for a while. This helps to prevent mould and stagnant smells forming inside the appliance.

Keeping the door open after a wash will also help to preserve the door seal.

8.4 Maintenance Wash

With the use of low temperature washes it is possible to get a build up of residues inside the drum.

We recommend to use maintenance wash to clean the drum regularly to remove any residue.

To run a maintenance wash:

- The drum should be empty of laundry.
- Select the "Cottons 90°C" program.
- Press Start/Pause to start the program.

8.5 Cleaning The Detergent Dispenser And The Autodose Tanks

 Before cleaning, make sure that the all compartments are empty.

To prevent possible deposits of dried detergent, clotted fabric softener, formation of mould in the detergent dispenser and/or clotted liquid additives in the AutoDose tanks, once in a while carry out the following cleaning procedure:

 Cleaning procedure is also suggested when brand or type of detergent, fabric softener or additives are changed inside the tanks.

1. Open the detergent dispenser. Press the catch as indicated in the picture and pull the detergent dispenser out.

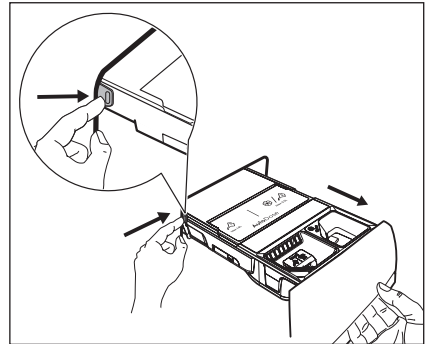

2. Remove the insert for the softener and, if inserted, the special container for liquid detergent.

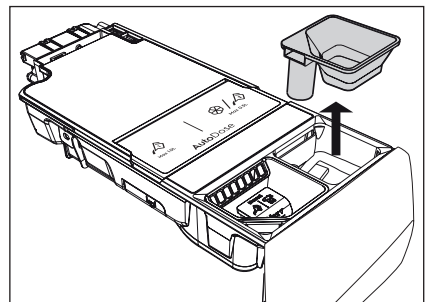

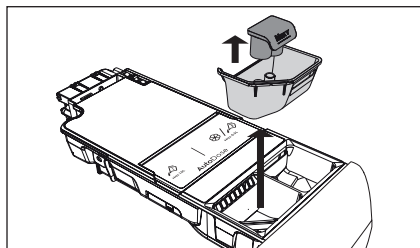

3. Open the drain plugs of each tank and empty them into a sink.

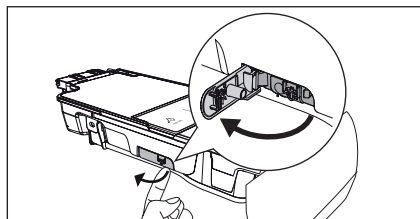

4. Press the catch on the back as indicated in the picture and lift up the top cover to remove it.

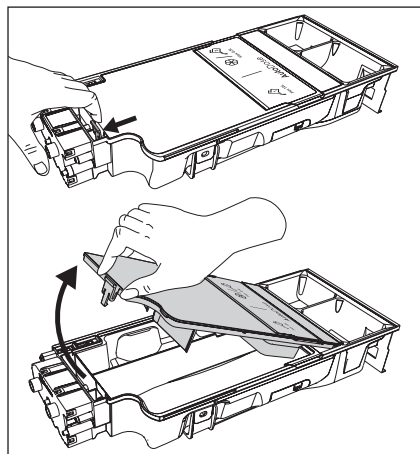

5. Wash the drawer and all inserts under running water.

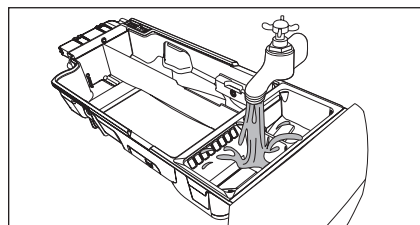

! CAUTION!

Do not use sharp or metal brushes and sponges.

6. Turn the dispenser up side down and open the bottom cover as indicated in the picture.

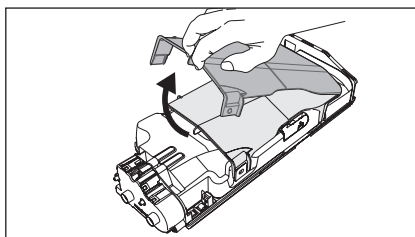

7. Make sure that all detergent residue is removed from the conveyor. Use only soft damp cloth.

8. Put bottom cover back to its position by aligning its holes on drawer hooks as indicated in the picture. Close it till "click" sound is heard.

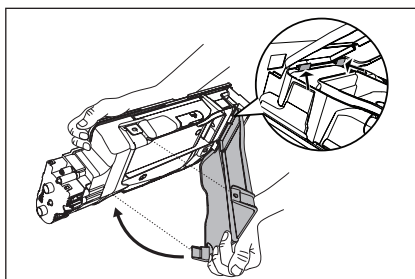

! WARNING!

Do not clean with any sharp and metal brushes or any tools to avoid damaging pumps and sensors located the back of the detergent drawer. If necessary, use only soft damp cloth.

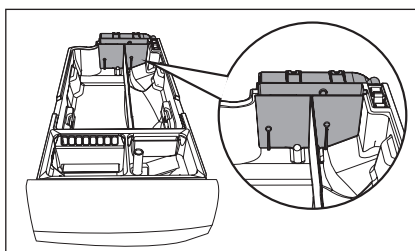

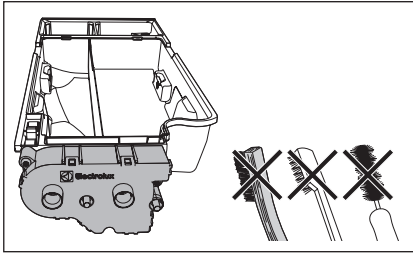

! WARNING!

If some residues remain on the back area of tanks, soak detergent drawer in a warm water. Do not use tools to clean it. Before soaking, remove the handle by pressing the button and slide the handle as indicated in the picture.

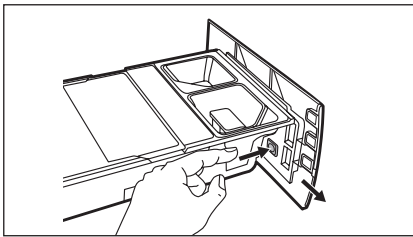

9. Make sure that all detergent residue is removed from the upper and lower part of the recess. Use a small brush to clean the recess.

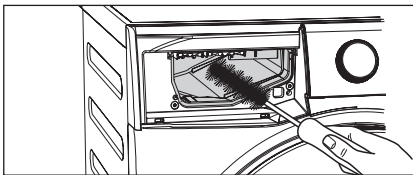

10. Reassembly the drawer as follows:

- Place the handle if it was removed.
- Place the bottom cover and press till "click" sound is heard.
- Place the top cover on the tanks compartment and press till "click" sound is heard.
- Replace components on manual compartment.

11. Insert the detergent dispenser into the guide rails and gently close it till "click" sound is heard. Run the Quick 15 program without any clothes in the drum.

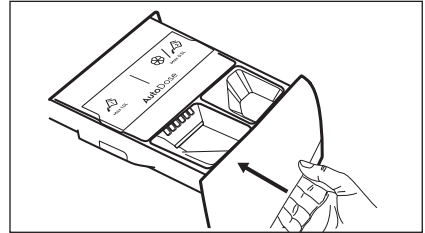

To restore the functionality, refill tanks with detergent and softener. If you place a wrong additives in the tanks, you can easily recover it by using the drain plug on both side of the drawer. Before opening drain plugs ensure to place a container below the drawer to collect the liquid. Ensure to properly close the plugs before refilling.

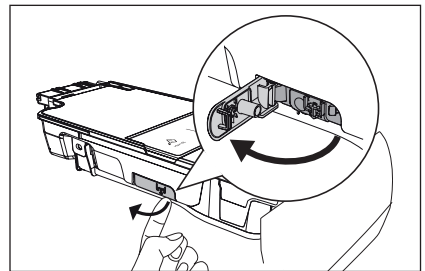

8.6 Cleaning The Pump



Regularly examine the drain pump and make sure that it is clean.

Clean the pump if:

- The appliance does not drain the water.
- The drum cannot turn.
- The appliance makes an unusual noise because of the blockage of the drain pump.
- The display shows an alarm code because of the problem with water drain.

! WARNING!

- Disconnect the mains plug from the mains socket.
- Do not remove the filter while the appliance is operating. Do not clean the drain pump if the water in the appliance is hot. The water must be cold before you clean the drain pump.

To clean the drain pump:

1. Open the drain pump door.

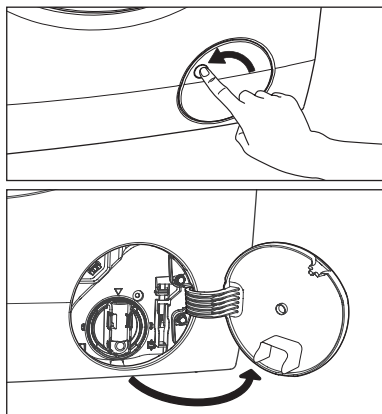

2. Place a suitable water container below the recess of the drain pump to collect the water that flows out.

Press the two levers and pull forward the drainage duct to let the water flow out.

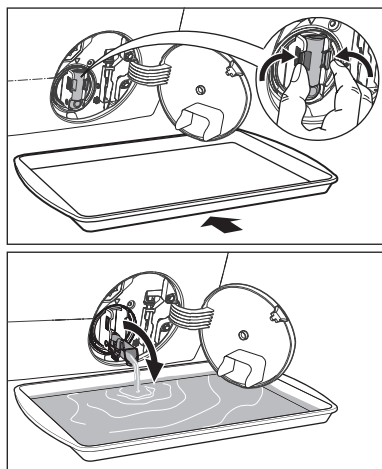

3. When the container is full of water, put the drainage duct back again and empty the container. Do step 2, 3 again and again until no more water flows out from the drain pump.

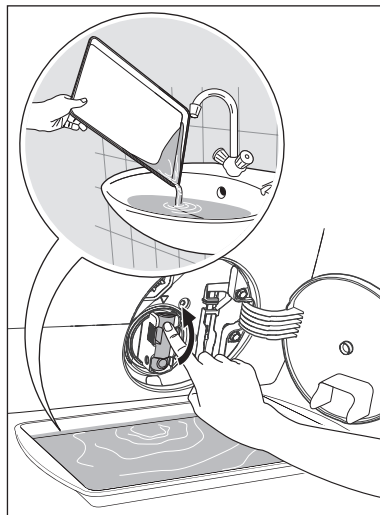

4. Push back the drainage duct and turn the filter counter-clockwise to remove it.

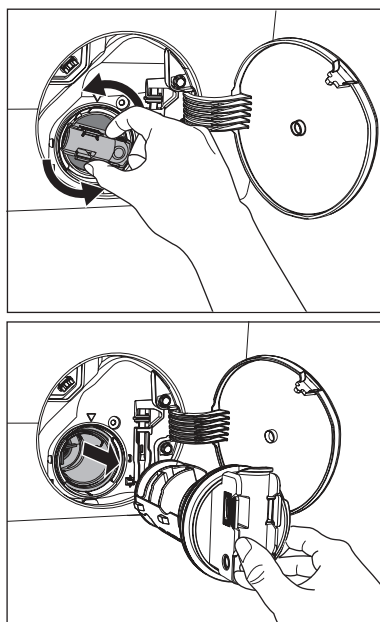

5. Remove fluff and objects from the pump (if there are any).

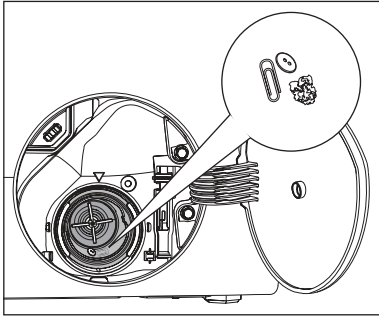

6. Make sure that the impeller of the pump can turn. If this does not occur, contact the service centre.

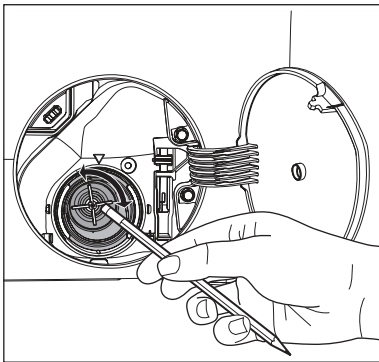

7. Clean the filter under the water tap.

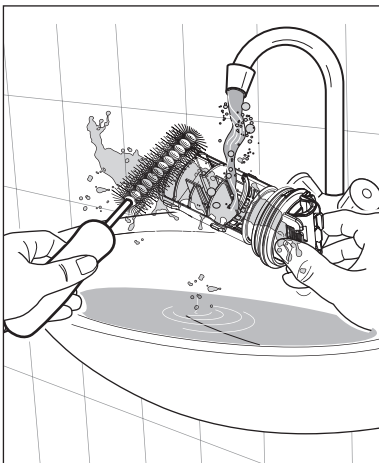

8. Put the filter back into the housing with exposed section facing up. Make sure that you correctly tighten the filter to prevent leakages.

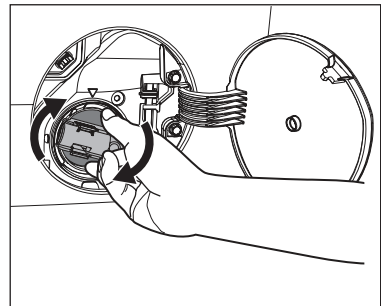
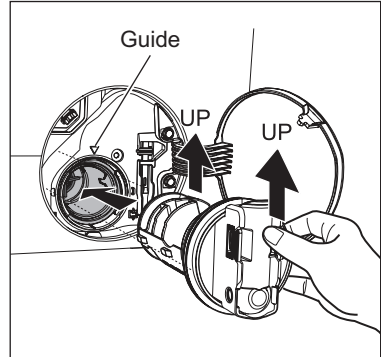

9. Close the drain pump door.

8.7 Cleaning The Water Inlet Filter

If your water is very hard or contains traces of lime deposit, the water inlet filter may become clogged. It is therefore a good idea to clean it from time to time.

To clean the water inlet filters:

1. Close the water tap.
2. Remove the water inlet hose from the water tap.

3. Clean the filter in the inlet hose with a stiff brush.

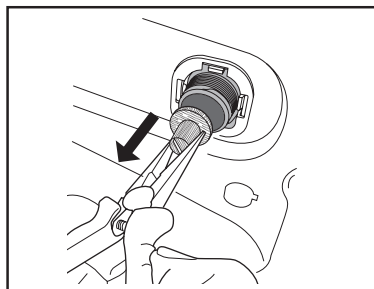
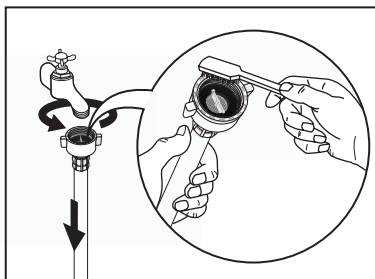

Clean the filter under the water tap.

4. Remove the inlet hose behind the appliance.

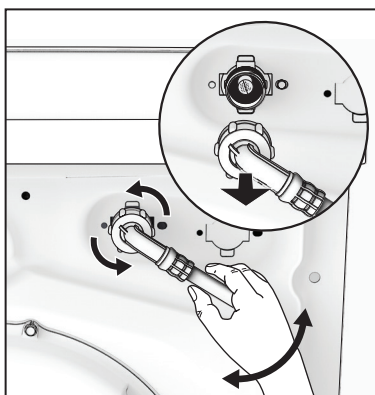

Install the valve filter back to the housing.

5. Use a suitable tool pulling filter from the valve (eg. long nose pliers) as picture.

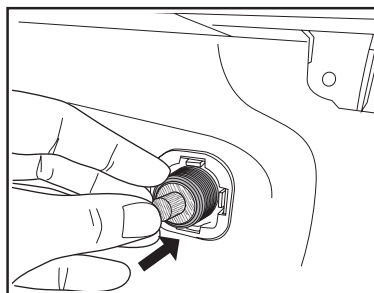
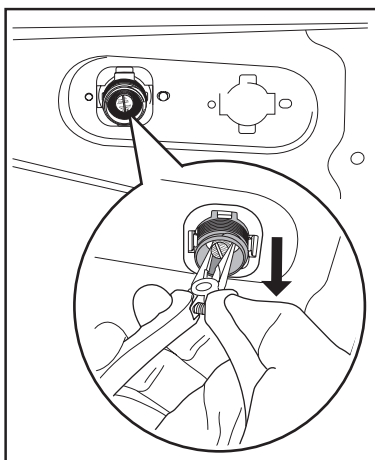

6. Install the inlet hoses again. Make sure that the couplings are tight to prevent leakages.
7. Open the water tap.

8.8 Frost Precautions

If the appliance is installed in an area where the temperature can be less than 0 °C, remove the remaining water from the inlet hose and the drain pump.

Emergency Drain

1. Disconnect the main plug from the main socket. Turn off the water tap.
2. Remove the water inlet hose.
3. Remove the drain hose from the rear support and unhook it from sink or spigot.

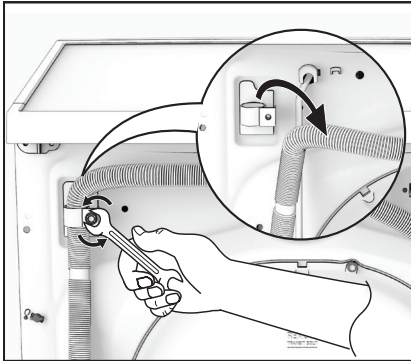

4. Put the end of the drain and inlet hose in a container. Let the water flow out of the hoses.

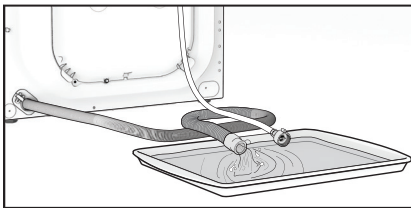

5. When no more water flows, install the inlet hose and the drain hose again.



NOTE

Make sure that the temperature is more than 0 °C before you use the appliance again.

9. TROUBLESHOOTING

9.1 Possible Failures

Certain problems are due to lack of simple maintenance or oversights, which can be solved easily without calling out an engineer. Before contacting your local Service Centre, please check troubleshooting.

Once the problem has been eliminated, press the Start/Pause button to restart the program. If after all checks, the problem persists, contact your local Service Centre.

 **WARNING!** Deactivate the appliance before you do the checks.

Malfunction	Possible cause	Alarm Code	Solution
Machine does not start:	The door has not been closed.	E 4 1	Close the door firmly.
	The plug is not properly inserted into the power socket.		Insert the plug into the power socket.
	There is no power at the socket.		Please check your domestic electrical installation.
	The Start/Pause touchpad has not been pressed.		Press the Start/Pause touchpad.
	The "Delay End" has been selected.		If the laundry are to be washed immediately, cancel the "Delay End".
	The Main supply is unstable.	E H 1 E H 2 E H 3	Wait until the main supply is stable. Appliance will start automatically.
	Sensing circuit of Autodosing faulty.	E C E	Switch off and switch on again. If still have the problem Call Service.
Machine does not fill the water:	The water tap is closed.	E 1 1	Open the water tap.
	The inlet hose is squashed or kinked.	E 1 1	Check the inlet hose connection.
	The filter in the inlet hose is blocked.	E 1 1	Clean the water inlet hose filter.
	The door is not properly closed.	E 4 1	Close the door firmly.
Machine fills then empties immediately:	The end of the drain hose is too low.	E 1 1	Refer to relevant paragraph in "water drainage" section.
Machine does not empty and/or does not spin:	The drain hose is squashed or kinked.	E 2 1	Check the drain hose connection.
	The drain pump is clogged.	E 2 1	Clean the drain pump filter.
	The option "Rinse Hold" has been selected.		Press Start/Pause touchpad to drain the water or select spin program.
	The laundry is not evenly distributed in the drum.		Pause the machine and redistribute laundry manually.

Malfunction	Possible cause	Alarm Code	Solution
There is water on the floor:	Water leaks from inlet hose fittings.		Check the water inlet hose connection.
	The drain hose is damaged.		Call Service.
	Too much detergent or unsuitable detergent (creates too much foam).	E F 2	Reset machine by switch off and switch on and select program "Rinse&Spin" to rinse foam. Next cycle should reduce detergent quantity (Adjust AutoDose page 22) and use correct type of detergent. (refer page 29)
	Water leaks inside the machine.	E F 3	Disconnect the main plug from the main socket. Close the water tab. Call Service.
Unsatisfactory washing results:	Too little detergent or unsuitable detergent has been used.		Increase detergent quantity (Adjust AutoDose page 22) or use different detergent. (refer page 29)
	Stubborn stains have not been treated prior to washing.		Use commercial products to treat the stubborn stains.
	The correct temperature was not selected.		Check if you have selected the correct temperature.
	Excessive laundry load.		Reduce load.
The door will not open:	The program is still running.		Wait until the end of cycle.
	There is water in the drum.		You must drain the water to open the door (refer "Opening The Door" on page 26.
	This problem may be caused by a failure of the appliance.		Contact Service. If you need to open the door, please read carefully "Emergency door opening" on page 41.
Machine vibrates or is noisy:	The transit bolts and packing have not been removed.		Check the correct installation of the appliance.
	The support feet have not been adjusted.		Check the correct levelling of the appliance.
	The laundry is not evenly distributed in the drum.		Pause the machine and redistribute laundry manually.
	There is very little laundry in the drum.		Load more laundry or reduce spin speed.
	Unstable floors eg. wooden floors.		Refer to relevant paragraph in "Positioning" section.

Malfunction	Possible cause	Alarm Code	Solution
There is water on the floor:	Detergent over dose.		Reduce the detergent quantity (Adjust AutoDose page 22) or use different detergent (Refer page 29 "Detergents Type And Quantity Of Detergent").
	Machine unbalance.		Redistribute laundry manually in the drum and start the spin phase again.
The cycle is shorter than the time displayed.	The appliance calculated a new time according to the laundry load.		
Spinning starts late or machine does not spin:	<p>The electronic unbalance detection device has cut in because the laundry is not evenly distributed in the drum. The laundry is redistributed by reverse rotation of the drum.</p> <p>This may happen several times before the unbalance disappears and normal spinning can resume. If, after 10 minutes, the laundry is still not evenly distributed in the drum, the machine will not spin. In this case, redistribute the load manually and select the spin program.</p>		Pause the machine and redistribute laundry manually.
Machine makes an unusual noise:	Machine not installed properly.		Make sure the levelling of the appliance is correct. Refer to "Installation".
	Transit bolts or packaging not removed.		Make sure that the packaging and/or the transit bolts are removed. Refer to "Unpacking".
	The load may be too small.		Add more laundry in the drum or reduce spin speed.
No water is visible in the drum:	Machines based on modern technology operate very economically using very little water without affecting performance.		
Remote function does not work:	Registration Data lost or damaged.	E RR	Restart machine by turn Off and turn On again. If problem not solved, please contact Service Centre.

i If you are unable to identify or solve the problem, contact our service centre.

Before calling service centre, make a note of the model, serial number and purchase date of your machine: the Service Centre will require this information.

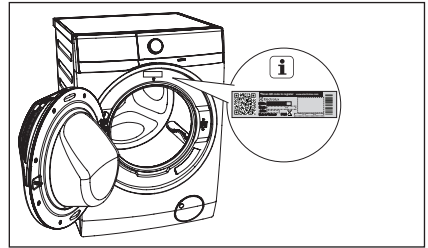

9.2 Emergency Door Opening

In case of power failure or appliance failure, the appliance door remains locked. The wash program continues when power is restored. If the door remains locked in case of failure, it is possible to open it using the emergency unlock feature.

Before opening the door:



WARNING!

Make sure that the water temperature and the laundry are not hot. Wait until they cool down if necessary.

Make sure that the water level inside the drum is not too high. If necessary, perform an Emergency Drain. (see page 37)

Make sure that the drum is not rotating. Wait until the drum stops rotating if necessary.

To open the door proceed as follows:

1. Press the On/Off button to switch the appliance off.
2. Disconnect the mains plug from the mains socket.
3. Open the filter cover.
4. Without touching the door. Insert a small flathead screw driver into the slot on emergency unlock strap (red strap) and pull down twice then pull the door open. Repeat if unsuccessful.

Note: Do not pull down emergency strap too hard.

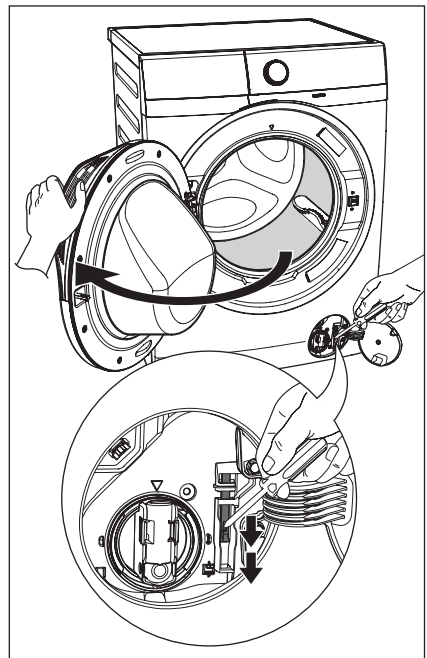

5. Take out the laundry.
6. Close the filter flap.

10. TECHNICAL DATA

Dimensions (Height / Width / Depth)		850 x 600 x 659 mm
Power supply (Voltage / Frequency)		220 - 240 V~ / 50 Hz
Total power absorbed		2000 W
Water supply pressure (Maximum / Minimum)		0.8 MPa / 0.05 MPa
Maximum dry clothes capacity	Program	Max. Capacity
	Cottons	10 kg
	Mixed	4 kg
	Delicates	4 kg
	Bedding	3 kg
	Vapour Refresh	1.5 kg
	Energy Saver	10 kg
	App Program	-
	Spin	10 kg
	Rinse + Spin	10 kg
	Sports	4 kg
	Wool 	2 kg
	Quick 15	1.5 kg
Daily 39	5.5 kg	
Full Wash 60	10 kg	
Favourite	-	
Spin speed (Maximum / Minimum)		1400 rpm / 400 rpm

11. INSTALLATION

11.1 Unpacking

CAUTION!

All transit bolts and packing must be removed before using the appliance.

You are advised to keep all transit devices so that they can be refitted if the machine ever has to be transported again.

1. Use gloves. Remove the external film. If necessary, use a cutter.

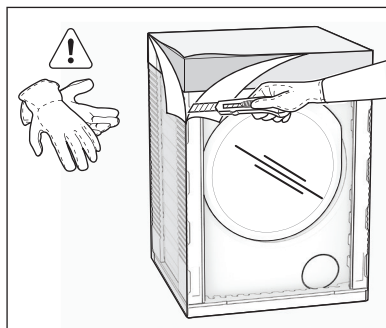

2. Remove the cardboard top.
3. Remove the polystyrene packaging materials.
4. Remove the plastic bag which cover the machine.

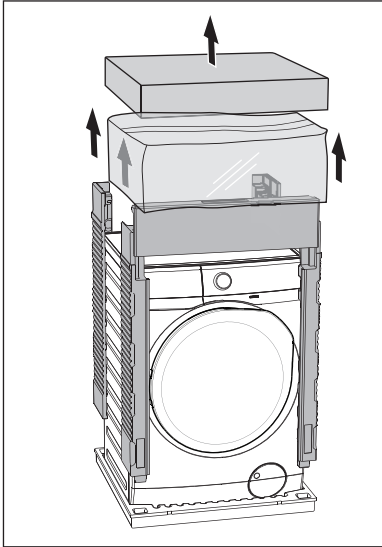

5. Open the door. Remove all the items from the drum.

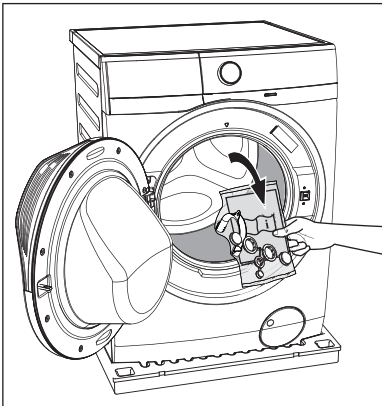

6. Put one of the polystyrene packaging elements on the floor behind the appliance. Carefully put down the appliance with the rear side on it. Make sure not to damage the hoses.

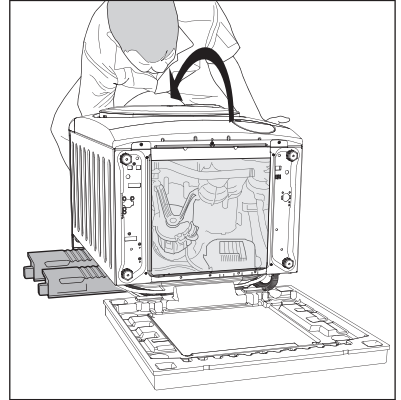

7. Remove the polystyrene base.

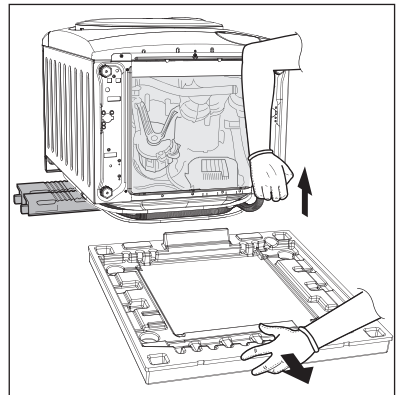

8. Pull up the appliance in vertical position.
9. Remove the power supply cable and the drain and inlet hoses from the hose holders (A) on the rear of the appliance.

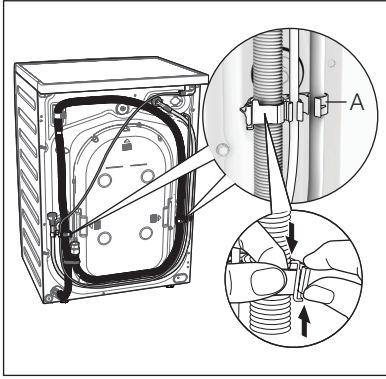

- 10. Remove the three transit bolts.
- 11. Pull out the plastic spacers.

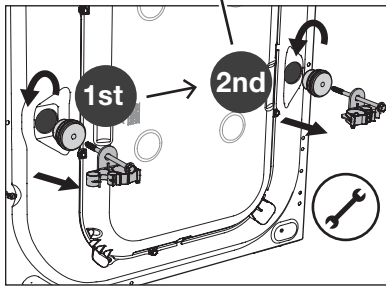
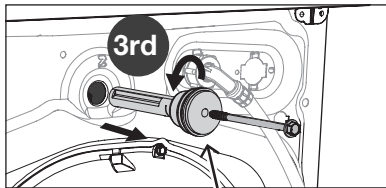
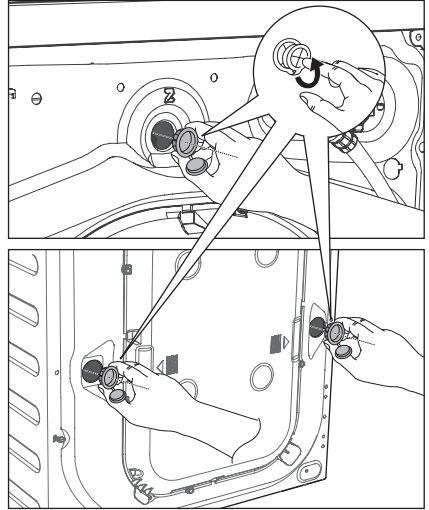

- 12. Put the plastic caps in the holes (X3). You can find these caps in the user manual bag.

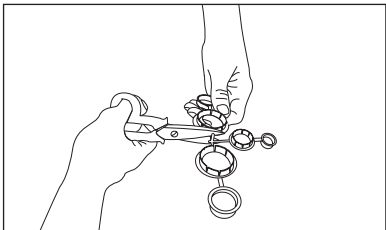

11.2 Positioning

It is important that your machine stands firm and leveled on the floor to ensure correct operation. The appliance must not be installed behind a lockable door, a sliding door or a door with a hinge on the opposite side to avoid restricting the machine door.

Use a spirit level on the top and side of the machine to check the levels.

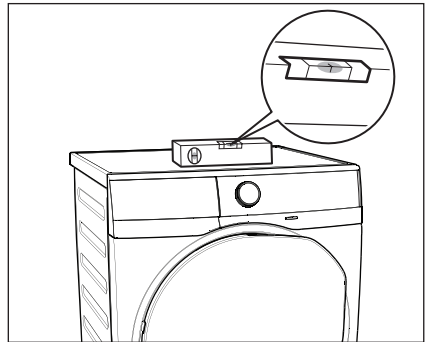

If you do not have a spirit level, as a guide use the edge of a door frame, cupboard or bench to check that the machine is leveled.

Loosen or tighten the feet to adjust the level. A correct adjustment of the appliance level prevents vibration, noise and the movement of the appliance when in operation.

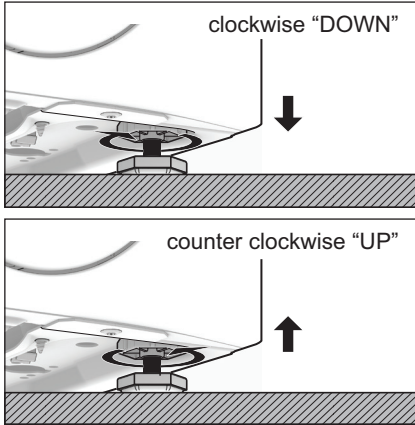

When the washing machine is levelled, try to rock it from corner to corner. If it does rock, adjust the legs again until it is levelled and does not rock.

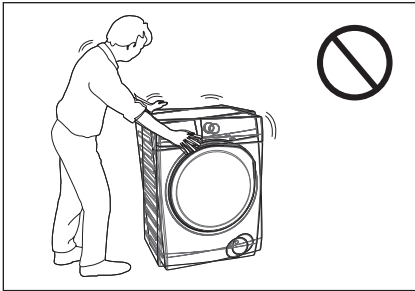

Never place cardboard, wood or similar materials under the machine to compensate for any unevenness in the floor. Install the machine on a flat hard floor. Make sure that air circulation around the machine is not impeded by carpets, rugs etc.

Check that the machine does not touch the wall or cupboard units.

11.3 Water Inlet

Connect the water inlet hose to a tap with 3/4" BSP thread.

Use the hose supplied with the washing machine. **DO NOT USE OLD HOSES.**

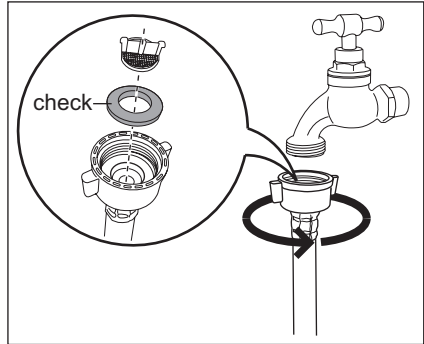

The inlet hose must not be lengthened. If it is too short and you do not wish to move the tap, you will have to purchase a new, longer hose specially designed for this type of use.

Loosen the ring nut to angle the hose to the left or right depending on the position of your water tap. Do not place the inlet hose downwards. After positioning the inlet hose, be sure to tighten the ring nut again to prevent leaks.

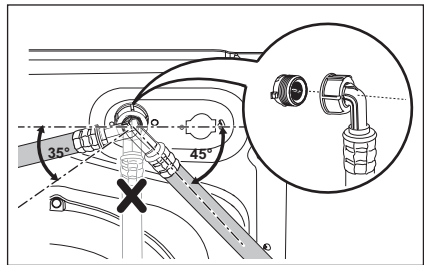

11.4 Water Drainage

The end of the drain hose can be positioned in three ways:

- **Hooked over the edge of a sink**, using the plastic hose guide supplied with the machine.

Fitting Hose Guide

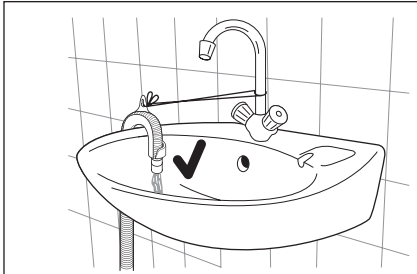
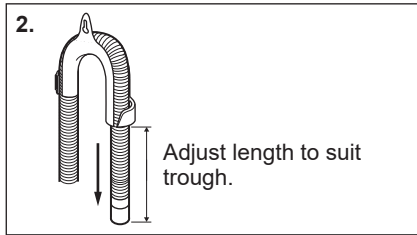
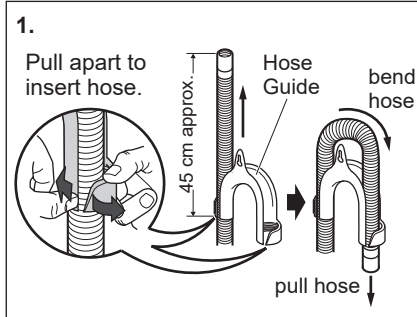

In this case, make sure the end cannot come unhooked when the machine will be emptied. This could be done by tying it to the tap with a piece of string or attaching it to the wall.

- **In a sink, drain pipe branch.**

This branch must be above the trap so that the bend is at least 60 cm above the ground.

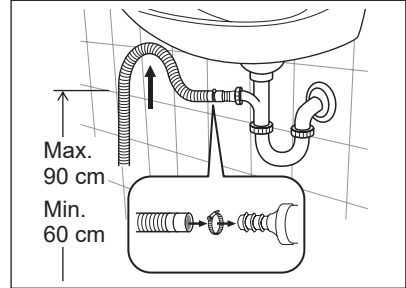

Push the drain hose onto the spigot and secure with a clamp, ensure a loop is formed in the drain hose to prevent waste from the sink entering the appliance.

- **Directly into a drain pipe, at a height of not less than 60 cm and not more than 90 cm.**

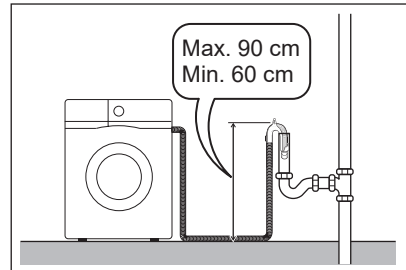

The end of the drain hose must always be ventilated, i.e. the inside diameter of the drain pipe must be larger than the outside diameter of the drain hose.

The drain hose must not be twisted or curled. Run it along the floor; only the part near the drainage point must be raised.

For the correct functioning of the machine, the drain hose must remain hooked on the proper support piece situated on the top part of back side of the appliance.

11.5 Electrical Connection

This machine is designed to operate on a 220-240 V, single-phase, 50 Hz supply.

“An incorrect power supply may void your warranty.”

Check that your domestic electrical installation can take the maximum load required (2.0 kW), also taking into account any other appliances in use.



CAUTION!

Connect the machine to an earthed socket outlet.



The manufacturer declines any responsibility for damage or injury through failure to comply with the above safety precaution.



Should the appliance power supply cable need to be replaced, this shall be carried out by our Service Centre.

When the appliance is installed, the power supply cable must be easily accessible.

12. ENVIRONMENT CONCERNS

12.1 Packaging Materials



The materials marked with the symbol  are recyclable.

>PE<=polyethylene

>PS<=polystyrene

>PP<=polypropylene

This means that they can be recycled by disposing them properly in appropriate collection containers.

12.2 Old Machine

Use authorized disposal sites for your old appliance. Help to keep your country tidy!

The symbol  on the product or on its packaging indicates that this product may not be treated as household waste.

Instead it shall be handed over to the applicable collection point for the recycling of electrical and electronic equipment. By ensuring this product is disposed of correctly, you will help prevent potential negative consequences for the environment and human health, which could otherwise be caused by inappropriate waste handling of this product.

For more detailed information about recycling of this product, please contact your local city office, your household waste disposal service or the shop where you purchased the product.

12.3 Ecological Hints

To save water, energy and to help protect the environment, we recommend that you follow these tips:

- Normally soiled laundry may be washed without prewashing in order to save detergent, water and time (the environment is protected too!).
- The machine works more economically if it is fully loaded.
- With adequate pre-treatment, stains and limited soiling can be removed; the laundry can then be washed at a lower temperature.
- Measure out detergent according to the water hardness, the degree of soiling and the quantity of laundry being washed.

13. WI-FI CONNECTIVITY SETUP

i “The software in this product contains components that are based on free and open source software. Electrolux gratefully acknowledges the contributions of the open software and robotics communities to the development project. To access the source code of these free and open source software components whose license conditions require publishing, and to see their full copyright information and applicable license terms, please visit:

<http://electrolux.opensourcerepository.com>”

This chapter describes how to connect the smart appliance to the Wi-Fi network and to link it to a mobile devices.

By this functionality you can monitor and control your laundry appliance from your mobile devices.

To connect the appliance to enjoy the full range of features and services you need:

- Wireless network at home with internet connection enabled.
- Mobile device connected to wireless network.

Frequency	2.4 GHz according to local country regulation
Protocol	IEEE 802.11b/g/n
Max Power	According to local country regulation





13.1 Download and installing and configuring “Electrolux Life” App*.

1. Go to the App Store/Play Store on your smart device.



2. Download and install App  “Electrolux Life”.

* Minimum requirements: iPhone6/iOS 9.3/ Android 5.1 and above. You will need to install the Electrolux Life App, create an Electrolux account and accept the Terms and Conditions and Electrolux’s Privacy Policy in the App to use the connected features of the laundry appliance. Internet and Wi-Fi connections are required to use the full features of the App and the laundry appliance. Minimum requirements, Apps and services are subject to change without notice.

3. Create an Electrolux account. You can only create one Electrolux account per product. This account can be shared across multiple devices.
4. Setting up your Washing Machine. Make sure your machine is plugged in and operating normally, stand near it with your smart device. Tap on “Appliances” at the bottom of the home screen. Tap on “Add Appliance” and follow the prompts on screen. * Setup will take several minutes depending on your network speed.
5. Turning on your Washing Machine Wi-Fi. Initially your machine creates its own Wi-Fi network to assist in setting up. After setup this network disappears and your machine will connect to your home Wi-Fi network. Press and hold  Remote touch button for 3 seconds. The text  pop up for about 5 seconds and the icon  starts flashing and wireless module begins starting up. It may takes about 45 seconds before it is ready. When the wireless module is ready, the text  (Access Point) is on to inform you, that the access point will be open for about 3 minute.
6. Connect your Washing Machine: **iOS** Tap the home button to exit the app. Go to “Settings” on your phone and select “Wi-Fi”. Select your Washing Machine’s Wi-Fi

network. It is the one that begins with “@E_” (it may take a few moments to appear). Tap the home button to exit your phone settings and then return to the Electrolux Life App.

Wait for confirmation of connection which may take up to a minute before proceeding to the next step.



i For iOS devices, you will then be prompted go to “SETTINGS” on your phone and select your Home Wi-Fi, then return to the Electrolux Life App.

Android

For Android devices, select your Washing Machine’s Wi-Fi network from the drop-down box.

7. Connect your Washing Machine to your home Wi-Fi.

You’ll need to select your Wi-Fi network name and input your password.

If the connectivity is configured,  (Access Point) symbol is off and the icon  will stop blinking and lit steadily to confirm that the configuration was successful Connection success!

i Every time you switch the Washing Machine on, the machine takes 45 seconds to connect to the network automatically. When the  indicator stops blinking the connection is ready.



Please proceed to the next screen to register the Washing Machine.

8. Product registration; Simply add your Washing Machine’s name and the purchase date.



Congratulations!

Now you’re all set up. You can start exploring the Electrolux Life App.

To switch the wireless connection off,

Press and hold  Remote touch button for 3 seconds until the first acoustic signal:  appears on the display.

To remove the wireless credentials,

Press and hold  Remote touch button for 10 seconds until the second acoustic signal:  appears on the display.



i If you switch the machine off and on again, the wireless connection is automatically off.

13.2 Remote Start



When the App is installed and the wireless connection is complete, you can start and stop a program remotely by activate remote start.

i The Remote Control activates automatically when you press the Start/Pause button to start the program, but it is also possible to start a program.

Activate Remote Start

1. Press the  Remote button and the indicator  appears on the display.
2. Press the Start/Pause button to activate the Remote Start. Now it is possible to start the program remotely.

Deactivate Remote Start

Press the  Remote touch button. The  icon is off and the remote start is deactivated.

i If the door is unlock, the Remote Start is deactivated.

13.3 Over-the-air update

The App may propose an update for downloading new features.

The update is accepted via App only.

If a programme is running, the App notifies that the update will start at the end of the programme.

During the update, the appliance shows  in the display.

The appliance will usable again at the end of the update, without any notification about successful update.

If an error occurs, the appliance shows  in the display: just press any buttons or turn the knob to return to normal use.

NOTE

Electrolux Warranty

FOR SALES IN AUSTRALIA AND NEW ZEALAND

APPLIANCE: ELECTROLUX WASHING MACHINES & WASHER/DRYERS

This document sets out the terms and conditions of the product warranties for Electrolux Appliances. It is an important document. Please keep it with your proof of purchase documents in a safe place for future reference should there be a manufacturing defect in your Appliance. This warranty is in addition to other rights you may have under the Australian Consumer Law.

1. In this warranty:

- 'ACL' or 'Australian Consumer Law' means Schedule 2 to the Competition and Consumer Act 2010;
- 'Appliance' means any Electrolux product purchased by you and accompanied by this document;
- 'ASC' means Electrolux's authorised serviced centres;
- 'Electrolux' is the brand controlled by Electrolux Home Products Pty Ltd of 163 O'Riordan Street, Mascot NSW 2020, ABN 51 004 762 341 in respect of Appliances purchased in Australia and Electrolux (NZ) Limited (collectively "Electrolux") of 3-5 Niall Burgess Road, Mount Wellington, in respect of Appliances purchased in New Zealand;
- 'Warranty Period' means the period specified in clause 3 of this warranty;
- 'you' means the purchaser of the Appliance not having purchased the Appliance for re-sale, and 'your' has a corresponding meaning.

2. Application: This warranty only applies to new Appliances, purchased and used in Australia or New Zealand and is in addition to (and does not exclude, restrict, or modify in any way) other rights and remedies under a law to which the Appliances or services relate, including any non-excludable statutory guarantees in Australia and New Zealand.

3. Warranty Period: Subject to these terms and conditions, this warranty continues for in Australia for a period of 24 months and in New Zealand for a period of 24 months following the date of original purchase of the Appliance.

- Inverter motor – Further 8 years

4. Repair or replace warranty: During the Warranty Period, Electrolux or its ASC will, at no extra charge if your Appliance is readily accessible for service, without special equipment and subject to these terms and conditions, repair or replace any parts which it considers to be defective. Electrolux may, in its absolute discretion, choose whether the remedy offered for a valid warranty claim is repair or replacement. Electrolux or its ASC may use refurbished parts to repair your Appliance. You agree that any replaced Appliances or parts become the property of Electrolux.

5. Travel and transportation costs: Subject to clause 7, Electrolux will bear the reasonable cost of transportation, travel and delivery of the Appliance to and from Electrolux or its ASC. Travel and transportation will be arranged by Electrolux as part of any valid warranty claim.

6. Proof of purchase is required before you can make a claim under this warranty.

7. Exclusions: You may not make a claim under this warranty unless the defect claimed is due to faulty or defective parts or workmanship. This warranty does not cover:

- light globes, batteries, filters or similar perishable parts;
- parts and Appliances not supplied by Electrolux;
- cosmetic damage which does not affect the operation of the Appliance;

- damage to the Appliance caused by:
 - negligence or accident;
 - misuse or abuse, including failure to properly maintain or service;
 - improper, negligent or faulty servicing or repair works done by anyone other than an Electrolux authorised repairer or ASC;
 - normal wear and tear;
 - power surges, electrical storm damage or incorrect power supply;
 - incomplete or improper installation;
 - incorrect, improper or inappropriate operation;
 - insect or vermin infestation;
 - failure to comply with any additional instructions supplied with the Appliance;

In addition, Electrolux is not liable under this warranty if:

- The Appliance has been, or Electrolux reasonably believes that the Appliance has been, used for purposes other than those for which the Appliance was intended, including where the Appliance has been used for any non-domestic purpose;
- The Appliance is modified without authority from Electrolux in writing;
- The Appliance's serial number or warranty seal has been removed or defaced.

8. How to claim under this warranty: To enquire about claiming under this warranty, please follow these steps:

- carefully check the operating instructions, user manual and the terms of this warranty;
- have the model and serial number of the Appliance available;
- have the proof of purchase (e.g. an invoice) available;
- telephone the numbers shown below.

9. Australia: For Appliances and services provided by Electrolux in Australia: Electrolux goods come with guarantees that cannot be excluded under the Australian Consumer Law. You are entitled to a replacement or refund for a major failure and for compensation for any other reasonably foreseeable loss or damage. You are also entitled to have the Appliance repaired or replaced if the Appliance fails to be of acceptable quality and the failure does not amount to a major failure. 'Acceptable quality' and 'major failure' have the same meaning as referred to in the ACL.

10. New Zealand: For Appliances and services provided by Electrolux in New Zealand, the Appliances come with a guarantee by Electrolux pursuant to the provisions of the Consumer Guarantees Act, the Sale of Goods Act and the Fair Trading Act. Where the Appliance was purchased in New Zealand for commercial purposes the Consumer Guarantee Act does not apply.

11. Confidentiality: You accept that if you make a warranty claim, Electrolux and its agents including ASC may exchange information in relation to you to enable Electrolux to meet its obligations under this warranty. For more information on how we handle your personal information, see our privacy policy at www.electrolux.com.au/other/privacy/ or www.electrolux.co.nz/other/privacy/

Important Notice

Before calling for service, please ensure that the steps listed in clause 8 above have been followed.

<p>FOR SERVICE or to find the address of your nearest authorised service centre in Australia PLEASE CALL 13 13 49 <small>For the cost of a local call (Australia only)</small></p>	<p>AUSTRALIA ELECTROLUX HOME PRODUCTS 163 O'Riordan Street, Mascot NSW 2020 electrolux.com.au</p>	<p>FOR SPARE PARTS IN AUSTRALIA please visit shop.electrolux.com.au or call 13 13 50 <small>For the cost of a local call (Australia only)</small></p>
<p>FOR SERVICE or to find the address of your nearest authorised service centre in New Zealand PLEASE CALL 0800 10 66 10 <small>(New Zealand only)</small></p>	<p>NEW ZEALAND ELECTROLUX (NZ) Limited 3-5 Niall Burgess Road, Mount Wellington electrolux.co.nz</p>	<p>FOR SPARE PARTS IN NEW ZEALAND or to find the address of your nearest spare parts centre in New Zealand PLEASE CALL 0800 10 66 20 <small>(New Zealand only)</small></p>

www.electrolux.com



G0042539-001-A20692125