

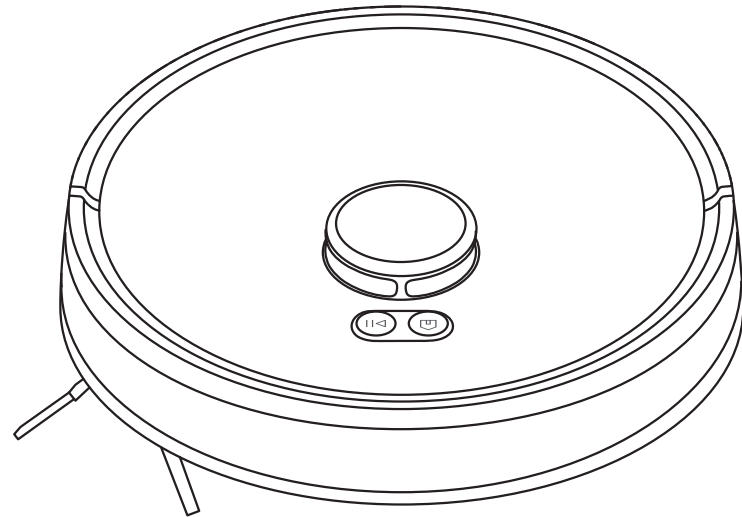

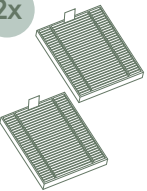

EFR71222DS

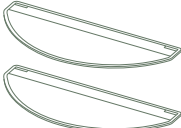
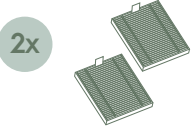

 [electrolux.com/shop](https://electrolux.com/shop)

<p>2x</p>  <p><b>Filter Kit</b> Ref: EFR4 PNC: 900 923 683</p>	<p>2x</p>  <p><b>Mopping Pads</b> Ref: EMR2 PNC: 900 923 686</p>	<p>2x</p>  <p>2x</p>  <p>2x</p>  <p>1x</p>  <p><b>Robotic peak performance kit</b> Ref: ERK6 PNC: 900 923 687</p>
---	---	---

4x



**S-bag**  
Ref: E201S  
PNC: 900 168 458

The software in the robot is partly based on free and open source software. To access the source code of these components and to see the full copyright information and applicable license terms, please visit:  
[www.electrolux.com/rvc-supplementary](https://www.electrolux.com/rvc-supplementary)



