



**Enjoy peace of mind.  
Register your appliance today.**

Stay updated on better living services,  
safety notices and shop for accessories.

- 1. Open the camera app  
on your smartphone  
and point at the QR  
code to scan.**

Product Registration QR code  
is located on the top surface  
or underside of your appliance.

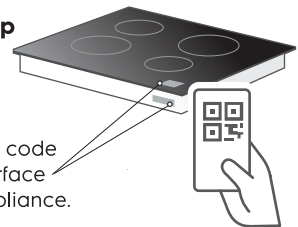

- 2. Tap the notification or link to open the  
registration form.**

- 3. Complete your details and enjoy peace  
of mind.**

# CONGRATULATIONS

Dear customer,

Congratulations on the purchase of your new cooktop.

Before you use the cooktop, we recommend that you read through the whole user manual which provides the description of the cooktop and its functions.

To avoid the risks that are always present when you use an electrical appliance, it is important that the cooktop is installed correctly and that you read the safety instructions carefully to avoid misuse and hazards.

We recommend that you keep this instruction booklet for future reference and pass it on to any future owners.

After unpacking the appliance, please check it is not damaged. If in doubt, do not use the appliance but contact your local Customer Care Centre.

For contact details, refer to the last page of this user manual. This appliance complies with requirements of Australian Standard AS/NZS 60335.2.6

### Conditions of use

This appliance is intended to be used in household and similar applications such as:

- Staff kitchen areas in shops, offices and other working environments
- Farm houses
- By clients in hotels, motels and other residential type environments
- Bed and breakfast type environments

**Please ensure you read the instruction manual fully before you call for service, or a full service fee could be applicable.**

Record model and serial number here:

Model number: \_\_\_\_\_

Serial number: \_\_\_\_\_

PNC: \_\_\_\_\_

# CONTENTS

Important safety instructions \_\_\_\_\_ 3

Installation instructions \_\_\_\_\_ 5

Product description \_\_\_\_\_ 7

Operating instructions \_\_\_\_\_ 9

Helpful hints and tips \_\_\_\_\_ 11

Care and cleaning \_\_\_\_\_ 12

Troubleshooting... \_\_\_\_\_ 13

Warranty \_\_\_\_\_ 15

Please read the user manual carefully and store in a handy place for later reference.

The symbols you will see in this booklet have these meanings:



**This symbol indicates information concerning your personal safety.**



**This symbol indicates information on how to avoid damaging the appliance.**



**This symbol indicates tips and information about use of the appliance.**



**This symbol indicates tips and information about economical and ecological use of the appliance.**

### Important Information that may impact your Manufacturer's Warranty

Adherence to the directions for use in this manual is extremely important for health and safety. Failure to strictly adhere to the requirements in this manual may result in personal injury, property damage and affect your ability to make a claim under the Electrolux manufacturer's warranty provided with your product. Products must be used, installed and operated in accordance with this manual. You may not be able to claim on the Electrolux manufacturer's warranty in the event that your product fault is due to failure to adhere this manual.

# IMPORTANT SAFETY INSTRUCTIONS



## IMPORTANT

### Check for any damage or marks

If you find the cooktop is damaged or marked, you must report it within 7 days if you wish to claim for damage/ marks under the manufacturer's warranty. This does not affect your statutory rights.



## ENVIRONMENT

### Information on disposal for users

- All of the packaging materials are recyclable. Please dispose of those materials through your local recycling depot or by placing them in appropriate collection containers.
- If you wish to discard this product, please contact your local authorities and ask for the correct method of disposal.



## WARNING

### Risk of suffocation, injury or permanent disability.

- Do not let persons, children included, with reduced physical sensory, reduced mental functions or lack of experience and knowledge use the appliance. They must have supervision or instruction for the operation of the appliance by a person who is responsible for their safety.
- Do not let children play with the appliance.
- Keep all packaging away from children.
- Keep children and pets away from the appliance when it operates or when it cools down. Accessible parts are hot.
- If the appliance has a child safety device, we recommend that you activate it.

## INSTALLATION



## WARNING

### Only a qualified person must install this appliance.

- Remove all the packaging.
- Do not install or use a damaged appliance.
- Obey the installation instruction supplied with the appliance.
- Keep the minimum distance from the other appliances and units.
- Always be careful when you move the appliance because it is heavy. Always wear safety gloves.
- Seal the cut surfaces with a sealant to prevent moisture to cause swelling.

- Protect the bottom of the appliance from steam and moisture.
- Do not install the appliance adjacent to a door or under a window. This prevents hot cookware to fall from the appliance when the door or the window is opened.
- If the appliance is installed above drawers make sure that the space, between the bottom of the appliance and the upper drawer, is sufficient for air circulation.
- Make sure that the ventilation space of 5 mm, between the worktop and the front of the below unit, is free. The warranty does not cover damages caused by the lack of an adequate ventilation space.
- The bottom of the appliance can get hot. We recommend to install a non-combustible separation panel under the appliance to prevent access to the bottom.

## ELECTRICAL CONNECTION



## WARNING

### Risk of fire and electrical shock.

- All electrical connections must be made by a qualified electrician. Before wiring make sure the mains terminal is not live.
- Make sure the appliance is installed correctly. Loose and incorrect plug and socket connections can make the terminal become too hot.
- The appliance must be installed correctly to ensure anti-shock protection.
- Cables from other electrical appliances must not touch the hot surface of the appliance.
- Other than the connection point in the terminal block, do not let the electrical supply cord touch the appliance or hot cookware. Ensure electrical supply cord is not tangled.
- Use a strain relief clamp on cable.
- Use the correct mains cable.
- Make sure there is no damage to the mains plug and to the mains cable. Contact the Service or an electrician to change a damaged mains cable.
- The electrical installation must have an isolation device which lets you disconnect the appliance from the mains at all poles. The isolation device must have a contact opening width of minimum 3mm.
- Use only correct isolation devices: line protecting cut-outs, fuses (screw type fuses removed from the holder), earth leakage trips and contactors.

# IMPORTANT SAFETY INSTRUCTIONS (CONTINUED)

## OPERATION



### WARNING

#### Risk of injury, burns or electric shock.

- Use this appliance in a household environment.
- Do not change the specification of this appliance.
- Do not use an external timer or a separate remote-control system to operate the appliance.
- Do not let the appliance stay unattended during operation.
- Do not operate the appliance with wet hands or when it has contact with water.
- Do not put cutlery or saucepan lids on the cooking zones. They can become hot.
- Set the cooking zone to “off” after each use. Do not rely on the pan detector.
- Do not use the appliance as a work surface or as a storage surface.
- If there is a crack on the surface, disconnect power supply to prevent the electrical shock.
- Users with a pacemaker must keep a distance of minimum 30 cm from the induction cooking zones when the appliance is in operation.



### WARNING

#### Risk of fire or explosion.

- Fats and oil when heated can release flammable vapours. Keep flames or heated objects away from fats and oils when you cook with them.
- The vapours that very hot oil releases can cause spontaneous combustion.
- Used oil, that can contain food remnants, can cause fire at a lower temperature than oil used for the first time.
- Do not put flammable products or items that are wet with flammable products in, near or on the appliance.
- Do not try to extinguish a fire with water. Disconnect the appliance and cover the flame with a lid or a fire blanket.



### WARNING

#### Risk of damage to the appliance.

- Do not keep hot cookware on the control panel.
- Do not let cookware to boil dry.
- Be careful not to drop utensils or cookware on the glass, the glass surface can be damaged
- Do not activate the cooking zones with empty cookware or without cookware.
- Do not put aluminium foil on the appliance.
- Cookware made of cast iron, aluminium or with a damaged bottom can cause scratches on the glass ceramic. Always lift these objects up when you have to move them on the cooking surface.

## CARE AND CLEANING



### WARNING

#### Risk of damage to the appliance.

- Regularly clean the appliance to prevent deterioration of the surface material.
- Do not use water spray and steam to clean the appliance.
- Clean the appliance with a moist soft cloth. Only use neutral detergents. Do not use abrasive products, abrasive cleaning pads, solvents or metal objects.

# INSTALLATION INSTRUCTIONS

## Built-in appliances

- Only use the built-in appliances after you assemble the appliance into correct built-in units and work surfaces that align to the standards.

## To attach the seal

- Clean the worktop in the area of the cut out section.
- Bond the seal stripe supplied on the lower edge of the appliance along the outer edge of the glass ceramic. Do not extend it. Let stay the cut ends in the middle of one side. When, you cut it to length (add some mm), push the two ends together.

## Connection cable

- Use the correct mains cable of type H05BB-F Tmax 90°C (or higher) for a single phase or two phase connection.
- Replace the damaged mains cable with a special cable (type H05BB-F Tmax 90°C or higher). 3 x 2.5mm<sup>2</sup> with an all-pole 25A breaker. Speak to your local Service Centre.
- The earth cord (green/yellow/cable) must be 2cm longer than phase and neutral cable (blue and brown cables).
- The cable conditions must be in accordance with regulations and the terminal screws tightened securely.
- The connecting cable is to be secured with the mains cable cleat and the covering closed by pressing firmly (lock into place).
- Before switching on for the first time, any protective foil or stickers must be removed from the glass ceramic surface.

## Assembly

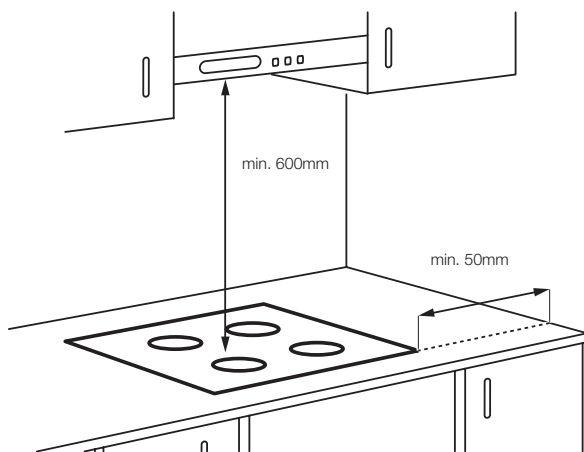

**NOTE:** The clearance must meet or exceed the minimum recommended for both the rangehood and cooktop. Refer to the rangehood installation manual.



## IMPORTANT

Before the installation, note down the serial number (Ser. Nr.) from the rating plate. The rating plate of the appliance is on its lower casing.



## WARNING

Refer to "Safety information" chapter.

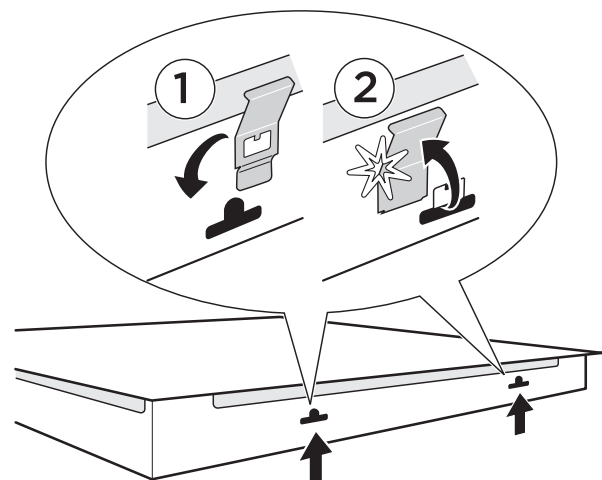
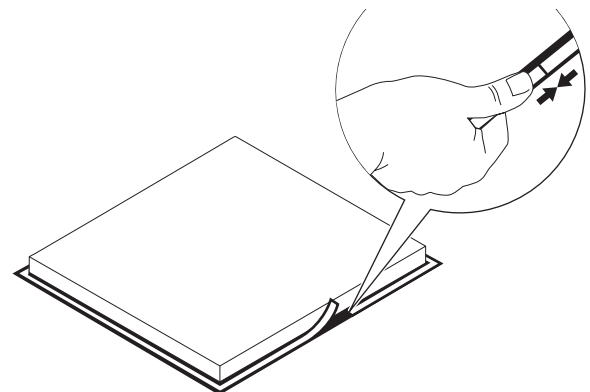

# INSTALLATION INSTRUCTIONS (CONTINUED)

## EH1321BEA/EH1321BFA

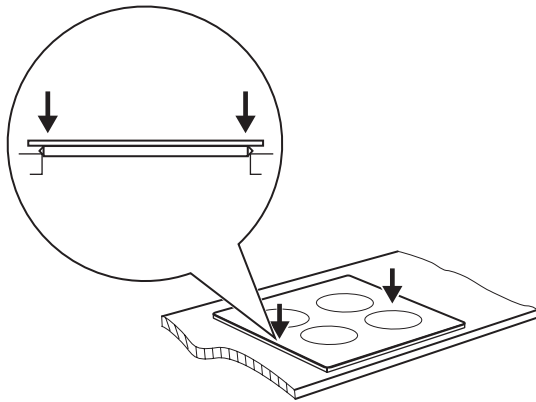
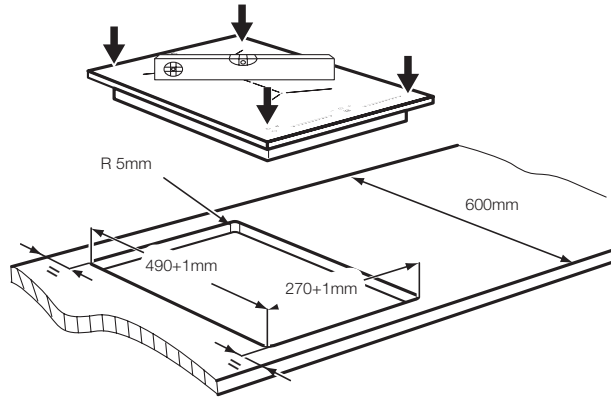

### Technical data

EH1321BEA/EH1321BFA	
PNC	949163498/949163526
Product dimensions (w x d) mm	300 x 520
Cut-out dimensions (w x d) mm	270 x 490
Voltage (volts)	220-240
Cycles (Hz)	50-60
Total power	3700
Elements (Watts)	2
Front (Watts)	1400/2500
Rear (Watts)	2300/ 3200

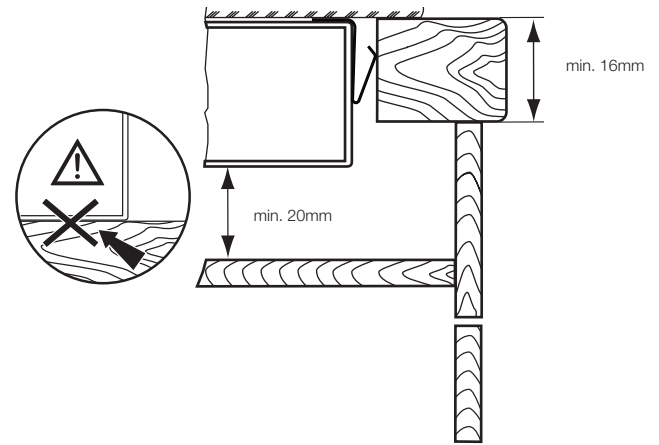

### **i** IMPORTANT

It is recommended to centre the bench cutout with equal distance front and back as shown but the product has also been certified to be installed with no clearance between the rear edge of the cooktop glass and rear wall if required. In doing so, installers still need to leave sufficient clearance to take into account that the glass dimensions are larger than the cut out.

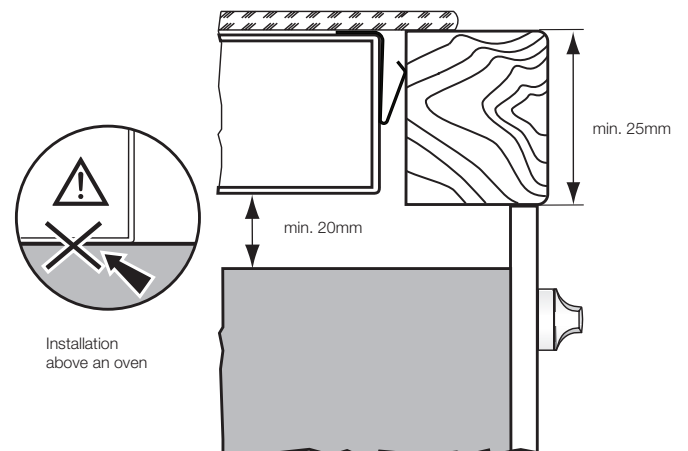

# PRODUCT DESCRIPTION

## EHI321BEA/EHI321BFA

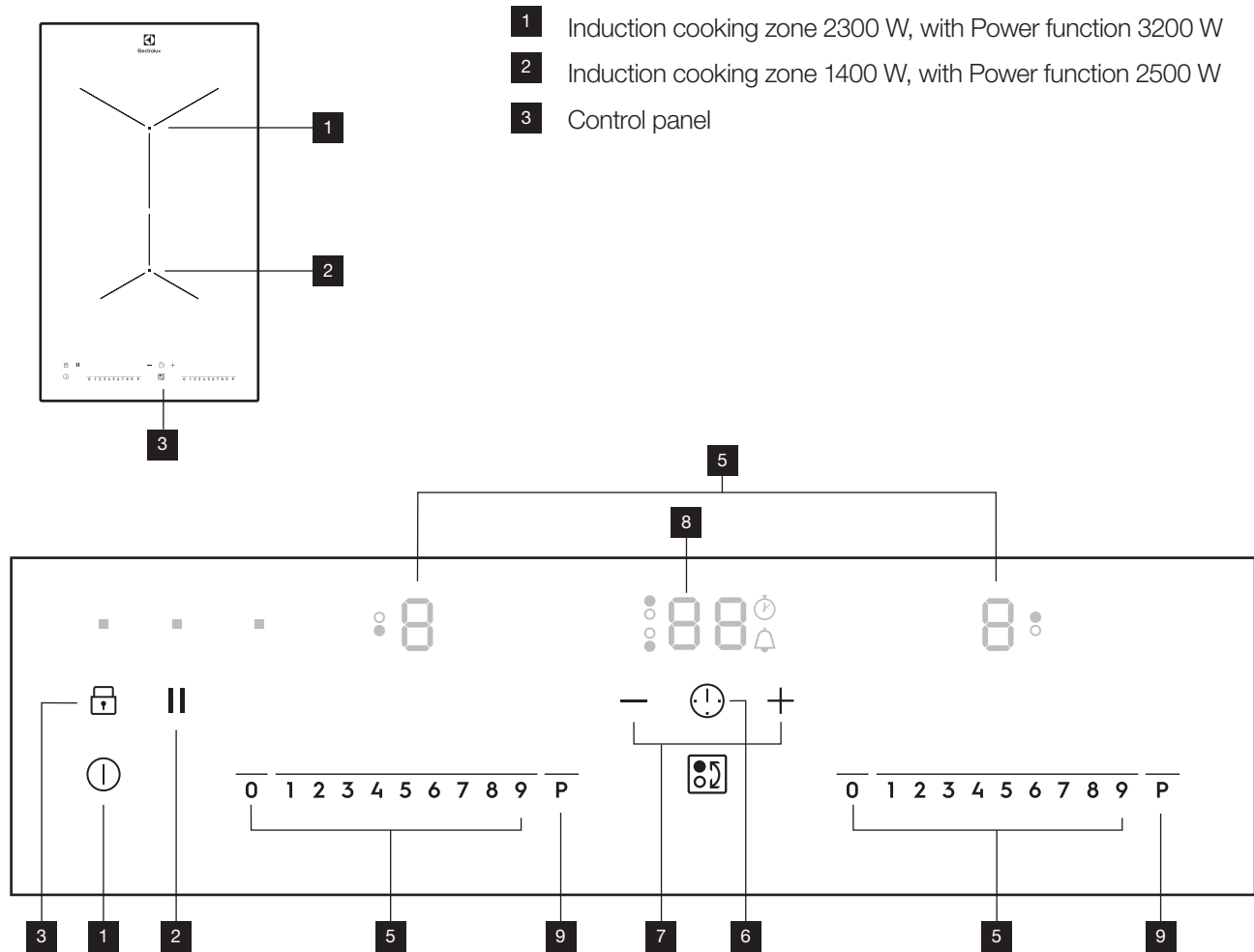











Use the sensor fields to operate the appliance. The displays, indicators and sounds tell which functions operate.

Sensor field	Function
1	It activates and deactivates the appliance
2	Sets all operating zones to a keep warm setting
3	It locks/unlocks the control panel
4	Increase or decrease the heat setting
5 A heat setting display	Shows the heat setting
6	To set the timer function
7	It increases or decreases the time
8 The timer display	It shows the time in minutes
9	It activates the Power function

## PRODUCT DESCRIPTION (CONTINUED)

### Heat setting displays

Display	Description
	The cooking zone is deactivated.
	The cooking zone operates.
	The Keep Warm function operates.
	The Automatic Heat-up function operates.
	The cookware is incorrect or too small, or there is no cookware on the cooking zone.
	There is a malfunction.
	A cooking zone is still hot (residual heat).
	The Lock/Child Safety device operates.
	The Power function operates.
	The Automatic Switch-Off operates.

### OptiHeat Control ( 3 step residual heat indicator)



#### WARNING

#### Risk of burns from residual heat!

OptiHeat Control shows the level of the residual heat. The induction cooking zones make the heat necessary for cooking directly in the bottom of the cookware. The glass ceramic is hot from the heat of the cookware.



#### ENVIRONMENT

##### Disposal

The symbol  on the product or on its packaging indicates that this product may not be treated as household waste. Instead it should be taken to the appropriate collection point for the recycling of electrical and electronic equipment. By ensuring this product is disposed of correctly, you will help prevent potential negative consequences for the environment and human health, which could otherwise be caused by inappropriate waste handling of this product. For more detailed information about recycling of this product, please contact your local council, your household waste disposal service or the shop where you purchased the product.

##### Packaging material

The packaging materials are friendly to the environment and can be recycled. The plastic components are identified by marking: >PE<,>PS<, etc. Discard the packaging materials as household waste at the waste disposal facilities in your municipality.



# OPERATING INSTRUCTIONS

## Activation and deactivation

Touch **ⓘ** for 1 second to activate or deactivate the appliance.

## Automatic switch off

The function deactivates the appliance automatically if:

- All cooking zones are deactivated (**⏻**).
- You do not set the heat setting after you activate the appliance.
- You spill something or put something on the control panel for more than 10 seconds, (a pan, a cloth, etc.). The sound operates until you remove the object. Remove the object or clean the control panel.
- The appliance become too hot (e.g. when a saucepan boils dry). Before you use the appliance again, the cooking zone must be cool.
- You use incorrect cookware. The symbol **F** comes on and the cooking zone deactivates automatically after 2 minutes.
- You do not deactivate a cooking zone or change the heat setting. After some time, **-** comes on and the appliance deactivates. See the table.

## The times of Automatic Switch Off

Heat setting	Cooking zone deactivates after
1-2	6 hours
3-4	5 hours
5	4 hours
6-9	1.5 hours

## The heat setting

Touch the control bar at the heat setting. Change to the left or the right, if it is necessary. Do not release before you have a correct heat setting. The display shows the heat setting.

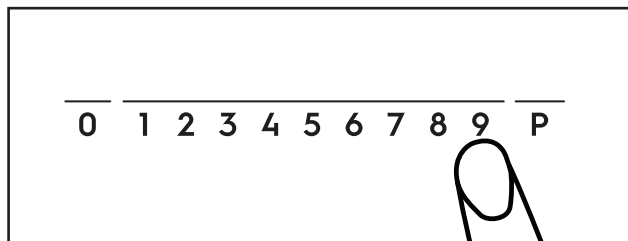

## Automatic heat up

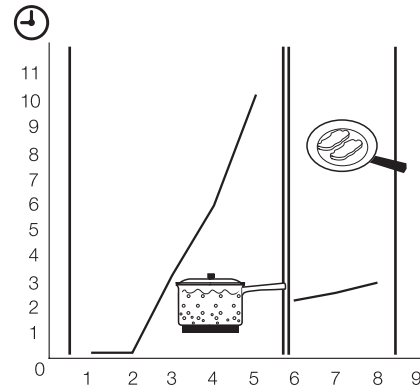

You can get a necessary heat setting in a shorter time if you activate the Automatic Heat Up function. This function sets the highest heat setting for some time (see the illustration above), and then decreases to the necessary heat setting.

To start the Automatic Heat Up function for a cooking zone:

1. Touch **P**. The symbol **P** comes on in the display.
2. Immediately touch the necessary heat setting. After 3 seconds **P** comes on in the display. To stop the function change the heat setting.

## Switching on and off the power function









The Power function makes more power available to the induction cooking zones. The Power function is activated for 5 minutes at most. After that the induction cooking zone automatically switches back to heat setting **9**. To switch on, touch **P**, **P** comes on. To switch off, touch a heat setting between **1** and **9**.

## OPERATING INSTRUCTIONS (CONTINUED)

### Timer



Use the Count Down Timer to set how long the cooking zone operates for one cooking session. **Set the Count Down Timer after the selection of the cooking zone.**

You can set the heat setting before or after you set the timer.

- To set the cooking zone: touch  again and again until the indicator of the necessary cooking zone comes on.
- To activate or change the Timer: touch + or – of the timer to set the time (00 - 99 minutes). When the indicator of the cooking zone starts to flash slow, the time counts down.
- To deactivate the Timer: select the cooking zone with  and touch – to deactivate the Timer. The remaining time counts back to . The indicator of the cooking zone goes out.
- To see the remaining time: select the cooking zone with . The indicator of the cooking zone starts to flash quickly. The display shows the remaining time. When the time comes to an end, the sound operates and  flashes. The cooking zone deactivates.
- To stop the sound: touch . You can use the Timer as a minute minder while the cooking zones do not operate. Touch . Touch + or – to set the time. When the time comes to an end, the sound operates and  flashes.

### Minute minder

You can use the timer as a Minute Minder while cooking zones are not operating.

- Touch .
- Touch + or – of the timer to select the time. When the time elapses, the sound operates and 00 flashes.
- Stopping the sound: touch .

### Pause

The **II** function sets all cooking zones that operate to the lowest heat setting .



When **II** operates, you cannot change the heat setting.

The **II** function does not stop the timer function.

- To activate this function touch **II**. The  symbol comes on.
- To deactivate this function touch **II**. The heat setting that you set before comes on.

### Lock





When the cooking zones operate, you can lock the control panel, but not . It prevents an accidental change of the heat setting.

- Touch the symbol . The symbol  comes on for 4 seconds.
- To stop this function touch . The heat setting that you set before comes on. When you stop the appliance, you also stop this function.





### The child safety device

This function prevents an accidental operation of the appliance.





#### To activate the child safety device

- Activate the appliance with . Do not set the heat settings.
- Touch  for 4 seconds. The symbol  comes on.
- Deactivate the appliance with .

#### To deactivate the child safety device

- Activate the appliance with . Do not set the heat settings. Touch  for 4 seconds. The symbol  comes on.
- Deactivate the appliance with .

#### To override the child safety device for only one cooking time

- Activate the appliance with . The symbol comes on .
- Touch  for 4 seconds. Set the heat setting in 10 seconds. You can operate the appliance.
- When you deactivate the appliance with , the child safety device operates again.

## HELPFUL HINTS AND TIPS

### IMPORTANT

Use the induction cooking zones with correct cookware.

- Cookware made of enamelled steel and with aluminium or copper bottoms can cause discolouration on glass ceramic surface.

**Cookware for induction cooking zones**

### IMPORTANT

For induction cooking zones a strong electro-magnetic field creates the heat in the cookware very quickly.

**Cookware material**

- **Correct:** cast iron, steel, enamelled steel, stainless steel, the bottom made of multi-layer (with correct mark from a manufacturer).
- **Not correct:** aluminium, copper, brass, glass, ceramic, porcelain.

**Cookware is correct for an induction hob if:**

### FIND THE RIGHT COOKWARE

Only magnetic pots and pans work with induction. Check to see if your cookware is compatible: Place a magnet on the bottom of your pot or pan - if it clings firmly, the cookware will work with your cooktop.

Choose the right size pot or pan for the right cooking zone.



#### **MAGNET STICKS**

Cookware base material has good magnetic characteristics



#### **MAGNET FALLS**

Cookware base material is non-magnetic

- Some water boils very quickly on a zone set to the highest heat setting.
- A magnet pulls on to the bottom of the cookware.

### IMPORTANT

**The bottom of the cookware must be as thick and flat as possible. Cookware dimensions: induction cooking zones adapt to the dimension of the bottom of the cookware automatically to some limit.**

**The noises during operation**

If you can hear;

- **crack noise:** cookware is made of different materials (sandwich construction).
- **whistle sound:** you use one or more cooking zones with high power levels and the cookware is made of different materials (Sandwich construction).
- **humming:** you use high power levels.
- **clicking:** electric switching occurs.
- **hissing, buzzing:** the fan operates.

The noises are normal and do not refer to appliance malfunction.

If unfamiliar with induction units please first compare the operating sounds of a demonstration model at your retailer before calling service. If a service call is placed and the sounds are normal you will be charged for the visit.

**Energy saving**



### ENVIRONMENT

- If it is possible, always put the lids on the cookware.
- Put cookware on a cooking zone before you start it.

## The examples of cooking applications

The data in the table is for guidance only.

heat setting	use to:	time	hints
1	Keep warm the food you cooked	as required	Put a lid on a cookware
1-2	Hollandaise sauce, melt: butter, chocolate, gelatine	5-25 min	Mix from time to time
1-2	Solidify: fluffy omelettes, baked eggs	10-40 min	Cook with a lid on
2-3	Simmer rice and milk based dishes, heating up ready-cooked meals	25-50 min	Add the minimum twice as much liquid as rice, mix milk dishes part procedure through
3-4	Steam vegetables, fish, meat	20-45 min	Add some tablespoons of liquid
4-5	Steam potatoes	20-60 min	Use max. 1/4L water for 750g of potatoes
4-5	Cook larger quantities of food, stews and soups	60-150 min	Up to 3L liquid plus ingredients
6-7	Gentle fry: escalope, veal cordon bleu, cutlets, rissoles, sausages, liver, roux, eggs, pancakes, doughnuts	as required	Turn halfway through
7-8	Heavy fry, hash browns, loin steaks, steaks	5-15 min	Turn halfway through
9	Boil large quantities of water, cook pasta, sear meat (goulash, pot roast), deep-fry chips		

The Power function is best to heat up large quantities of water.

# CARE AND CLEANING

## Ceramic Cooktop Cleaning

### **i** IMPORTANT

Sometimes SURFACE stains appear to be a “bubble” mark under the ceramic glass. These can be cleaned off with a razor blade scraper and ceramic cleaner.

Keeping the ceramic cooktop clean and protected will keep it in good condition and help avoid breakage.

**Ceramic Scraper**  
0383001001



**Cerapol Cleaner**  
ACC019



**Ceraseal Protector**  
ACC018



- If the deposit is minimal, simply wipe off with a dry cloth.
- If the deposit is more stubborn, clean off with a moist soapy sponge then rinse off.
- If the deposit still does not clean off easily, use a non-abrasive nylon scratch pad and special purpose ceramic glass cleaning agent such as Cerapol cleaner (ACC019 - Available from our web shop).
- If the deposits are still burnt on and above methods did not work, use a specially designed ceramic glass scraper(0383001001 - Available from our web shop).

After having successfully cleaned the cooktop, apply a ceramic glass conditioner Ceraseal protector (ACC018 - Available from our web shop). The conditioner will leave a protective coating that will help prevent future stains from becoming baked on. Marks which appear to be bubbles under the ceramic will also clean off. Use Ceraseal (ACC018) to help protect the ceramic and allow for easier cleaning. Polish on with a dry clean cloth.

Available at the following web shops:  
<https://shop.westinghouse.com.au>

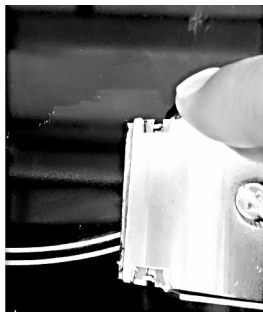
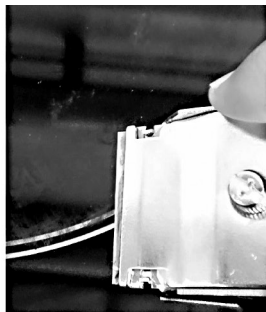

Marks which appear to be bubbles under the ceramic will also clean off.

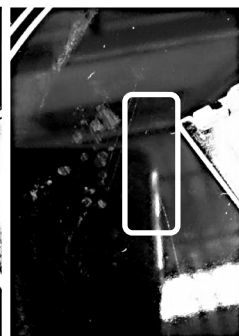
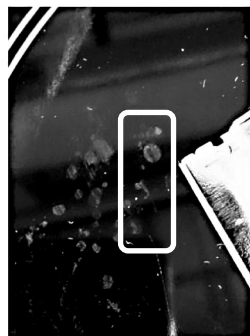

Use Ceraseal (ACC018) to help protect the ceramic and allow for easier cleaning. Polish on with a dry clean cloth.



# TROUBLESHOOTING

Problem	Possible cause and remedy	Remedy
Red rings, limescale or water rings, shiny metallic or other discolouration, scratches/shadows, bubbles or other miscellaneous marks or stains on ceramic glass cooktop surface.	Cooktop surface has not been cleaned correctly. Cleaning/ maintenance of the cooktop surface is not covered under warranty. If a service call is placed to clean the cooktop you will be charged for the visit.	Use a ceramic glass cleaner such as Cerapol.
Pitting of ceramic glass surface.	Spillovers of liquid with high sugar content.	These types of spills must be removed immediately with a special scraper for the glass. If not permanent damage to the cooktop glass can occur which is not covered under warranty.
You cannot activate the appliance or operate it.	<p>You touched 2 or more sensor fields at the same time.</p> <p>The <b>  </b> function operates.</p> <p>There is water or fat stains on the control panel.</p>	<p>Touch only one sensor field.</p> <p>Refer to the chapter "Operating instructions"</p> <p>Clean the control panel.</p>
You cannot activate the appliance or operate it.	<p>You touched 2 or more sensor fields at the same time.</p> <p>The Child Safety Device or the Lock or <b>  </b> operates.</p> <p>There is water or fat stains on the control panel.</p>	<p>Activate the appliance again and set the heat setting in 10 seconds.</p> <p>Only touch one sensor field.</p> <p>See the chapter Operating instruction.</p> <p>Clean the control panel.</p>
A Sound operates and the appliance deactivates. A sound operates when the appliance is deactivated.	You put something on one or more sensor fields.	Remove the object from the sensor fields.
The appliance deactivates.	You put something on the  .	Remove object from the sensor field.

## TROUBLESHOOTING (CONTINUED)

Problem	Possible cause and remedy	Remedy
The residual heat indicator does not come on.	The cooking zone is not hot because it operated only for a short time.	If the cooking zone should be hot, speak to the service centre.
The Automatic Heat Up function does not operate.	There is still residual heat on the cooking zone. The highest heat setting is set.	Let the cooking zone become sufficiently cool. The highest heat setting has the same power as the Automatic Heat Up function.
The heat setting changes between two levels.	The Power management is activated.	See the section Power management.
The sensor fields become hot.	The cookware is too large or you put it too near to the controls.	Put large cookware on the rear cooking zones if it is necessary.
- comes on	The Automatic Switch Off operates.	Deactivate the appliance and activate it again.
F comes on	No cookware on the cooking zone. Not correct cookware. The diameter of the bottom of the cookware is too small for the cooking zone.	Put cookware on the cooking zone. Use the correct cookware. Move cookware to a smaller cooking zone.
E and a number comes on.	There is an error in the appliance.	Disconnect the appliance from the electrical supply for some time. Disconnect the fuse from the electrical system of the house. Connect again. If E comes on again, speak to the service centre.
E4 comes on	There is an error in the appliance, because either the cookware boils dry or you've used incorrect cookware. Overheating protection for cooking zone operates. The automatic switch-off operates.	Deactivate the appliance. Remove the hot cookware. After approximately 30 seconds, activate the cooking zone again. If the cookware was the problem, the error message goes out of the display, but the residual heat indicator can stay. Let the cookware become sufficiently cool and refer to "Cookware for the induction cooking zone" to see if your cookware is compatible with the appliance.



### WARNING

Repairs to the appliance are only to be carried out by qualified service engineers. Considerable danger to the user may result from improper repairs.



### IMPORTANT

If the appliance has been wrongly operated, the visit from the customer service technician or dealer may not take place free of charge, even during the warranty period.

# Electrolux Warranty

FOR SALES IN AUSTRALIA AND NEW ZEALAND  
 APPLIANCE: ELECTROLUX BUILT-IN OVENS, COOKTOPS,  
 FREESTANDING COOKER AND WARMING DRAWER

**This document sets out the terms and conditions of the product warranties for Electrolux Appliances. It is an important document. Please keep it with your proof of purchase documents in a safe place for future reference should there be a manufacturing defect in your Appliance. This warranty is in addition to other rights you may have under the Australian Consumer Law.**

**1. In this warranty:**

- (a) 'ACL' or 'Australian Consumer Law' means Schedule 2 to the Competition and Consumer Act 2010;
- (b) 'Appliance' means any Electrolux product purchased by you and accompanied by this document;
- (c) 'ASC' means Electrolux's authorised serviced centres;
- (d) 'Electrolux' is the brand controlled by Electrolux Home Products Pty Ltd of 163 O'Riordan Street, Mascot NSW 2020, ABN 51 004 762 341 in respect of Appliances purchased in Australia and Electrolux (NZ) Limited (collectively "Electrolux") of 3-5 Niall Burgess Road, Mount Wellington, in respect of Appliances purchased in New Zealand;
- (e) 'Warranty Period' means the period specified in clause 3 of this warranty;
- (f) 'you' means the purchaser of the Appliance not having purchased the Appliance for re-sale, and 'your' has a corresponding meaning.

**2. Application:** This warranty only applies to new Appliances, purchased and used in Australia or New Zealand and is in addition to (and does not exclude, restrict, or modify in any way) other rights and remedies under a law to which the Appliances or services relate, including any non-excludable statutory guarantees in Australia and New Zealand.

**3. Warranty Period:** Subject to these terms and conditions, this warranty continues in Australia for a period of 24 months and in New Zealand for a period of 24 months, following the date of original purchase of the Appliance.

**4. Repair or replace warranty:** During the Warranty Period, Electrolux or its ASC will, at no extra charge if your Appliance is readily accessible for service, without special equipment and subject to these terms and conditions, repair or replace any parts which it considers to be defective. Electrolux may, in its absolute discretion, choose whether the remedy offered for a valid warranty claim is repair or replacement. Electrolux or its ASC may use refurbished parts to repair your Appliance. You agree that any replaced Appliances or parts become the property of Electrolux.

**5. Travel and transportation costs:** Subject to clause 7, Electrolux will bear the reasonable cost of transportation, travel and delivery of the Appliance to and from Electrolux or its ASC. Travel and transportation will be arranged by Electrolux as part of any valid warranty claim.

**6. Proof of purchase** is required before you can make a claim under this warranty.

**7. Exclusions:** You may not make a claim under this warranty unless the defect claimed is due to faulty or defective parts or workmanship. This warranty does not cover:

- (a) light globes, batteries, filters or similar perishable parts;
- (b) parts and Appliances not supplied by Electrolux;
- (c) cosmetic damage which does not affect the operation of the Appliance;

- (d) damage to the Appliance caused by:
  - (i) negligence or accident;
  - (ii) misuse or abuse, including failure to properly maintain or service;
  - (iii) improper, negligent or faulty servicing or repair works done by anyone other than an Electrolux authorised repairer or ASC;
  - (iv) normal wear and tear;
  - (v) power surges, electrical storm damage or incorrect power supply;
  - (vi) incomplete or improper installation;
  - (vii) incorrect, improper or inappropriate operation;
  - (viii) insect or vermin infestation;
  - (ix) failure to comply with any additional instructions supplied with the Appliance;

In addition, Electrolux is not liable under this warranty if:

- (a) the Appliance has been, or Electrolux reasonably believes that the Appliance has been, used for purposes other than those for which the Appliance was intended, including where the Appliance has been used for any non-domestic purpose;
- (b) the Appliance is modified without authority from Electrolux in writing;
- (c) the Appliance's serial number or warranty seal has been removed or defaced

**8. How to claim under this warranty:** To enquire about claiming under this warranty, please follow these steps:

- (a) carefully check the operating instructions, user manual and the terms of this warranty;
- (b) have the model and serial number of the Appliance available;
- (c) have the proof of purchase (e.g. an invoice) available;
- (d) telephone the numbers shown below.

**9. Australia:** For Appliances and services provided by Electrolux in Australia: Electrolux goods come with guarantees that cannot be excluded under the Australian Consumer Law. You are entitled to a replacement or refund for a major failure and for compensation for any other reasonably foreseeable loss or damage. You are also entitled to have the Appliance repaired or replaced if the Appliance fails to be of acceptable quality and the failure does not amount to a major failure. 'Acceptable quality' and 'major failure' have the same meaning as referred to in the ACL.

**10. New Zealand:** For Appliances and services provided by Electrolux in New Zealand, the Appliances come with a guarantee by Electrolux pursuant to the provisions of the Consumer Guarantees Act, the Sale of Goods Act and the Fair Trading Act. Where the Appliance was purchased in New Zealand for commercial purposes the Consumer Guarantee Act does not apply.

**11. Confidentiality:** You accept that if you make a warranty claim, Electrolux and its agents including ASC may exchange information in relation to you to enable Electrolux to meet its obligations under this warranty.

**Important Notice**

Before calling for service, please ensure that the steps listed in clause 8 above have been followed.

<b>AUSTRALIA</b>	<b>FOR SERVICE</b> or to find the address of your nearest authorised service centre in Australia <b>PLEASE CALL 13 13 49</b> <small>For the cost of a local call</small>	<b>FOR SPARE PARTS</b> or to find the address of your nearest spare parts centre in Australia <b>PLEASE CALL 13 13 50</b> <small>For the cost of a local call</small>
<b>NEW ZEALAND</b>	<b>FOR SERVICE</b> or to find the address of your nearest authorised service centre in New Zealand <b>PLEASE CALL 0800 10 66 10</b>	<b>FOR SPARE PARTS</b> or to find the address of your nearest spare parts centre in New Zealand <b>PLEASE CALL 0800 10 66 20</b>

**Electrolux Home Products Australia**

telephone: 1300 363 640  
email: [customercare@electrolux.com.au](mailto:customercare@electrolux.com.au)  
web: [electrolux.com.au](http://electrolux.com.au)

**shop.electrolux.com.au**



**Electrolux Home Products New Zealand**

telephone: 0800 436 245  
email: [customercare@electrolux.co.nz](mailto:customercare@electrolux.co.nz)  
web: [electrolux.co.nz](http://electrolux.co.nz)



To add a touch of professional inspiration to your home, visit [electrolux.com.au](http://electrolux.com.au) or [electrolux.co.nz](http://electrolux.co.nz)

[electrolux.com.au](http://electrolux.com.au)



or [electrolux.co.nz](http://electrolux.co.nz)

