

Westinghouse

FRONT LOADING WASHING MACHINE USER MANUAL

LF 651 D

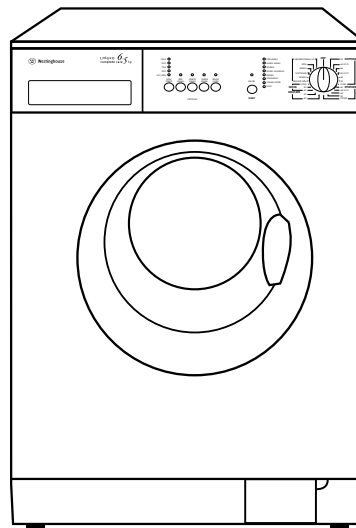

Contents

Warnings	3	Operating sequence	13-14
Disposal	4	Washing programs	15-16
		International wash code symbols	17
Tips for environmental protection	4	Maintenance	18
Technical specifications	4	After each wash	18
Installation	5	Maintenance wash	18
Unpacking	5	Door seal	18
Positioning	5	Cabinet	18
Water inlet	5	Detergent dispenser drawer	18
Water drainage	6	Drain pump	19
Electrical connection	6	Water inlet filter	19
		Emergency emptying out	20
Your new washing machine	7	The dangers of freezing	20
Detergent dispenser drawer	7	Trouble-Shooting Guide	21-22
Use	8	Electrolux Warranty	
Control panel	8	New Zealand	23
Controls	8-10	Electrolux Warranty	
Washing hints	11	Australia	24
Sorting the laundry	11		
Temperatures	11		
Before loading the laundry	11		
Maximum loads	11		
Laundry weights	11		
Removing stains	11-12		
Detergents and additives	12		

The symbols you will see on some paragraphs of this booklet have the following meaning:



The warning triangle and/or the key words (Warning!, Caution!) emphasize information that is particularly important for your safety or correct functioning of the appliance.



The information marked with this symbol provides additional instructions and practical tips on the use of the appliance.



Tips and information about economical and ecological use of the machine are marked with this symbol.

Our contribution to the protection of the environment: we use environmentally friendly paper.

Dear customer,

Please read these operating instructions carefully and pay particular attention to the safety notes indicated below. We recommend that you keep this instruction manual for future reference and pass it on to future owners.

Warnings

The following warnings are provided in the interest of your overall safety. You read them carefully before installing or using the appliance.

Installation

- When unpacking the appliance, check it is not damaged. If in doubt, do not use the appliance and contact the Service Centre.
- All internal packaging must be removed before using the appliance. Serious damage may be caused to the machine or adjacent furniture if protective transit devices are not completely removed. Refer to the relevant paragraph in the instruction book.
- Any electrical work required to install this appliance must be carried out by a qualified electrician.
- Any plumbing work required to install this appliance must be carried out by a qualified plumber.
- After having installed the machine, check that it is not standing on its electrical supply cable.
- If the appliance is placed on a carpeted floor, ensure air can circulate freely between the feet and floor.
- The appliance incorporates backflow protection complying with AS/NZS 3500.1.2. No further backflow protection is required for connection to the water supply.

Use

- This appliance is designed for domestic use. It must not be used for purposes other than those for which it was designed.
- Only wash fabrics which are designed to be machine washed. Follow the instructions on each garment label.
- Do not overload the appliance. Follow the instructions in the instruction book.
- Make sure all pockets are empty. Objects such as coins, safety pins and screws can cause extensive damage.
- Do not machine wash garments saturated with petroleum, methylated spirits, trichlorethylene, etc. If such fluids have been used to remove stains prior to washing wait until they have completely evaporated from the fabric before placing garments in the washing machine.

- Place small items such as socks, belts etc in a cloth bag or pillowcase to prevent trapping between the drum and the tub.
- Use only the recommended dosage of fabric softener. Excessive amounts could damage the garments.
- Leave the porthole door slightly ajar when the appliance is not in use. This preserves the door seal and prevents the formation of musty smells.
- Always check the water has drained before opening the door. If not, drain the water following the instructions in the instruction book.
- Always unplug the appliance and turn the water tap off after use.

General safety

- Repairs to the machine must be carried out by a qualified technician. Repairs carried out by inexperienced tradesmen, could cause serious danger. Contact your local Service Centre.
- Never pull the power supply cable when removing the plug from the socket; always take hold of the plug.
- During high temperature wash programs the door glass may get hot. Do not touch it!

Child safety

- This washing machine is not intended for use by young children or infirm persons without supervision.
- Young children should be supervised at all times, ensuring they do not play with the appliance.
- Packaging components (e.g. plastic film, polystyrene) can cause suffocation, and can be dangerous to children. Keep them out of children's reach.
- Keep all detergents in a safe place out of children's reach.
- When discarding the appliance, cut the electrical supply cable and destroy the plug with the remaining cable. Disable the door catch in order to prevent young children from becoming trapped inside the machine while playing.

- Make sure children or pets do not climb into the drum. To avoid this the machine incorporates a safety device. To activate this device, rotate the button (without pressing) inside the door clockwise until the groove is horizontal. If necessary use a coin.

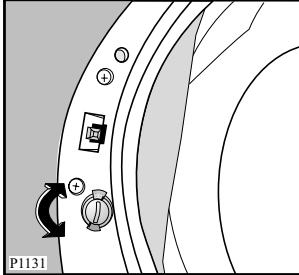

To disable this device and restore the possibility of closing the door, rotate the button anti-clockwise until the groove is vertical.



Disposal

Packaging materials

The materials marked with the symbol  are recyclable.

>PE<=polyethylene

>PS<=polystyrene

>PP<=polypropylene

This means these materials can be recycled properly by disposing them in appropriate collection containers.

Machine

Use authorised disposal sites for your old appliance. Help keep Australia tidy!



Tips for environmental protection

To save water, energy and to help protect the environment, we recommend you follow these tips:

- Normally soiled laundry may be washed without prewashing order to save detergent, water and time (the environment is protected too!).
- The machine works more economically if it is fully loaded.
- With adequate pre treatment, lightly soiled stains can be removed, the laundry wash load can then be washed at a lower temperature.
- Measure the detergent according to water hardness, the degree of soiling, and the quantity of laundry being washed.

Technical specifications

DIMENSIONS	Height	85 cm
	Width	60 cm
	Depth	57 cm
MAXIMUM LOAD	Cotton	6,5 kg
	Synthetics	3 kg
	Delicates	3 kg
	Woollens	2 kg
MAX. SPIN SPEED		1000 rpm
POWER SUPPLY VOLTAGE		220-240 V
FREQUENCY		50 Hz
TOTAL POWER ABSORBED		2050 W
MINIMUM FUSE PROTECTION		10 A
WATER PRESSURE	Minimum	50 kPa
	Maximum	800 kPa

Installation

Unpacking

 All transit bolts and packing must be removed before using the appliance.

You are advised to keep all transit devices so that they can be refitted if the machine ever has to be transported again.

1. Use a spanner to unscrew and remove the two rear bottom screws. Slide out the two plastic pins, lay the machine on its back, do not squash the hoses. This can be avoided by placing one of the corner packing pieces between the machine and the floor.

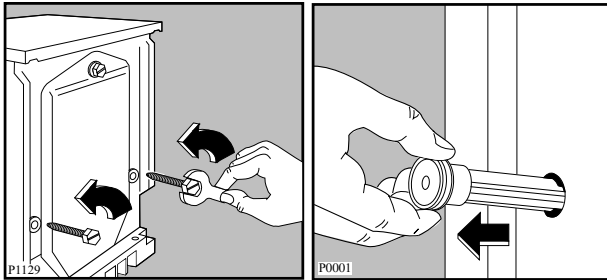

2. Remove the polystyrene block(s) from the bottom of the machine and release the two plastic bags.
3. Very carefully slide out the left polythene bag, removing it towards the right and then downwards.

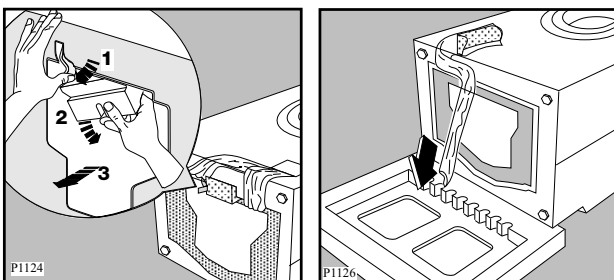

4. Very carefully slide out the right polythene bag, removing it towards the left and then upwards.

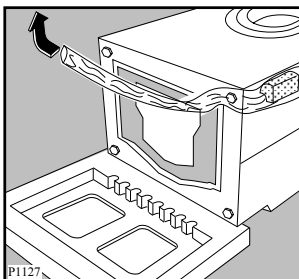

5. Set the machine upright and remove the remaining rear screw. Slide out the relevant pin.
6. Plug all the holes with the plugs which you will find in the envelope containing the instruction manual.

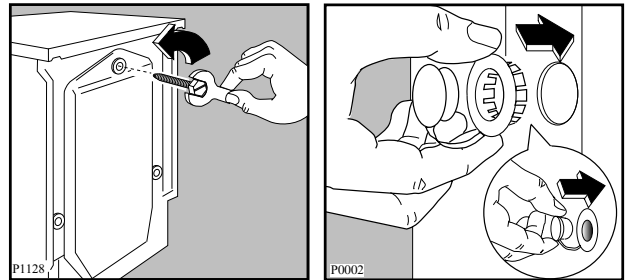

Positioning

Install the machine on a flat hard floor. Make sure the air circulation around the machine is not impeded by carpets, rugs etc. Check the machine does not touch the wall or cupboard units. Carefully level by screwing the adjustable feet in or out. Never place the cupboard, wood or similar materials under the machine to compensate for any unevenness in the floor.

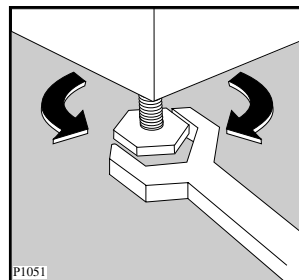

Water inlet

Connect the water inlet hose to a tap with 3/4" BSP thread.

Use the hose supplied with the washing machine. **DO NOT USE OLD HOSES.**

The other end of the inlet hose which connects to the machine can be turned in any direction. Simply loosen the fitting, rotate the hose and retighten the fitting, making sure there are no water leaks.

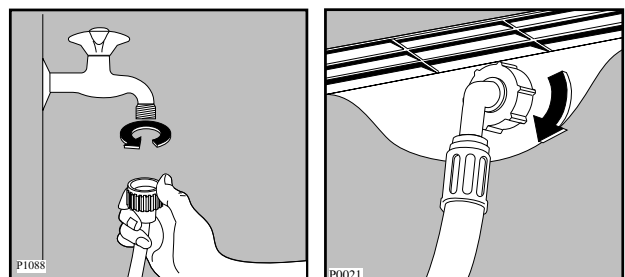

The inlet hose must not be lengthened. If it is too short and you do not wish to move the tap, you will have to purchase a new, longer hose specially designed for this type of use.

Important!

Before connecting the machine to new pipework or pipework which has not been used for sometime, run a reasonable amount of water to flush out any debris that may have been collected in the pipes.

Water drainage

The end of the drain hose can be positioned in four ways:

Hooked over the edge of a sink using the plastic hose guide supplied with the machine. In this case, make sure the end cannot come unhooked when the machine is emptying.

This could be done by tying it to the tap with a piece of string or attaching it to the wall.

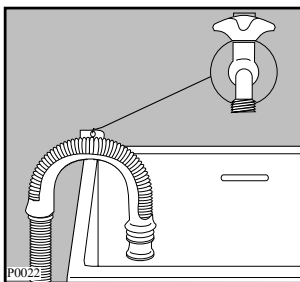

In a sink drain pipe branch. This branch must be above the tap so that the bend is at least 60 cm above the ground.

Directly into a drain pipe at a height of no less than 60 cm and no more than 90 cm. The end of the drain hose must always be **ventilated**, i.e. the inside diameter of the drain pipe must be larger than the outside diameter of the drain hose.

Floor drain: the washing machine should be installed where a floor drain or hole is located (depending on plumbing regulations). A floor drain is required to drain away water which may overflow from the washing machine due to a hose leak or malfunction.

The drain hose must not be kinked. Run it along the floor; only the part near the drainage point must be raised.

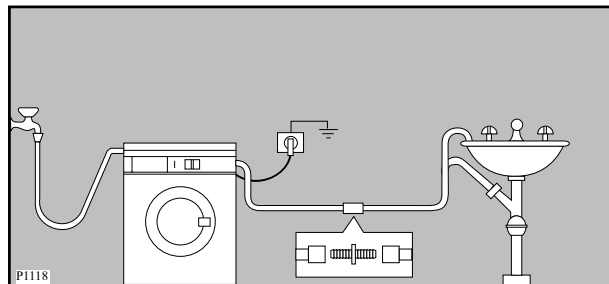

The drain hose may be extended to a maximum of 4 metres. An additional drain hose and joining piece is available from your local Service Centre.

For correct operation of the machine the drain hose must remain hooked to the correct support piece situated on the top of the back side of the appliance.

Electrical connection

Plug the washing machine into a properly earthed 3 pin power point.

DO NOT USE AN EXTENSION CORD.

CAUTION !

If the appliance is supplied from a cord extension set to an electrical porthole outlet device, the cord extension set or electrical portable outlet device must be positioned so it is not subjected to splashing or ingress of moisture.



The manufacturer declines any responsibility for damage or injury through failure to comply with the above safety precaution.

IMPORTANT!

If the electrical cord of this appliance is damaged, it must be replaced by the Manufacturer, Authorised Service Agent or similarly qualified person in order to avoid a hazard.

Your new washing machine

The LF 651D washing machine meets all modern needs for effective treatment of laundry with low water, energy and detergent consumption.

- **By selecting the temperature, spin speed and options** offered on this washing machine, you truly get a customised wash result.
- **The program progress display** shows the washing phase which is running.
- **The special WOOL program** with its new delicate wash system treats your woollens with extreme care.
- **The automatic cooling of washing water** from 95° to 60°C before draining will prevent old drain pipes from becoming deformed and will reduce thermal shock to fabrics preventing creasing.
- **The balance control device** ensures the machine is stable during the spin.
- **The ECO valve** allows total use of detergent and reduced water consumption, saving energy.

- 1 Detergent dispenser drawer
- 2 Control panel
- 3 Door opening handle
- 4 Drain pump
- 5 Adjustable feet

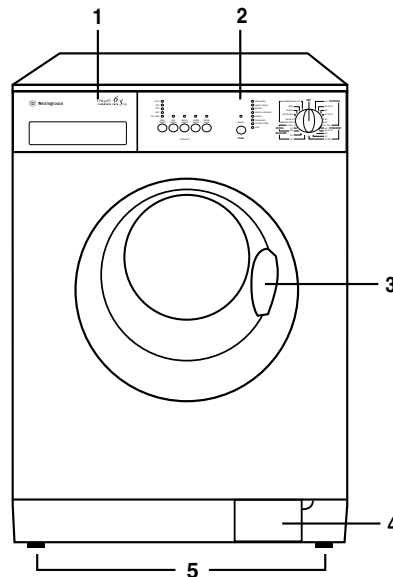

Detergent dispenser drawer

The detergent dispenser is divided into three compartments (fig.). The table of Washing Programmes shows which compartment to use.

Compartment  : This compartment is only used for washing power when the prewash program is selected.

Compartment  : this compartment is used for washing powder on all programs.

Compartment  : this compartment is used for fabric conditioner and starching agent.

Always add laundry detergents before switching the machine on and keep the dispenser clean and dry, so that the detergent can be efficiently dispensed from the unit.

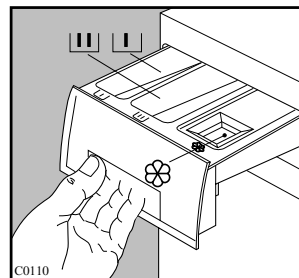

Use

Control panel

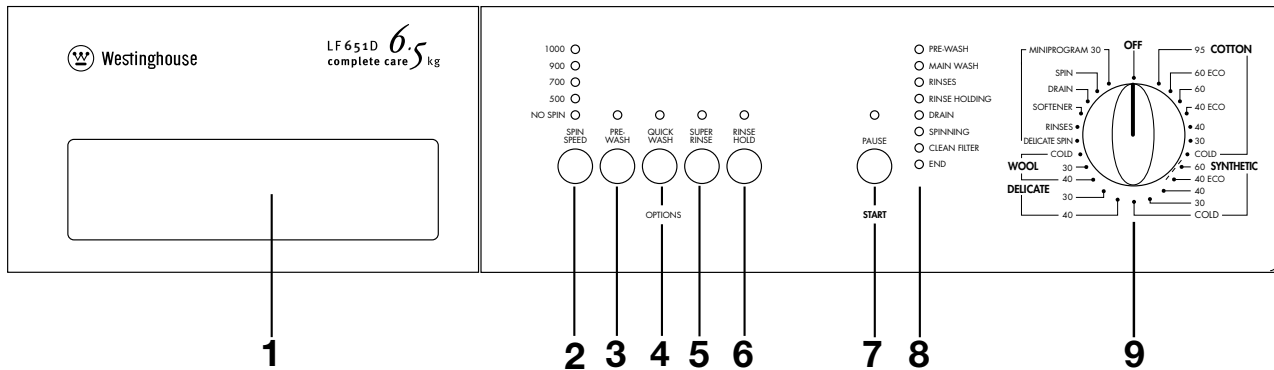

1 Detergent dispenser drawer

2 SPIN SPEED button

Press this button to reduce the maximum speed of the final spin proposed by the machine for the selected program or to select the "NO SPIN" option. The light corresponding to the selected option illuminates.

Spin speed

The following speeds are available for different fabrics:

- Cotton, linen:
500/700/900 max 1000 r.p.m.;
- Synthetics and wool:
500/700 max 900 r.p.m.;
- Delicates:
500 max 700 r.p.m.

By selecting the "NO SPIN" option all the spinning phases are suppressed.

If you select this option with programs for cotton and synthetics, the machine will perform some extra rinses.

Option buttons

Depending on the program different functions can be combined. Functions must be selected after choosing the desired program, and before depressing the "Start/Pause" button.

When these buttons are pressed, the corresponding pilot lights come on. When they are pressed again, lights go out.

If an incorrect option is selected, the pilot light flashes for 2 seconds.

3 PREWASH button

Select this option if you require your laundry to be prewashed before the main wash cycle. The prewash cycle ends with a short spin at 650 r.p.m. in programs for cotton and synthetics, and with emptying of the water for delicates. This option is **not** available with the wool program. Select when washing heavily soiled garments.

4 QUICK WASH button

Select this option for lightly soiled garments in order to obtain a good washing result in a short period of time.

This option is **not available** with the wool, ECO or MINIPROGRAM 30.

5 SUPER RINSE button

Super rinse can be selected with all programs except wool. The machine will add 2 rinses to the selected program. Super rinse is recommended for people who are allergic to detergents, and areas where the water is very soft.

6 RINSE HOLD button

When selecting Rinse Hold, the machine will not drain the water of the last rinse, to prevent wrinkles. The relevant light illuminates and will stay on during washing.

At the end of the cycle the RINSE HOLD option and the RINSE HOLDING pilot light are on, the **START/PAUSE** button light goes out and the door is locked to indicate the water must be drained.

To complete the cycle there are two possibilities to choose from:

- Select the DRAIN program : the water is emptied out without spinning.
- Select SPIN or DELICATE SPIN programs. Select the spin speed by means of the relevant button and then depress the **START/PAUSE** button. The water is drained and garments spun to the selected spin speed.

Attention!

Before selecting programs DRAIN, SPIN or DELICATE SPIN, the selector dial has to be positioned on **OFF**.

7 START/PAUSE button

This button has two functions:

Start – Pause.



When selected the required program, press this button to start the machine. The corresponding pilot light stops flashing.

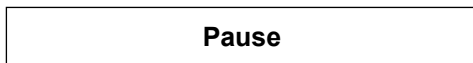

To interrupt a program, depress the **START/PAUSE** button: the corresponding pilot lights starts to flash. To restart the program from the point at which it was interrupted, **press the START/PAUSE button again.**

8 Programme progress display

By selecting the wash program, the pilot lights corresponding to the various phases making up the program come on.

After the machine has started, only the running pilot light stays on. When the program has finished, the END light appears.

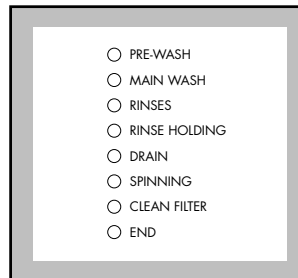

The END pilot light flashes in the event of operating problems.

1 flash = the machine does not fill

2 flashes = the machine does not empty

4 flashes = the door has not been closed

To eliminate the problem, see paragraph “Trouble-Shooting Guide”.

9 Programme selector dial

The selector is divided into following sections:

- **COTTON**
- **SYNTHETIC**
- **DELICATE**
- **WOOL**
- Special programs from **DELICATE RINSE** to **MINIPROGRAM 30**
- Reset/Off program **OFF**

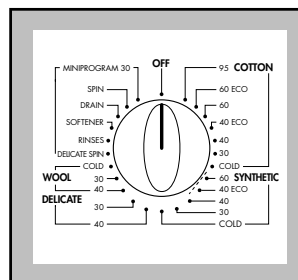

The selector dial can be turned either clockwise or anticlockwise.

ECO corresponds to the energy saving program, and **COLD** to "cold wash".

At the end of the program the selector dial must be turned to the OFF position.

Programme information

RINSES

With this program, it is possible to rinse and spin garments which have been washed by hand. The machine performs 3 rinses, followed by a final spin at maximum speed.

The spin speed can be reduced by depressing the SPIN SPEED Button.

The final spin is foreseen only for cotton items.

DRAIN

For emptying out water from the last rinse when the RINSE HOLD option is selected, turn first the program selector dial to **OFF** then select program drain and depress the **START/PAUSE** button.

SPIN

Select the SPIN program for hand washed cottons. You can reduce the spin speed by depressing the spin speed button to suit the fabric of your garment.

DELICATE SPIN

Select the DELICATE SPIN program for hand washed synthetics, delicates or wool. A short spin at 700rpm maximum is recommended. You can reduce the spin speed by depressing the spin speed button to suit the fabric of your garment.

SOFTENER

Hand washed garments can be softened with this program.

The machine performs 1 rinse, followed by a final spin at max speed, which can be reduced by depressing the SPIN SPEED button.

MINIPROGRAM 30

This is a complete program that can be combined with SPIN SPEED reduction and RINSE HOLD options.

For lightly soiled, or garments which need freshening up.

Max. load: 3 kg.

Washing temperature: 30 C.

Programme duration: 30 minutes.

2 rinses

Final spin speed: 700 rpm.

OFF

To reset a program or switch the machine off, turn the selector dial to **OFF**.

A new program can now be selected.

i Washing hints

Sorting the laundry

Follow the wash code symbols on each garment label and the manufacturer's washing instructions. Sort the laundry as follows: whites, colours, synthetics, delicates, woollens.

Temperatures

90°-95° for normally soiled white cottons and linen (e.g. tea cloths, towels, tablecloths, sheets...)

60° for normally soiled, colour fast garments (e.g. shirts, night dresses, pyjamas....) in linen, cotton or synthetic fibres and for lightly soiled white cotton (e.g. underwear).

Cold 30°-40° for delicate items (e.g. net curtains), mixed laundry including synthetic fibres and woollens.

The wool wash cycle of this machine has been approved by Woolmark for the washing of machine washable Woolmark products provided that the garments are washed according to the instructions on the garment label and those issued by the manufacturer of this washing machine. Licence No. M9604.

Before loading the laundry

Never wash whites and colours together. Whites may lose their "whiteness" in the wash.

New colour items may run in the first wash, they should therefore be washed separately the first time.

Make sure no metal objects are left in the laundry (e.g. hair clips, safety pins, pins).

Button up pillowcases, close zip fasteners, hooks and poppers. Tie any belts or long tapes.

Remove persistent stains before washing. Rub particularly soiled areas with a special detergent or detergent paste.

Treat curtains with special care. Remove hooks or tie them up in a bag or net.

Maximum loads

Recommended loads are indicated in the program charts.

General rules:

Cotton, linen: drum full but not too tightly packed;

Synthetics: drum no more than half full;

Delicate fabrics and woollens: drum no more than one third full.

Washing a maximum load makes the most efficient use of water and energy.

For heavily soiled laundry, reduce the load size.

Laundry weights

The following weights are indicative:

bathrobe	1200 g
napkin	100 g
quilt cover	700 g
sheet	500 g
pillow case	200 g
tablecloth	250 g
towelling towel	200 g
tea cloth	100 g
night dress	200 g
ladies' briefs	100 g
men's work shirt	600 g
men's shirt	200 g
men's pyjamas	500 g
blouse	100 g
men's underpants	100 g

Removing stains

Stubborn stains may not be removed by just water and detergent. It is therefore advisable to treat them prior to washing.

Blood: treat fresh stains with cold water. For dried stains, soak overnight in water with a special detergent then rub in the soap and water.

Oil based paint: moisten with benzine stain remover, lay the garment on a soft cloth and dab the stain; treat several times.

Dried grease stains: moisten with turpentine, lay the garment on a soft surface and dab the stain with the fingertips and a cotton cloth.

Rust: use oxalic acid dissolved in hot water or rust removing product cold. Be careful with rust stains which are not recent since the cellulose structure will already have been damaged and the fabric tends to hole.

Mould stains: treat with bleach, rinse well (whites and fast coloureds only).

Grass: soap lightly and treat with bleach (whites and fast coloureds only).

Ball point pen and glue: moisten with acetone (*), lay the garment on a soft cloth and dab the stain.

Lipstick: moisten with acetone as above, then treat stains with methylated spirits. Remove any residual marks from white fabrics with bleach.

Red wine: soak in water and detergent, rinse and treat with acetic or citric acid, then rinse. Treat any residual marks with bleach.

Ink: depending on the type of ink, moisten the fabric first with acetone (*), then with acetic acid; treat any residual marks on white fabrics with bleach and then rinse thoroughly.

Tar stains: first treat with stain remover, methylated spirits or benzine, then rub with detergent paste.

Do not machine wash garments saturated with petroleum, methylated spirits, trichlorethylene, etc. If such fluids have been used to remove stains prior to washing, wait until they have completely evaporated from the fabric before placing garments in the appliance
(* do not use acetone on artificial silk).

Detergents and additives

Good washing results depends on the choice of detergent and use of the correct quantities to avoid waste and protect the environment. Although biodegradable, detergents contain substances which, in large quantities, can upset the delicate balance of nature.

The choice of detergent will depend on the type of fabric (delicates, woollens, cottons, etc.), the colour fastness, washing temperature and degree of soiling.

All commonly available washing machine detergents may be used in this appliance:

- powder detergents for all types of fabric,
- powder detergents for delicate fabrics (60°C max) and woollens,

The detergent and any additives must be placed in the appropriate compartments of the dispenser drawer before starting the wash program.

If using compact (concentrate) detergents, do not select a prewash program.

If a dosage ball/device is supplied with your concentrate detergent, measure the detergent into the device/ball which should then be placed on top of the laundry and at the back of the machine drum.

Any fabric softener or starching additives must be poured into the compartment marked  before starting the wash program.

Follow the product manufacturer's recommendations on quantities to use and **do not exceed the «MAX» mark in the detergent dispenser drawer.**

Quantity of detergent to be used

Detergent quantity depends on the load size, degree of soiling and hardness of the water.

Water hardness is classified by "degrees" of hardness. Information on water hardness can be obtained from the relevant water authorities.

Follow the product manufacturers' instructions on quantities to use.

Not enough washing powder causes:

- the washload to turn grey,
- greasy clothes.

Too much washing powder causes:

- suds,
- reduced agitation and washing effect,
- inadequate rinsing,

Use less detergent if:

- you are washing a small load,
- the laundry is lightly soiled,
- large amounts of foam form during washing.

i Operating sequence

Before the first wash we recommend that you pour 2 litres of water into the main wash compartment  of the detergent drawer in order to activate the ECO valve. Then run a cotton cycle at 60°C, with the machine empty, in order to remove any manufacturing residue from the drum and tub. Pour half a measure of detergent into the main wash compartment and start up the machine.

1. Place the laundry in the drum

Open the door.

Place the laundry in the drum, one item at a time, shaking them out as much as possible.

Close the door.

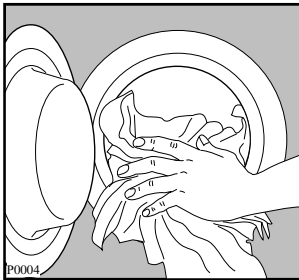

2. Measure out the detergent

Pull out the dispenser drawer until it stops. Measure out the amount of detergent recommended by the manufacturer in a graduated cup and pour it into the main wash compartment .

If you wish to carry out a program with prewash, pour detergent into the appropriate compartment marked .

Please do not use liquid detergent with this appliance except if placed in the dosage ball/device & at the back of the machine drum.

3. Measure out the additive

If required, pour fabric softener into the compartment marked , without exceeding the «MAX» mark.

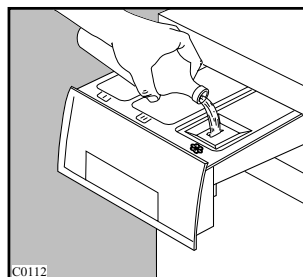
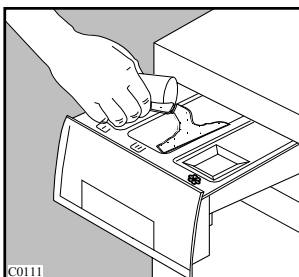

4. Switch the machine on and select the desired program

Turn the selector dial to the desired program to switch the appliance on. The lights corresponding to the different phases making up the selected program light on.

To switch the appliance off turn it to **OFF**.

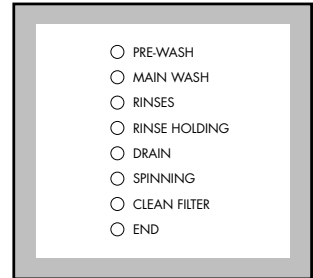
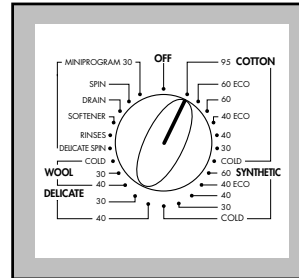

5. Select the spin speed or NO SPIN option

Press the SPIN SPEED button repeatedly, in order to select the desired spin speed or the NO SPIN option. The relevant light will light up.

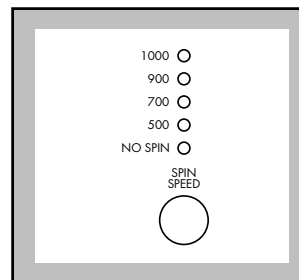

6. Select the desired options

The light corresponding to the depressed button illuminates.

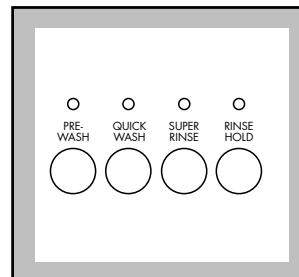

7. Start the program

Press the **START/PAUSE** button. The relevant light will stop flashing. Only the light relevant to the phase in progress will remain lit.

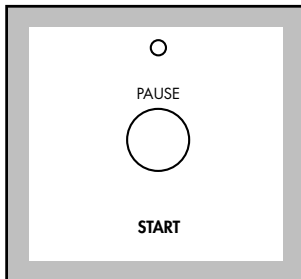

8. Altering a program

You can alter the program before it starts. When the program has started, you can only reset it by turning the program selector dial to **OFF**, you can then select a new program. Start it by depressing the **START/PAUSE** button.

9. Interrupting a program

Depress the **START/PAUSE** button to interrupt the running program, the corresponding light will flash, press the **START/PAUSE** button again to restart the program.

10. Cancelling a program

Turn the selector dial to **OFF** to cancel a program which is running. Now you can select a new program.

11. Opening the door after the program has started

Pause the machine by pressing the **START/PAUSE** button.

If the door does not open, this means the machine is already heating, the water level is above the bottom edge of the door or the drum is turning.

If you can not open the machine door, but need to, switch off the machine and turn the selector dial to **OFF**. After 3 minutes the door can be opened (pay attention to the water level and temperature). To restart turn the selector dial to the previous program selected (select again the options required) and press the **START/PAUSE** button.

12. At the end of the program

The machine stops automatically.

If the RINSE HOLD option has been selected the porthole remains locked, the light of the **START/PAUSE** button goes off, RINSE HOLDING pilot light and RINSE HOLD light remain alight, to indicate the water must be drained before opening the door.

Turn the program selector dial to Reset **OFF** to switch the machine off.





















Remove the laundry from the drum and carefully check the drum is empty to avoid any forgotten items being damaged in a subsequent wash (e.g shrinking) or their colour running into a load of whites.

If you do not intend to carry out another wash, close the water tap.

Leave the door open to prevent the formation of mildew and unpleasant smells.









Washing Programmes

Washing programs for cotton, linen and synthetics

Programme/ Temperature	Type of fabric	Programme description	Additional functions	Dispenser- washing agents
COTTON 95°	White cotton	Wash at 95°C 3 rinses Long spin	Prewash Quick wash Rinse Hold Super rinse Spin/ NO SPIN	 *  
COTTON 60° ECO	Cotton Economy	Wash at 60°C 3 rinses Long spin	Prewash Rinse Hold Super rinse Spin/NO SPIN	 *  
COTTON 60°	Lightly soiled whites and fast coloureds	Wash at 60°C 3 rinses Long spin	Prewash Quick wash Rinse Hold Super rinse Spin/NO SPIN	 *  
COTTON 40° ECO	Lightly soiled non-fast coloureds Economy	Wash at 40°C 3 rinses Long spin	Prewash Rinse Hold Super rinse Spin/NO SPIN	 *  
COTTON 40°- 30°- COLD	Non-fast coloureds	Wash at 40°-30°C or Cold wash 3 rinses Long spin	Prewash Quick wash Rinse Hold Super rinse Spin/NO SPIN	 *  
SYNTHETIC 60°- 40°-30°- COLD	Synthetics	Wash at 60°-40°-30°C or Cold wash 3 rinses Short spin	Prewash Quick wash Rinse Hold Super rinse Spin/NO SPIN	 *  
SYNTHETIC 40° ECO	Synthetics Economy	Wash at 40° 3 rinses Short spin	Prewash Rinse Hold Super rinse Spin/NO SPIN	 *  

* With PREWASH option

Washing programs for delicates and wool













Programme/ Temperature	Type of fabric	Programme description	Additional functions	Dispenser- washing agents
DELICATE 40°- 30°	Delicate fabrics	Wash at 40°-30°C 3 rinses Short spin	Prewash Quick wash Rinse Hold Super rinse Spin/NO SPIN	 *  
WOOL 40°- 30° - COLD	Wool 	Wash at 40°-30°C -Cold 3 rinses Short spin	Rinse Hold Spin/NO SPIN	 
MINIPROGRAM 30	Short cycle for lightly soiled fabrics	Wash at 30°C 2 rinses Short spin	Rinse Hold Spin/NO SPIN	 



Special programs





Position on the selector/ Programme	Programme description	Additional functions
RINSES For rinses hand washed items	3 rinses with liquid additive, if required Long spin at max. speed	Rinse Hold Super rinse Spin/NO SPIN
SOFTENERS	1 rinse with liquid softener, if required Long spin at max. speed	Rinse Hold Spin/NO SPIN
DRAIN For emptying out the water of the last rinse of programs with option RINSE HOLD	Water draining	Spin
SPIN Separate spin for cottons	Drain and long spin at max. speed	Spin
DELICATE SPIN Separate short spin for synthetics, delicates, wool and handwash	Drain and delicate spin	
OFF Reset/Off For cancelling the program which is running or to switch the machine off		





i International wash code symbols







These symbols appear on fabric labels, in order to help you choose the best way to treat your laundry.

Energetic wash   Delicate wash	 Max. wash temperature 95°C	 Max. wash temperature 60°C	 Max. wash temperature 40°C	 Max. wash temperature 30°C	 Hand wash	 Do not wash at all
	 60	  40 40	 30			

 Bleaching	 Bleach in cold water	 Do not bleach
---	---	--

 Ironing	 Hot iron max 200°C	 Warm iron max 150°C	 Lukewarm iron max 110°C	 Do not iron
---	--	---	--	--

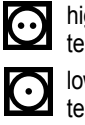
 Dry cleaning	 Dry cleaning in all solvents	 Dry cleaning in perchlorethylene, petrol, pure alcohol, R 111 & R 113	 Dry cleaning in petrol, pure alcohol and R 113	 Do not dry clean
--	--	---	---	--

 Drying	 Flat	 On the line	 On clothes hanger	 high temperature  low temperature Tumble dry	 Do not tumble dry
--	---	--	---	---	---

Maintenance



Before any maintenance or cleaning is carried out you must **DISCONNECT** the appliance from the electricity supply.

After each wash

Leave the door open for a while. This helps to prevent mould and stagnant smells forming inside the appliance. Keep the door open after a wash will also help to preserve the door seal.

Maintenance Wash

Low temperature washes can cause the build up of residue inside the drum. We recommend a maintenance wash be performed on a regular basis.

To run a maintenance wash:

- The drum should be empty of laundry.
- Select the hottest cotton wash program.
- Use a normal measure of detergent which must be powder.

Door seal

From time to time check the door seal to eliminate objects trapped in the fold.

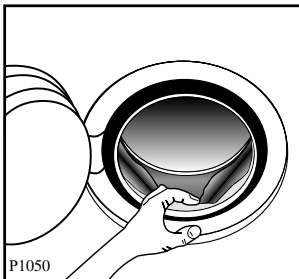

Cabinet

Clean the outside of the washing machine with warm water and dish detergent. Rinse with clean water and dry with a soft cloth.

Important: do not use methylated spirits, solvents or similar products to clean the bodywork.

Detergent dispenser drawer

After a while, detergents and fabric softeners leave deposits in the drawer. Inspect the drawer regularly.

To remove the drawer from the machine, press the button in the rear left-hand corner.

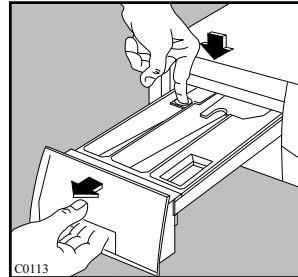

To facilitate cleaning, the top part of the additive compartment can be removed.

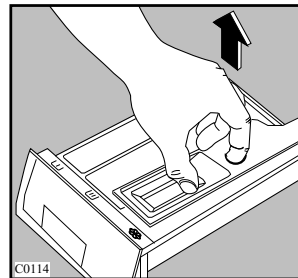

Clean the drawer by rinsing it under a running tap.

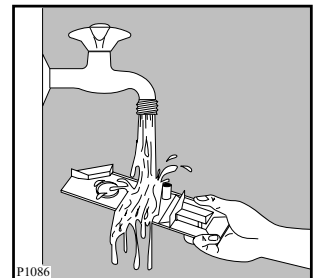
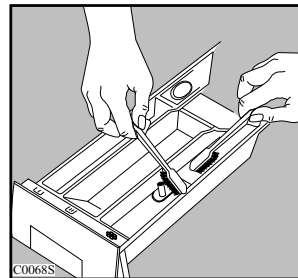

Detergent can also accumulate inside the drawer recess: clean it with an old toothbrush. Refit the drawer after cleaning.

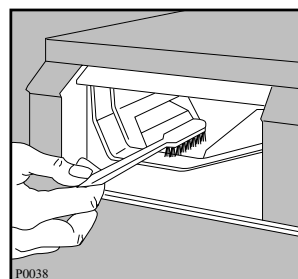

Drain pump

The pump should be inspected if

- the machine does not empty and/or spin
- the machine makes an unusual noise during draining due to objects such as safety pins, coins etc. blocking the pump.

Proceed as follows:

- Disconnect the appliance.
- If necessary wait until the water has cooled down.
- Open the pump door.

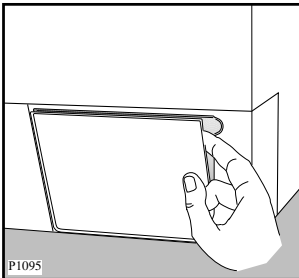

- Place a container close to the pump to collect any spillage.
- Release the emergency emptying hose, place it in the container and remove its cap.
- When no more water comes out, unscrew the pump guard and remove it. Always keep a rag nearby to dry up spillage of water when removing the pump guard.

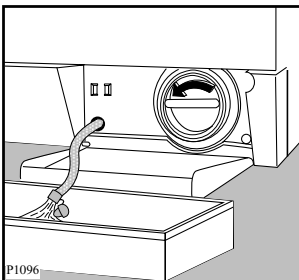

- Remove any objects from the pump impeller by rotating it.

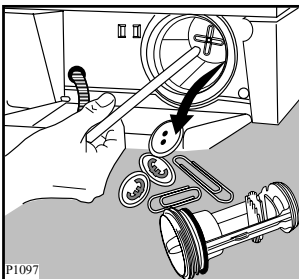

- Put the cap back on the emergency emptying hose and place the latter back in its seat.

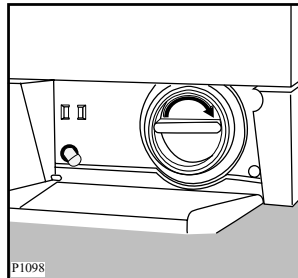

- Screw the pump guard fully in.
- Close the pump door.

Important!

Every time you drain the water through the emergency emptying hose you must pour 2 litres of water into the main wash compartment of the detergent drawer and then run the drain program. This will activate the ECO valve avoiding that part of the detergent remains unused for the next wash.

Water inlet filter

If you notice that the machine is taking longer to fill, check that the filter in the water inlet hose is not blocked.

Turn off the water tap.

Unscrew the hose from the tap.

Clean the filter with a stiff brush.

Screw the hose back onto the tap.

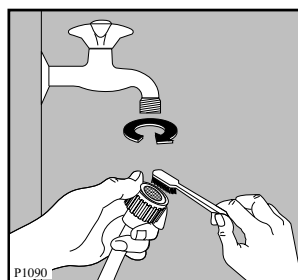

Emergency emptying out

If the water is not discharged, proceed as follows to empty out the machine:

- pull out the plug from the power socket;
- close the water tap;
- if necessary, wait until the water has cooled down;
- open the pump door;
- place a bowl on the floor and place the end of the emergency emptying hose into the bowl. Remove its cap. The water should drain by gravity into the bowl. When the bowl is full, put the cap back on the hose. Empty the bowl. Repeat the procedure until water stops flowing out;
- clean the pump guard if necessary as previously described;
- replace the emergency emptying hose in its seat after having plugged it;
- screw the drain filter fully in and close the door.

The dangers of freezing

If the machine is installed in a place where the temperature could drop below 0°C, proceed as follows:

- Remove the plug from the socket.
- Close the water tap and unscrew the water inlet hose from the tap.
- Place the end of the emergency emptying hose and that of the inlet hose in a bowl placed on the floor and let water drain out.
- Screw the water inlet hose back on and reposition the emergency emptying hose after having put the cap on again.

By doing this, any water remaining in the machine is removed, avoiding the formation of ice and, consequently, breakage of the affected parts.

When you use the machine again, make sure that the ambient temperature is above 0°C.

Trouble-Shooting Guide

Certain problems are due to lack of simple maintenance or oversights, which can be solved easily without calling out a service technician. Before contacting your local Service Centre, please carry out the checks listed below.

During machine's operation it is possible that the END pilot light will flash:

1 flash = the machine does not fill

2 flashes = the machine does not empty

4 flashes = the door has not been closed

Once the problem has been eliminated, press the **START/PAUSE** button to restart the program. If after all checks, the problem persists, contact your local Service Centre.

Problem	Possible cause
<ul style="list-style-type: none"> • The machine does not start up: 	<ul style="list-style-type: none"> • The door is not firmly closed. • The machine is not plugged in or there is no power at the socket. • The main fuse blown. • The START PAUSE button has not been depressed.
<ul style="list-style-type: none"> • The machine does not fill: 	<ul style="list-style-type: none"> • The water tap is closed. • The inlet hose is squashed or kinked. • The filter in the inlet hose is blocked. • The door is not properly closed.
<ul style="list-style-type: none"> • The machine fills then empties immediately: 	<ul style="list-style-type: none"> • The end of the drain hose is too low. Refer to relevant paragraph in "water drainage" section.
<ul style="list-style-type: none"> • The machine does not empty and/or does not spin: 	<ul style="list-style-type: none"> • The drain hose is squashed or kinked. • The RINSE HOLD option has been selected. • The drain pump is clogged. • The NO SPIN option has been selected.
<ul style="list-style-type: none"> • There is water on the floor: 	<ul style="list-style-type: none"> • Too much detergent or unsuitable detergent (creates too much foam) has been used. • Check whether there are any leaks from one of the inlet hose fittings. It is not always easy to see this as the water runs down the hose; check to see if it is damp. • The drain hose is damaged. • The pump guard has not been fully screwed in. • The cap on the emergency emptying hose has not been replaced after cleaning the pump.
<ul style="list-style-type: none"> • Unsatisfactory washing results: 	<ul style="list-style-type: none"> • Too little detergent or unsuitable detergent has been used. • Stubborn stains have not been treated prior to washing. • The correct program / temperature was not selected. • Excessive laundry load.
<ul style="list-style-type: none"> • The machine vibrates or is noisy: 	<ul style="list-style-type: none"> • The transit bolts and packing have not been removed. • The support feet have not been adjusted. • The laundry is not evenly distributed in the drum. • Maybe there is very little laundry in the drum.

Problem	Possible cause
<ul style="list-style-type: none"> • The door will not open: 	<ul style="list-style-type: none"> • The program is still running, the drum is turning. • The door lock has not yet released. • The water level is above the bottom edge of the door. • The machine is heating the water.
<ul style="list-style-type: none"> • Spinning starts late or the laundry is not spun enough: 	<ul style="list-style-type: none"> • The electronic unbalance detection device has cut in because the laundry is not evenly distributed in the drum. The laundry is redistributed by reverse rotation of the drum. This may happen several times before the unbalance disappears and normal spinning can resume. If, after few minutes, the laundry is still not evenly distributed in the drum, the machine will spin at a lower speed or will not spin. If at the end of the program the laundry is not spun enough, redistribute the load manually and select the spin program.
<ul style="list-style-type: none"> • No water is visible in the drum 	<ul style="list-style-type: none"> • Machines based on modern technology operate very economically using very little water without affecting performance.
<ul style="list-style-type: none"> • The machine makes an unusual noise 	<ul style="list-style-type: none"> • The machine is fitted with a type of motor which makes an unusual noise compared with other traditional motors. This new motor ensures a softer start and more even distribution of the laundry in the drum when spinning, as well as increased stability of the machine.

If you are unable to identify or solve the problem, contact your nearest service centre. Before telephoning, make a note of the model, serial number and purchase date of your machine: the Service Centre will require this information.

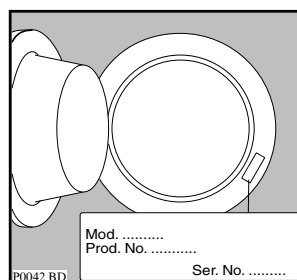

WESTINGHOUSE APPLIANCE WARRANTY – NEW ZEALAND

This appliance is warranted by Electrolux Home Products (NZ) Ltd (“the Company”) from the date of purchase. The following terms and conditions apply:

- 1 The Company or its Authorised Service Centre will pay the cost of repairing or replacing all parts of the appliance which the Company or its Authorised Service Centre find defective for a period of 24 months following the date of purchase (the “Warranty Period”).
- 2 During the Warranty Period the Company or its Authorised Service Centre, will pay the cost of repairing or replacing all parts, which they find are defective.
- 3 Light globes, batteries and filters are replaceable parts and are not covered under this warranty.
- 4 The appliance must be installed and operated in accordance with the Company’s instructions.
- 5 This Warranty does not apply to normal wear and tear, or any service, which is needed after an accident, negligence, alteration or misuse.
- 6 This Warranty also does not apply to damage caused if your appliance has been dismantled, repaired or serviced by any person other than someone authorised by the Company.
- 7 If you live outside the service area of the Company or its Authorised Service Centre, this warranty does not cover the cost of transport of the appliance for service nor the Authorised Service Centre’s travelling costs to and from your home.
- 8 If you are required to transport the appliance to the Company or its Authorised Service Centre, it must be securely packed and insured. The Company does not accept any responsibility for loss or damage prior to it being received by the Company or its Authorised Service Centre.
- 9 This warranty is the only express warranty given by the Company.
- 10 This Warranty does not cover loss, damage or expense to this appliance caused directly or indirectly by power surges, electrical storm damage or incorrect power supply.
- 11 The Company (and any company related to the Company) will not be liable for any special incidental or consequential damages or for loss, damage or expense directly or indirectly arising from the use or inability to use this appliance, or for personal injury or loss or destruction of other property.
- 12 Nothing in this warranty is intended to limit the rights you may have under the Consumer Guarantees Act 1993, except to the extent permitted by that Act, and all provisions of this warranty shall be read as modified to the extent necessary to give effect to that intention.
- 13 The Consumer Guarantees Act 1993 does not apply if your appliance is acquired for the purposes of a “business” (as defined in that Act).
- 14 This warranty is limited to 90 days from date of purchase if the appliance is used for commercial use.

IMPORTANT NOTICE

Before calling a service technician please carefully check the warranty terms and conditions, the operating instructions and service booklet if applicable. If the product fails for any of the customer responsibility reasons detailed therein, a service fee will be charged. Please present proof of purchase to any **Authorised** Service Centre should warranty service be required.

<p style="text-align: center;">SERVICE CENTRES PLEASE PHONE 0800 10 66 10</p>
--

For your nearest Authorised
Service Centre please look in
The Yellow Pages under
Home Appliance Servicing
OR
Call 0800 10 66 10

WESTINGHOUSE WARRANTY AUSTRALIA

Nothing in this warranty, limits any rights you may have under the Trade Practices Act or any other Commonwealth or State legislation. Such rights cannot be changed by the conditions in this warranty.

Subject to the conditions below, this appliance is warranted by Electrolux Home Products Pty. Ltd. A.B.N. 51 004 762 341, (the "Company"), to be free from defects in materials and workmanship for a period of 24 months following the date of purchase (the "Warranty Period").

Conditions of the warranty:

- 1 During the Warranty Period the Company, or its service agent, will only pay the cost of repairing or replacing all Company parts on your appliance which the Company finds to be defective.
- 2 The Company will decide if there are any defects in material and/or workmanship.
- 3 Light globes, batteries and filters are replaceable parts and are not covered under this warranty.
- 4 This warranty applies only for mainland Australia and Tasmania.
- 5 The appliance must be installed and operated in accordance with the Company's instructions.
- 6 This warranty does not apply to normal wear and tear, or any service, which is needed after an accident, alteration, negligence, misuse, fire or flood.
- 7 This warranty does not apply to damage caused if your appliance has been dismantled, repaired or serviced by any person other than someone authorised by the Company.
- 8 If you live outside the service area of the Company or one of its service agents, this warranty does not cover the cost of transport of the appliance for service nor the service agent's travelling costs to and from your home.
- 9 If you are required to transport the appliance to the Company or its service agent, you must ensure it is securely packed and insured. The Company does not accept any responsibility for loss or damage of the appliance prior to it being received by the Company or its service agent.
- 10 This warranty does not cover loss, damage or expense to this appliance caused directly or indirectly by power surges, electrical storm damage or incorrect power supply.
- 11 The Company (and any company related to the Company) will not be liable for any special, incidental or consequential damages or for loss, damage or expense or for personal injury or loss or destruction of property arising directly or indirectly from the use or inability to use this appliance or any of its parts.
- 12 This warranty applies only to the original buyer.
- 13 This warranty is the only express warranty given by the Company.
- 14 If you are the original buyer, please keep your proof of purchase, which will be required, if you request service under this warranty.
- 15 The Warranty Period is only applicable when your appliance is used at home by you and your family.
- 16 Use of this appliance for commercial purposes is covered by this warranty for a period of 3 months from the date of purchase.

**FOR SERVICE IN AUSTRALIA
PLEASE CALL
13 13 49**

**FOR SPARE PARTS IN AUSTRALIA
PLEASE CALL
13 13 50**

 **The Electrolux Group. The world's No. 1 Choice.**

The Electrolux Group is the world's largest producer of powered appliances for kitchen, cleaning and outdoor use. More than 55 million Electrolux Group products (such as refrigerators, cookers, washing machines, vacuum cleaners, chain saws and lawn mowers) are sold each year to a value of approx. USD 14 billion in more than 150 countries around the world.